



Sensata
Technologies



AIRPAX[®]
POWER PROTECTION CATALOG

this page was intentionally left blank

| Product | Description | Poles | Current & Voltage Rating | Operating Temperature | Approvals* | Page |
|--|--|-------|--|---|---|------------|
|  6600 Series | <ul style="list-style-type: none"> Sub-miniature bimetal thermostat 8-PIN DIP package configuration Snap-acting trip mechanism increases operational life | SPST | <ul style="list-style-type: none"> 1.0A max at 48VDC 25,000 cycles 1.0A max at 120VAC 30,000 cycles 0.020A max at 5VDC 100,000 cycles (gold) | <ul style="list-style-type: none"> 40°C to 130°C (104°F to 266°F) | <ul style="list-style-type: none"> cRUus VDE approved | 33 |
|  6700 Series | <ul style="list-style-type: none"> Sub-miniature bimetal thermostat TO-220 package configuration Snap-acting trip mechanism increases operational life VDE approved "P" version | SPST | <ul style="list-style-type: none"> 0.5A max at 48VDC 20,000 cycles 0.001A max at 5VDC 100,000 cycles (gold) | <ul style="list-style-type: none"> 40°C to 130°C (104°F to 266°F) | <ul style="list-style-type: none"> cRUus VDE ("P" option) | 37 |
|  IAR Series | <ul style="list-style-type: none"> 1U (1RU) hydraulic magnetic circuit breaker Low-profile design Auxiliary switch options available for alarm signaling | 2 | <ul style="list-style-type: none"> 50A max at 80 VDC / 250 VAC 30A max, 120/240VAC (2 poles) | <ul style="list-style-type: none"> 5000A, 65VDC 5000A, 80VDC 2000A, 250VAC 5000A, 120/240VAC (2 poles) 5000A, 80VDC (2 poles) | <ul style="list-style-type: none"> C-UL recognized UL1077 recognized UL489A listed TUV approved | 42 |
|  SNAPAK® | <ul style="list-style-type: none"> Compact magnetic-hydraulic circuit protector Aesthetically pleasing for front panel mounting Toggle, rocker, push-pull and push-to-reset actuation options | 2 | <ul style="list-style-type: none"> 7.5A max at 50 VDC / 250 VAC 30A max at 32 VDC / 120 VAC 25A max at 120/240 VAC (two poles) 20A max at 250 VAC (50/60 Hz, at 500AIC) 20A max at 65 VDC [two poles, at 500AIC] | <ul style="list-style-type: none"> 1000A | <ul style="list-style-type: none"> UL recognized CSA certified TUV approved CE compliant CCC approved | 54 |
|  AP Series | <ul style="list-style-type: none"> QPL to MIL-PRF-39019 Sealed magnetic-hydraulic circuit protection Can withstand 100G shock repeatedly Ideal for use in Class 1, Div. 2 Groups A, B, C & D hazardous locations | 3 | <p>AP ratings</p> <ul style="list-style-type: none"> 20A max at 50 VDC / 240 VAC <p>UP ratings (1 pole only)</p> <ul style="list-style-type: none"> 20A max at 50 VDC 15A max at 120 VAC 7.5A max at 240 VAC | <p>AP ratings</p> <ul style="list-style-type: none"> 500A, 50 VDC, 120 VAC 300A, 240 VAC <p>UP ratings</p> <ul style="list-style-type: none"> 1000A, 50VDC, 240 VAC | <ul style="list-style-type: none"> MIL-PRF-M39019 UL recognized (UP type only) FM approved (UP type only) | 70 |
|  IPA Series | <ul style="list-style-type: none"> Compact magnetic-hydraulic circuit protection Quick-connect, screw, PC board mount terminals Auxiliary switch options Multi-pole options with multi or single handle | 4 | <ul style="list-style-type: none"> 30A max at 65 VDC / 240 VAC 20A max at 80 VDC (300 AIC) 25A max at 250 VAC, 50/60 Hz 15A max at 250 VAC, 400 Hz 25A max at 65 VDC / 250 VAC, (TUV) 15A max at 250 VAC, 400 Hz (TUV) | <ul style="list-style-type: none"> 1000A | <ul style="list-style-type: none"> UL 489A listed (CPA) UL recognized CUR recognized TUV certified CE compliant CCC approved (pending) | 82 |
|  IAG Series | <ul style="list-style-type: none"> IEG versions meet IEC spacing requirements for installation in equipment that must comply with IEC 601 and 950, and VDE 0730, 0804 and 0805 Multi-pole options with multi or single handle Auxiliary switch options Mid-trip handle option Snap-in mounting option Dual frequency delay options | 6 | <ul style="list-style-type: none"> 50A max at 80 VDC 50A max at 240 VAC 30A max at 277 VAC, 50/60 Hz 30A max at 250 VAC, 400 Hz 30A max at 125 VAC, 50/60 Hz 30A max at 120/240 VAC, 50/60 Hz | <ul style="list-style-type: none"> 5000A, 240 VAC, 50/60 Hz 1500A, 250 VAC, 400 Hz 7500A, 80 VDC (IEG) 5000A, 80 VDC (CEG) 2000A, 250 VAC, 50/60 Hz (VDE) 4000A, 80 VDC (VDE) 5000A, 125 VAC, 50/60 Hz (LEG) 5000A, 120/240 VAC, 50/60 Hz (LEG) | <ul style="list-style-type: none"> UL 489 listed (LEG) UL 489A listed (CEG) UL recognized CSA certified VDE available CE compliant CCC approved UL 1500 certified QPL to MIL-PRF-55629 | 98 |
|  LEGA Series | <ul style="list-style-type: none"> LEGA is a new "low depth" version of our standard IAG series hydraulic magnetic circuit breaker | 6 | <ul style="list-style-type: none"> 50A max at 80 VDC 50A max at 240 VAC 30A max at 277 VAC, 50/60 Hz 30A max at 250 VAC, 400 Hz 30A max at 125 VAC, 50/60 Hz 30A max at 120/240 VAC, 50/60 Hz | <ul style="list-style-type: none"> 5000A, 240 VAC, 50/60 Hz 1500A, 250 VAC, 400 Hz 7500A, 80 VDC (IEG) 5000A, 80 VDC (CEG) 2000A, 250 VAC, 50/60 Hz (VDE) 4000A, 80 VDC (VDE) 5000A, 125 VAC, 50/60 Hz (LEG) 5000A, 120/240 VAC, 50/60 Hz (LEG) | <ul style="list-style-type: none"> UL 489 listed (LEG) UL 489A listed (CEG) UL recognized CSA certified VDE available CE compliant CCC approved UL 1500 certified QPL to MIL-PRF-55629 | 122 |
|  LEJ Series | <ul style="list-style-type: none"> 240 VAC hydraulic magnetic circuit breaker UL489 listed Optional LEJA "low depth" version | 2 | <ul style="list-style-type: none"> 20A max at 240 VAC | <ul style="list-style-type: none"> 5000A, 240 VAC, 50/60 Hz | <ul style="list-style-type: none"> UL 489 TUV certified | 132 |

| Page | Product | Description | Poles | Current & Voltage Rating | Interrupting Capacity | Approvals* |
|------|---|---|---------|--|--|---|
| 146 | IAL Series  | <ul style="list-style-type: none"> • IEL versions meet IEC spacing requirements for installation in equipment that must comply with IEC 601 and 950 and VDE 0730, 0804 and 0805 • Multi-pole options with multi or single handle • Auxiliary switch options • Snap-in mounting option • Mid-trip handle option • Various actuator options • Dual frequency delay options | 6 max | <ul style="list-style-type: none"> • 100A max at 65 VDC • 70A max at 80 VDC • 50A max at 250VDC • 50A max at 300VDC • 70A max at 240 VAC, 50/60 Hz • 50A max at 277 VAC, 50/60 Hz • 50A max at 277/480 VAC, 50/60 Hz • 50A max at 250 VAC, 400 Hz | <ul style="list-style-type: none"> • 5000A, 240 VAC, 50/60 Hz • 1500A, 250 VAC, 400 Hz • 7500A, 80 VDC • 2000A, 240 VAC, 50/60 Hz (VDE) • 2000A, 415 VAC, 50/60 Hz (VDE) • 4000A, 80 VDC (VDE) • 1200A, 277/480 VAC, 50/60 Hz • 5000A, 250VDC • 1000A, 300VDC | <ul style="list-style-type: none"> • UL recognized • CSA certified • VDE approved (IEL) • CE compliant (IEL) • CCC approved • UL 1500 certified • QPL to MIL-PRF- 55629 |
| 146 | LEL Series  | <ul style="list-style-type: none"> • LEL versions meet IEC spacing requirements for installation in equipment that must comply with IEC 601 and 950 and VDE 0730, 0804 and 0805 • Multi-pole options with multi or single handle • Auxiliary switch options • Snap-in mounting option • Mid-trip handle option • Various actuator options • Dual frequency delay options | 3 max | <ul style="list-style-type: none"> • 100A max at 80 VDC • 50A max at 125 VAC, 50/60 Hz • 80A max at 120/240 VAC, 50/60 Hz • 100A max at 80 VDC (VDE) • 50A max at 250 VAC (VDE) | <ul style="list-style-type: none"> • 50000A, 80 VDC • 5000A, 125 VAC • 5000A, 120/240 VAC 50/60 Hz • 2000A, 80 VDC • 2000A, 250 VAC, 50/60 Hz (VDE) • 10000A, 120/240VAC, 50/60 Hz | <ul style="list-style-type: none"> • UL 489 listed • CSA certified • VDE approved • CE compliant • CCC approved |
| 146 | LELP Series  | <ul style="list-style-type: none"> • Unique, parallel current sensing design • Compact size, high current capacity • Auxiliary switch options • Mid-trip handle option | 1 max | <ul style="list-style-type: none"> • 125A at 80 VDC[†] • 150A at 80 VDC[†] • 175A at 80 VDC[†] • 200A at 80 VDC[†] • 250A at 80 VDC[†] • 251A to 300A at 80 VDC^{††} <p>[†] Two paralleled poles ^{††} Three paralleled poles</p> | <ul style="list-style-type: none"> • 10000A, 80 VDC • 50000A, 65 VDC (up to 150 amps) • 10000A, 80 VDC (> 150 amps) | <ul style="list-style-type: none"> • UL 489 listed • UL 489A listed • CSA certified |
| 174 | IELR Series  | <ul style="list-style-type: none"> • Meets IEC spacing requirements for installation in equipment that must comply with IEC 601 and 950, and VDE 0730, 0804 and 0805 • Designed to mount on standard 35mm DIN rails | 4 max | <ul style="list-style-type: none"> • 70A max at 80 VDC • 70A max at 250 VAC, 50/60 Hz • 50A max at 80 VDC (VDE) • 50A max at 250 VAC, 50/60 Hz (VDE) • 30A max at 415 VAC, 50/60 Hz (VDE) | <ul style="list-style-type: none"> • 7500A, 80 VDC • 5000A, 250 VAC, 50/60 Hz • 2000A, 277 VAC, 50/60 Hz • 2000A at 250 VAC, 50/60 Hz (VDE) • 2000A at 415 VAC, 50/60 Hz (VDE) • 4000A at 80 VDC (VDE) | <ul style="list-style-type: none"> • UL recognized • CSA certified • VDE approved (IELR) • CE compliant |
| 186 | 209 Series  | <ul style="list-style-type: none"> • Front or back connected terminal styles • E-frame style model complies with UL 489 • 249 Power Selector Breaker system is listed as a branch circuit breaker per UL 489 • Complies with international requirements • 279 complies with UL 489A | 6 max | <ul style="list-style-type: none"> • 100A max at 160 VDC • 125A max at 125 VDC • 77A max at 600 VAC • 100A max at 347/600 VAC • 100A max at 120, 240, 277, 480 VAC • 100A max, 125 VDC, 240/415 VAC (VDE) | <ul style="list-style-type: none"> • 5000A • 10000A • 4000A (VDE) | <ul style="list-style-type: none"> • UL 489 listed • UL 489A listed (279) • UL recognized • CSA certified • VDE approved • UL1500 certified • CCC approved • CE compliant |
| 204 | JAE Series  | <ul style="list-style-type: none"> • F-frame style complies with UL 489 • Various terminal options for design flexibility • Reduced voltage drop through the circuit breaker compared to other protective devices • Auxiliary switch options • Mid-trip handle options | 6 max | <p>UL489</p> <ul style="list-style-type: none"> • 100A to 250A at 160 VDC • 100A to 250A at 65 VDC • 100A to 250A at 125/250 VDC • 100A to 250A at 240 VAC <p>UL489A</p> <ul style="list-style-type: none"> • 275A to 800A at 160 VDC • 275A to 1200A at 65 VDC | <ul style="list-style-type: none"> • 10000A, 160 VDC • 10000A, 125/250 VDC • 65000A, 65 VDC • 10000A, 240 VAC • 18000A, 240 VAC • 100000A, 65VDC (UL489A up to 800A) | <ul style="list-style-type: none"> • UL 489 listed • UL 489A listed • UL recognized • CSA certified • VDE approved • CCC approved • CE compliant |
| 220 | MDS2 Series  | <ul style="list-style-type: none"> • Modular Distribution System provides unprecedented flexibility • "Hot Plug" modules allow for equipment expansion without power shutdown • Unique alarm conductors simplify signal wiring • Modular load terminals available with front or rear access | 4 to 24 | <ul style="list-style-type: none"> • Maximum load bus rating per position is 100 amps, 125VDC | • See Airpax™ IEL series | • See Airpax™ IEL series |
| 224 | PGFM Series  | <ul style="list-style-type: none"> • GFCI sensing module designed to operate in tandem with the LEL series circuit breaker with a shunt voltage trip and auxiliary switch • Manufactured by North Shore Safety, Ltd., a leader in innovative safety products • Automatic and manual reset configurations • Power and fault status indicators • Double insulated user interface | 3 max | <p>Ground Trip Current</p> <ul style="list-style-type: none"> • 4 to 6 mA <p>Trip Time, Combined Assembly</p> <ul style="list-style-type: none"> • ≤ 25 mS <p>Rated Voltage</p> <ul style="list-style-type: none"> • 120 VAC or 240 VAC, 50/60 Hz <p>Let-Go Voltage</p> <ul style="list-style-type: none"> • 60% of supply voltage | • See Airpax™ LEL series | <ul style="list-style-type: none"> • UL 943, Class A or UL 1053 Compliant |

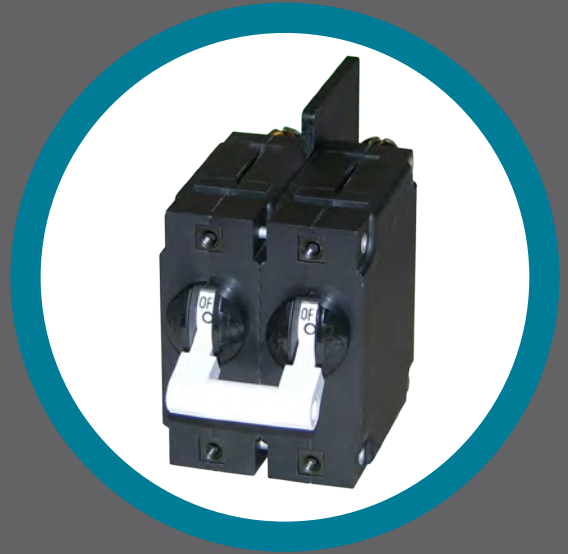
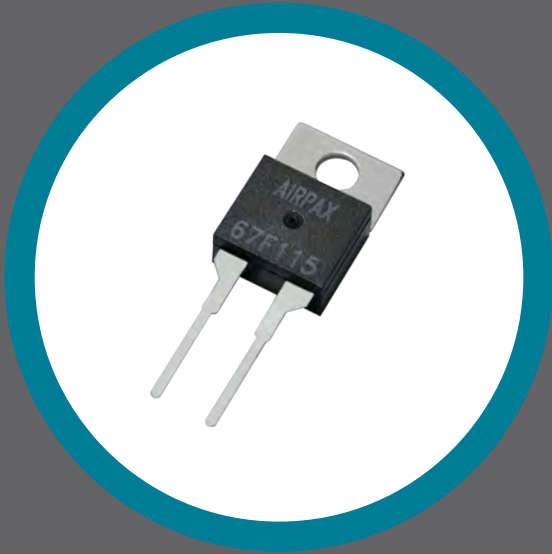

AIRPAX[®]

Guide to Power Protection

| | | |
|---|---|-----------|
| <i>Choice of Circuit Protection</i> | • | 2 |
| <i>How Magnetic Circuit Breakers Work</i> | • | 18 |
| <i>How to use Airpax™ Magnetic Circuit Breakers</i> | • | 22 |
| <i>Designing for the International Market</i> | • | 25 |
| <i>IEC Classes of Electrical Equipment</i> | • | 28 |
| <i>Classes of Insulation</i> | • | 29 |
| <i>Combinations</i> | • | 30 |

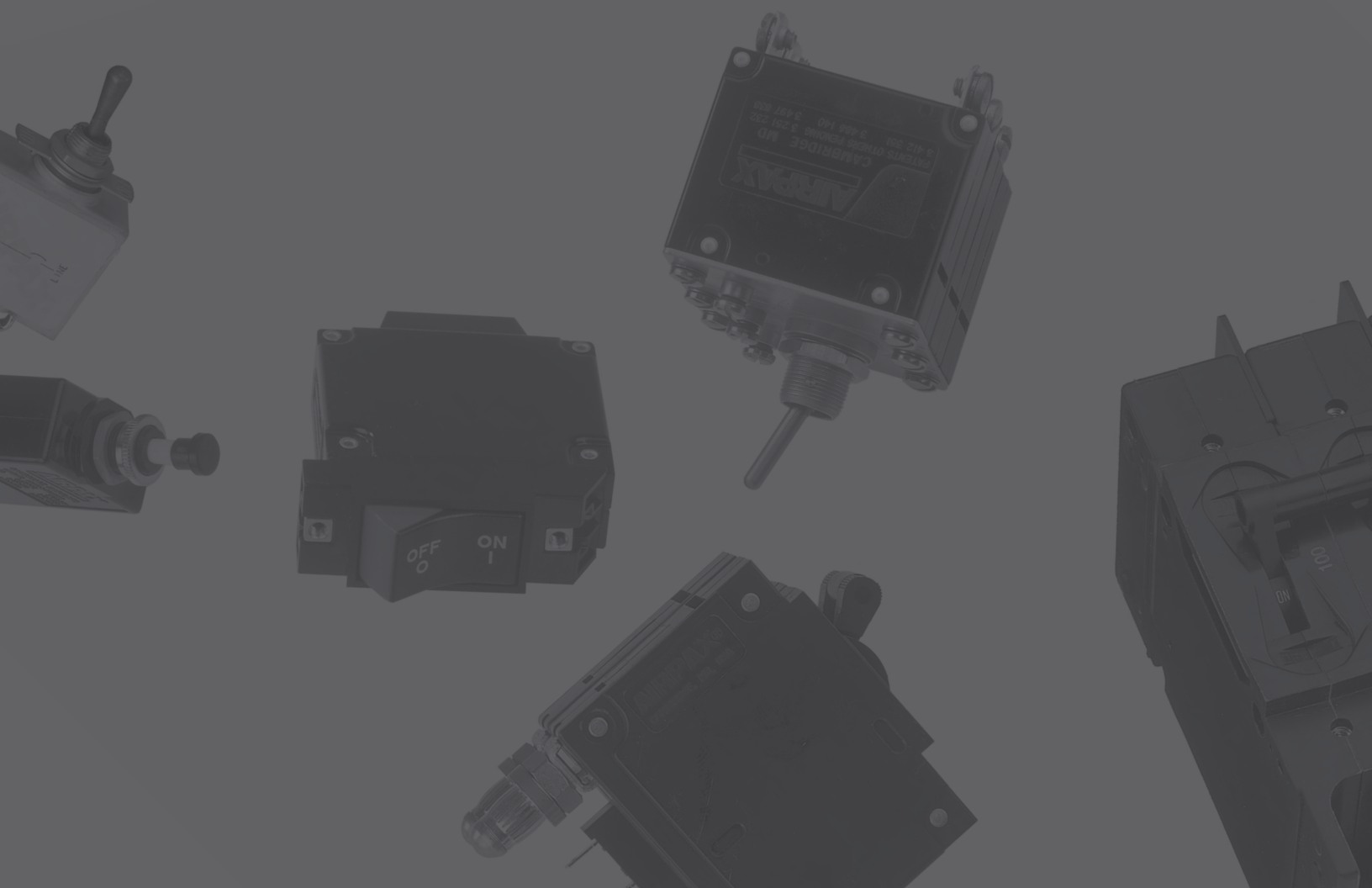

CHOICE OF CIRCUIT PROTECTION

Most electric and electronic devices will destroy themselves if you let them. Since they cannot distinguish between normal loads or overloads, they will just keep drawing more current as the load increases – until they burn themselves out.

Protective devices for electric equipment and circuits act as survival kits. Because of the steadily increasing power being fed into transmission lines, these guardians must often respond fast to protect equipment and branch circuits. Suppliers of protective devices provide a diverse selection of devices to handle the spectrum of traditional protection needs, as well as innovative designs for newer applications with their rapidly changing requirements.

Basically, the “choice of protection” is about magnetic circuit breakers, a class of protector in which the breaking of the circuit is a function of current only. We do place in proper perspective the value of, and need for, other devices like fuses and thermal breakers, which, when correctly utilized, serve useful functions.

However, our major emphasis is on magnetic breakers, the electromagnetic circuit protectors which lend themselves to a great variety of ingenious devices. Like fuses, they will respond to short circuits caused by faulty wiring to keep a house from burning down; but this is an unlikely spot for their application. You’re most likely to find magnetic circuit breakers protecting computers, micro-processors and other solid-state systems, remote controls, industrial automation and air-conditioning, variable speed drives and a myriad of other industrial equipment and systems.



SENSATA’S PHILOSOPHY OF PROTECTION

Reliable circuit protection is automatic protection which limits a fault to a single circuit. More importantly, it minimizes the danger of smoke and fire, not only in the equipment, but also in the conductors (or cables) leading to and from the equipment. Besides protecting the conductors, the protector must isolate the fault from the power source so that non-faulted circuits can continue functioning in a normal manner. These objectives may not always be achieved by a single protective device. To accomplish optimum protection, circuit designers must use the correct combination of devices, correct sizing of wire and safe routing to contribute to the overall circuit protection philosophy.

The choice between circuit breakers, fuses, limiters or other protection means is governed by specifications, customer preference, maintenance, space, environmental restraints and circuit requirements. Proper selection procedures must result in a protective device with the lowest rating that will not open inadvertently. It must sense the fault, then disconnect the faulted line from the power distribution system before the wire insulation is destroyed. In addition, circuit breakers should almost always be trip-free, meaning that they cannot be held on against an overload. There are clear exceptions, such as in aircraft, when under certain conditions operation must be maintained in spite of overload. Besides

AVAILABLE CHOICES OF PROTECTION

Typically, four principal options are available to the electrical engineer specifying protection devices. Fuses, still the most used device, operate by melting a shaped metal link. There are many types of ingenious thermal mechanical circuit breaker devices where a piece of metal is warped by heating to trigger a release mechanism. Also available are electronic breakers.

EXAMPLE: Devices with silicon controlled rectifiers in their output, which will open on the next zero crossover on alternating current, and magnetic circuit breakers whose trip point is a function of current only.

The engineer uses the protective devices to protect either his equipment or perhaps the power company from catastrophe, or human life – sometimes all three. The Underwriters’ Laboratories acknowledge two classes of protection: “Listed” branch circuit breakers and “Recognized” appliance circuit protectors. Branch circuit breakers protect wiring and/or the equipment. They may have a lower rating than the breaker in a machine, thus protecting both wiring and the machine. Appliance protectors protect equipment. The reference “appliance” may be misconstrued; here the term appliance

considering all the variables involved, the time-current characteristics of the protective device should be compared with the time-current characteristics of the equipment (including starting or overload surges) component or wire.

The entire electrical system, including the power source, wire (single or bundles), switching devices and equipment must be protected from faults. Generally, a circuit protector is used at any point in a circuit where the conductor size is reduced, unless the immediate upstream protector provides adequate protection for the smaller wire.

Circuit components, such as transformers, rectifiers, filters, regulators and electronic circuits, have significantly different overload withstand characteristics from those of wire and cable. Many electronic circuits and components require extremely fast clearing devices, such as very fast acting fuses, to provide adequate protection from thermal damage.

extends to cover industrial equipment and control units such as computers, terminals, computer peripheral devices, key punches, printers and data processors.

“Ground fault” protection, as later described, is not yet required for all home circuits in the United States because of the partial protection provided by our three-wire electric system. Ground fault interrupters are used extensively in Europe, however, where the usual installation is 230 volts and where the third-wire ground is not commonly carried out to appliances. A sufficiently sensitive ground fault system can detect the presence of current to ground, such as from the hot wire through a human body to ground, and interrupt the circuit before the electric shock becomes fatal.

FUSES

Fuses, usually metal links of a lead alloy, are used extensively in the U.S., and work fairly well considering their intrinsic problems. Being dependent on the melting of a metal link, their exact blow point is subject to considerable variation. In addition, they must also be replaced, depending as they do on self-destruction.

When a fuse operates, the current of melting and the current of circuit interruption may vary greatly. Fuse-clip size and condition, and the size of the conductor attached to it can have a considerable influence on fuse performance. (Figure 1 shows effect of ambient temperature on fuse performance.) In addition, corrosion of fuse and connecting clip causes fuse heating problems.

Silver-link semiconductor fuses are fast-blow devices designed to protect SCR's and power diodes from the damaging effects of heavy short circuits, reversed polarity and the like. When semiconductors are subjected to very high current overloads, thermal damage occurs which is proportional to I^2T . As a result, fast blow silver-link fuses have been developed where performance characteristics are similarly I^2T dependent. Proper matching of fuse to semiconductor results in very effective protection.

The deterioration of semiconductors from overload is progressive, i.e., successive overloads reduce the maximum inverse voltage obtainable and may contribute to eventual device failure. The problem is accentuated by the fact that a rectifier does not turn on instantly across the device; the conducting path spreads through the semiconductor in an appreciable time interval.

The high-speed action of "current limiting" semiconductor fuses (Figure 2) comes from a silver link with a small link section joining a substantial size sheet of silver. Silver provides a maximum of thermal conductivity, and short-circuit protection is provided when the rate of rise of heat in the small link exceeds the rate of thermal conduction away from the link. As the link melts, the voltage across it rises and arcing begins. Arc quenching is aided by silica sand crystals which effectively lengthen the arc path (Figure 3).

During fuse action, there are three time-stages designated as melting time, arcing time and clearing time (Figure 4). Clearing time and peak let-through current are of greatest interest to the circuit engineer.

The voltage rating of a semiconductor fuse is important. Sometimes a user may apply 250-volt fuses to 125-volt circuits, thinking he has achieved greater safety. This is not quite true – voltage ratings should not be interchanged because a high voltage rating may provide a less desirable I^2T rating, and possibly cause excessive voltage transients by clearing the circuit too quickly.

In some cases, fuses offer an adequate low-cost method of protection. However, because of the replaceable nature of fuses and the ease of overfusing, protection may not be adequate. Within certain maximum and minimum ratings, fuse dimensions are usually the same; and it is possible to substitute a 20 ampere fuse where a 5 or 10 ampere fuse should be. Often when a correct value replacement is not available (or the fuse blows too often), a higher rating is substituted.

A less known but still troublesome characteristic is fuse element deterioration, caused by chemical and physical stresses produced in the fuse element during repeated short duration overloads. For example, motor starting produces a short current inrush followed by low running current conditions. The inrush current, usually higher than the fuse rating, is not present long enough to blow a correctly applied fuse. However, deterioration of the element, resulting from repeated motor starting, often causes mysterious fuse failures.

MECHANICAL BREAKERS

Mechanical breakers, both thermal and magnetic, require an appreciable time to operate. Magnetic types are by far the fastest of the two. Under dead short circuit, the operating speed of its mechanical mechanism will be as low as three or four milliseconds. This may not be fast enough for certain kinds of diodes and silicon-controlled rectifiers because their heat sinks are not effective for short duration, high amplitude overloads. The time-to-trip of a typical Airpax breaker is illustrated in Figure 5, up to 10 times rated current (1,000 percent). The band appearing on the curve means that the trip time will not fall below the lower line of the band, and will trip somewhere inside the band.

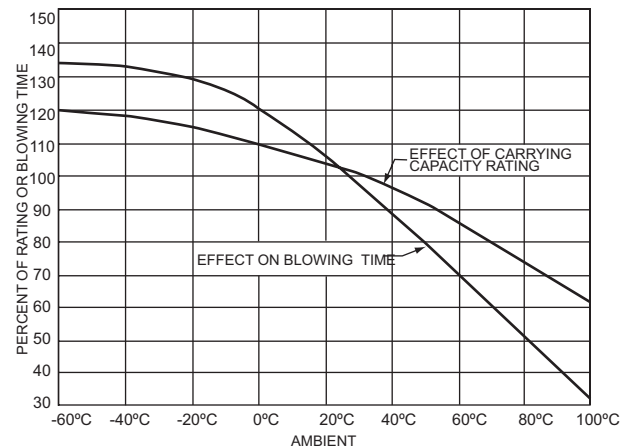

Fig. 1 Ambient temperature versus operating characteristics of fuses.



Fig. 2 Silver link semiconductor fuse.

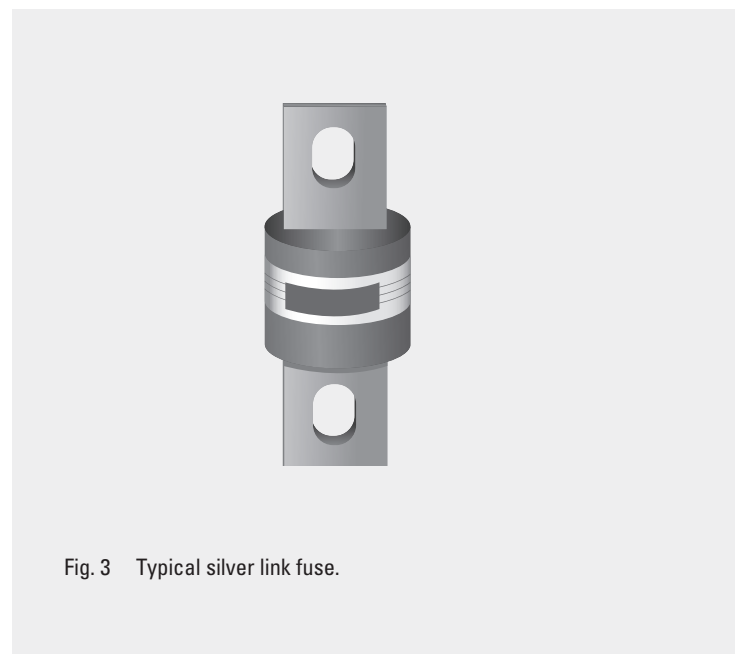

Fig. 3 Typical silver link fuse.

Thermal Circuit Breakers

Thermal circuit breakers function to protect the power wiring, and the power grid behind it, from the mistakes of the power user. As such, they do a good job. A high quality thermal circuit breaker, from sources such as Sensata Technologies and others, will open a 10,000 ampere fault at 250 volts AC in about 40 or 50 milliseconds. It probably will even do this more than once. In contrast, a magnetic breaker will open a similar fault in about 10 milliseconds, and also probably more than once.

Thermal circuit breakers are dependent upon temperature rise in the sensing element for actuation. In normal operation, deflection of a thermal sensing element (e.g. bimetal) will cause the circuit to open when a pre-determined calibration temperature is reached. Temperature rise in the sensing element is caused principally from load current I²R heating. The thermal element also integrates heating or cooling effects from external sources, and tends to derate or uprate from room temperature calibration with corresponding fluctuations in ambient temperatures.

The size of the thermal element, its configuration, and its physical shape and electrical resistivity determine the current capacity of the circuit breaker. In some cases, a heater coil is placed adjacent to, and electrically in series with, the thermal element to augment self-heating of the thermal trip element. This is especially true in ratings below five amperes.

The most common thermal element used is a "sandwich" of two or three different metals. The low expansion side may be invar (a nickel steel alloy), the center may be copper for low resistivity or nickel for high resistivity. Metals used in the high expansion side vary considerably.

In order to protect wiring, upstream components and the breaker itself from unnecessarily long thermal and mechanical stress during high fault level currents, an electromagnet is sometimes added to cause faster tripping of the thermal breaker. This magnetic circuit usually consists of a few turns of a large cross-section conductor in series with the thermal element and has negligible effect on the total breaker impedance. The magnetic assist usually has a crossover point well above the normal overload calibration range. There is little effect on the normal thermal trip response time, but with high overload conditions the current level generates sufficient magnetic force to trip the breaker magnetically without waiting for the bimetal to de-flect. This construction results in very fast trip times on high overloads.

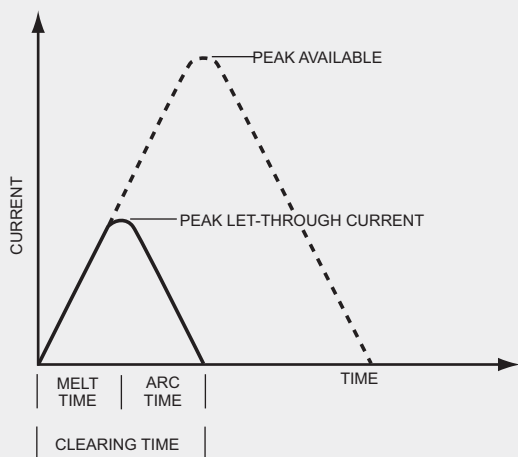

Fig. 4 Silver link fuse characteristics

A simple thermal circuit breaker's trip point is affected by variations in ambient temperature. A temperature (ambient) compensated circuit breaker is a breaker in which a thermal responsive element is introduced to compensate for changes in external temperatures. The compensating element usually is electrically isolated from and is independent of the current carrying thermal trip element, and acts only when a change in ambient temperature occurs. The degree of compensation may vary from partial to full compensation. A fully compensated breaker will operate nearly independently of its ambient temperature within a limited temperature range.

A hot-wire thermal circuit breaker uses the expansion of a high temperature wire as a means to cause the contacts to open. Because the temperature of the wire at time of trip is in the order of 800-900°F, changes in ambient temperature have little effect upon the calibration. Its trip time is faster than the bimetal breaker, but its voltage drop is higher.

Figure 6 shows the outline of a typical, good quality thermal breaker used in wiring applications and arranged to plug into a distribution panel.

Thermal circuit breakers are best suited to protect wire since the thermal element within the breaker tracks the performance of the protected wire. This can be observed by comparing Figure 7 (a) and (b) which shows thermal circuit breaker characteristics and time current limits for copper wire.

The problem of selecting the correct thermal breaker is more complex than simply matching the breaker rating with the wire rating. One must also consider the ambient operating temperature (see Figure 8), the allowable voltage drop and the heat sinking provided. Low cost thermal breakers using simple bimetallic elements only, are limited to applications such as wiring protection in low voltage circuits like those in automobiles.

Thermal breakers are necessarily temperature sensitive, although clever design permits some compensation against ambient change. Many people are familiar with nuisance tripping of the power-panel breakers on a hot summer day. The reasons become quite evident from Figure 8 which compares the relative performance of an Airpax magnetic breaker with a comparable thermal type of about the same rating. As shown, at 85°C this thermal breaker would trip at about 60 percent of its rated continuous current, while at 40°C this increases to about 200 percent of rating.

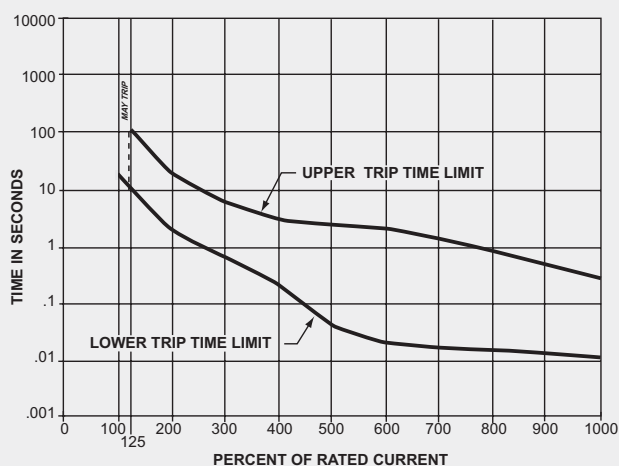

Fig. 5 Trip time characteristics of a typical Airpax magnetic breaker.

MAGNETIC CIRCUIT BREAKERS

A magnetic circuit breaker, sealed or nonsealed, provides manual switching, opens automatically under overload conditions and carries full-rated current. Sealed circuit breakers, which have an advantage in that they are less affected by adverse environments, typically are made only in ratings below 20 amperes. Nonsealed circuit breakers provide for higher power requirements, but most are restricted as to environment.

The magnetic time-delay circuit breaker operates on the solenoid principle where a movable core held with a spring, in a tube, and damped with a fluid, may be moved by the magnetic field of a series coil (Figure 9). As the core moves toward a pole piece, the reluctance of the magnetic circuit containing the armature is reduced. The armature is then attracted, causing the mechanism to trip and open the contacts on an overload or fault condition.

The ultimate trip current – the minimum current that will provide a reliable trip of the breaker (115 percent is typical) – which is independent of ambient temperature, is dependent primarily on the number of ampere turns and the delay tube design. This trip point occurs after a predetermined time when the core has made its full travel in the tube.

The instantaneous trip current is that value of current required to trip the circuit breaker without causing the core to move in the tube. This is possible because excess leakage flux in the magnetic circuit, caused by high overloads or faults, will attract the armature and trip the circuit breaker. Instantaneous trip point is also independent of the ambient temperature. The instantaneous trip current is usually on the order of ten times the current rating of the circuit breaker. Since fluid fill impedes core movement, an inverse overload time-delay results so that trip time is less as the percent of overload is increased.

“Instantaneous-trip” circuit breakers have no intentional time delay and are sensitive to current inrushes and vibration and shock. Consequently, they should be used with some discretion where these factors are known to exist.

Magnetic breakers are versatile and lend themselves to coordination with other forms of protection. In the circuit of Figure 10, three semiconductor fuses provide final protection against a catastrophic short circuit, such as is experienced from wiring errors on start-up of a complex system. The four pole magnetic breaker, which protects against less than absolute shorts, opens before the silver-link fuses blow on such overloads. In Figure 10, three of the poles protect the separate legs of a three-phase system, and the fourth leg sums the DC delivered to the system.

At high overloads, fuses and thermal breakers respond according to the function I^2T with resistance being assumed constant. Magnetic breakers operate as a function of current only, the coil turns being constant.

In time delayed magnetic breakers the oil viscosity changes with temperature. Accordingly, the time of response of a magnetic breaker decreases as temperature increases, a factor sometimes considered a virtue. The current of trip, however, remains essentially unchanged with change in temperature; herein lies one of the major virtues of magnetic circuit protectors. An Airpax protector will repeat the current of trip to about 2 percent. Not being dependent on heating elements, the magnetic protector will trip at values as low as 125 percent of the rated full-load value under all ambient temperature conditions. Thus at 200 percent load, a magnetic breaker can be designed to trip in 25 milliseconds or as long as 50 seconds. At 800 percent load, the thermal type would require about one second, a magnetic type about 15 milliseconds.

The effect of temperature on a magnetic breaker is illustrated in Figure 11. The current of trip remains unchanged; the nominal time of the trip of an Airpax protector, style APG, delay 62 at 125 percent load is 30 seconds at +25°C, 100 seconds at -40°C and 10 seconds at +85°C. The 200 percent trip is 6.0 seconds at +25°C, swinging from 15.0 seconds at -40°C to 2 seconds at

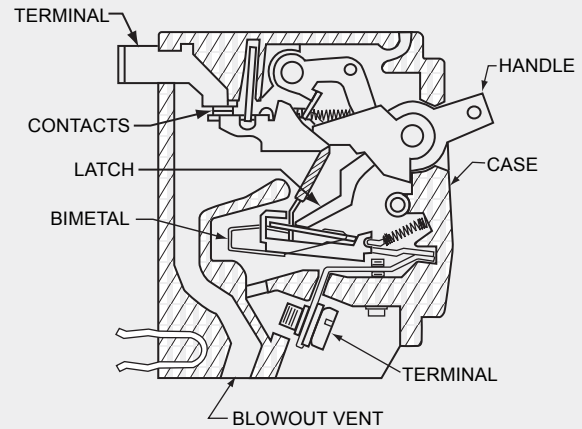

Fig. 6 Outline of a typical thermal breaker. Square D Type QO.

+85°C. The faster trip time at the higher temperatures, along with the constant trip current, sometimes is considered to be advantageous.

All trip times and 100 percent hold specifications, as shown on delay curves, assume that the circuit breaker is in a normal mount position as illustrated in Figure 12. With the delay mechanism situated on the horizontal plane, gravity has little or no effect on the core. Obviously, if the delay mechanism is mounted vertically or at any angle, gravity will have either an impeding or increasing effect on the movement of the delay core. If the unit is mounted with gravity impeding, it's likely that the breaker will not trip at the rated trip current. Its ultimate trip current will be beyond the range indicated in the delay specifications for the breaker. Conversely, if gravity is aiding, the ultimate trip current may be less than the 100 percent hold specified.

It is recommended that when other than horizontal mounting attitudes are required, the breaker supplier be contacted for specific delay recommendations. Normal mounting is defined as mounting on a vertical panel with “ON” up.

A magnetic breaker can be reset immediately after tripping, although the delay mechanism does not immediately reset. If the fault is still present, this will reduce the time to trip. This usually is not true with thermal breakers since the heating element must cool down before it will reset.

The magnetic breaker shown in Figure 12 is essentially a toggle switch composed of a handle connected to a contact bar which opens and closes an electrical circuit as the handle is moved to the “ON” or “OFF” position. The handle is connected to the contact bar by a link which is collapsible.

When this link collapses, it allows the contacts of the unit to fly open, thus breaking the electrical circuit. The magnetic circuit within the unit consists of the frame (1) armature (2) delay core (3) and pole piece (12). The electrical

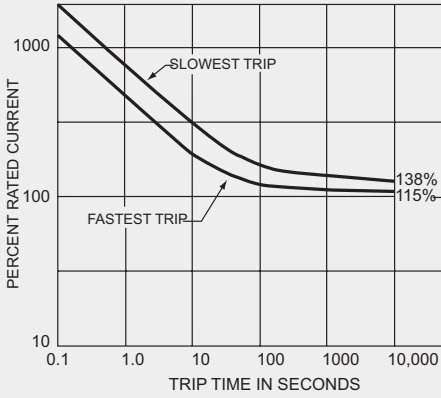
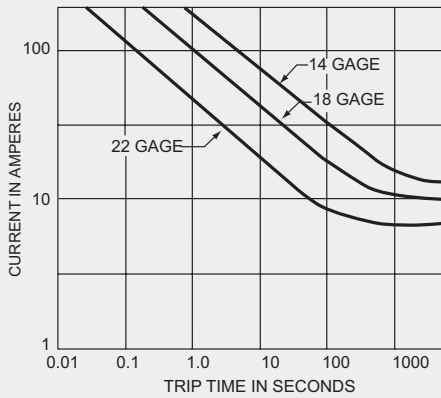

Fig.7 (a) Thermal breaker characteristics.



(b) Time current limits for copper wire.

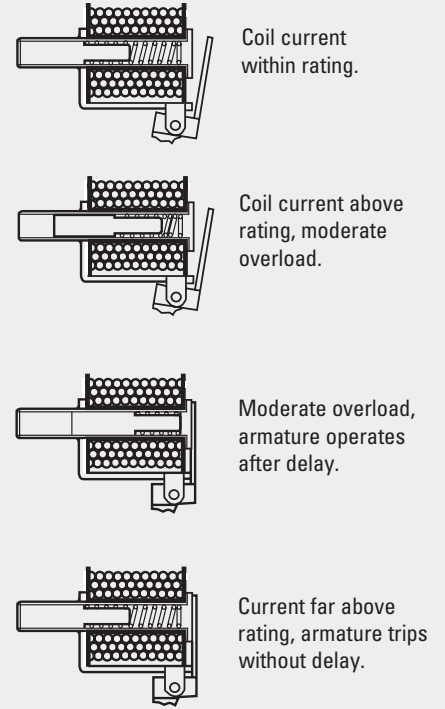

Fig. 9 Mechanical time delay used in Airpax magnetic breakers.

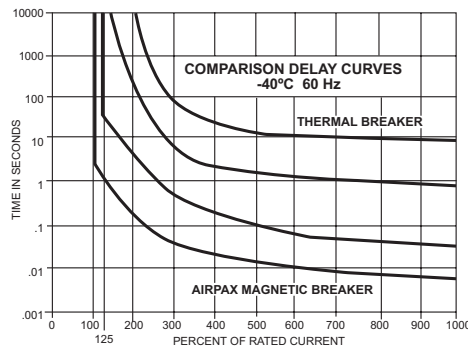
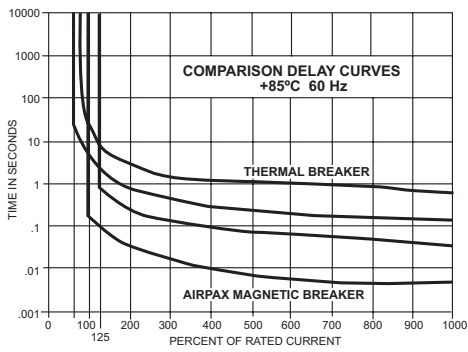

Fig. 8 Magnetic versus thermal breaker characteristics at high and low temperatures.

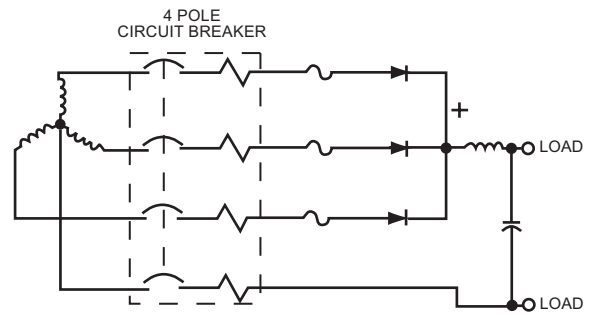

Fig. 10 Combination of AC overload, DC overload and semiconductor fuse protection.

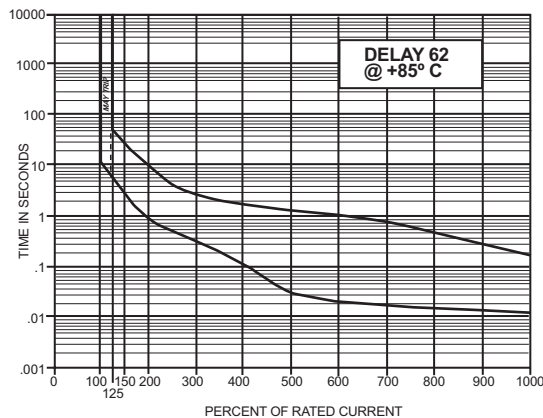
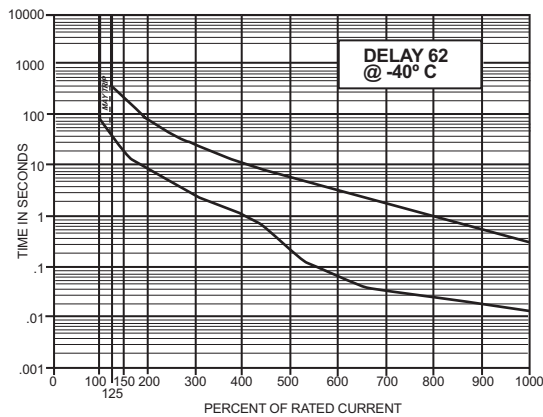
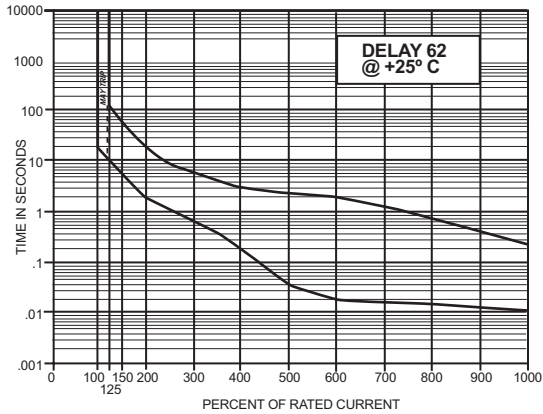

Fig. 11 Effect of temperature on a magnetic breaker trip time.

circuit consists of terminal (4) coil (5) contact bar (6) contact (7) contact (8) and terminal (9).

As long as the current flowing through the unit remains below 100 percent of the rated current of the unit, the mechanism will not trip and the contacts will remain closed as shown in Figure 12 (a). Under these conditions, the electrical circuit can be opened and closed by moving the toggle handle (10) on and off.

If the current is increased to a point between 100 percent and 125 percent of the rated current of the unit, the magnetic flux generated in coil (5) is sufficient to move the delay core (3) against spring (11) to a position where it comes to rest against pole piece (12) as shown in Figure 12 (b).

The movement of this core against the pole piece increases the flux in the magnetic circuit described above enough to cause the armature (2) to move from its normal position shown in Figure 12 (a) to the position shown in Figure 12 (b). As the armature moves it trips sear pin (13) which, in turn, triggers the collapsible link of the mechanism, thus opening the contacts.

The delay tube is filled with a silicone fluid which controls the speed at which the delay core moves, so different delay curves can be obtained by using fluids of different viscosities.

When high surges occur in an electrical circuit, the magnitude of the flux produced in the magnetic circuit should be sufficient to trip the unit without the delay core changing position. For protection of UL appliances such as those listed previously, protector delay curves that provide instant trip at surges of 600 percent or more should be applied.

By comparison, these same protectors would probably cause nuisance tripping if specified for applications such as induction motor starting. In this latter situation, delay curves may be selected that do not become instant until surges of 1200 to 1400 percent are experienced.

Magnetic circuit breakers typically have very low voltage drops at rated load. However, when operating at very low voltages, the drop may become a significant factor and should be taken into account if the load voltage is critical.

SHORT CIRCUIT CAPACITY

When applying any overload protection device, it is important to know that the available short circuit fault current at the device is not in excess of that which can safely be interrupted. Available short circuit current is the maximum RMS current which would flow if all active conductors were solidly bolted together at the point of fault protected by the device. In reality, actual fault current is much less than available fault current. The primary factors that determine the available fault current are supply transformer size, the impedance of the cable or wire and that of the connections. These factors, in addition to the fault resistance, determine the actual fault current.

For a three-phase transformer (rating details are usually available on the nameplate), the available fault current on the bus bars may be roughly calculated from the formula:

$$\text{Available Fault Current} = \frac{\text{Transformer Rating (VA)}}{\sqrt{3} \times \text{Rated Voltage} \times \text{Percent Impedance of Transformer (expressed as a decimal)}}$$

As a rule of thumb, the available fault current from a 60Hz transformer is usually about 20 times the full load current, while a 400Hz transformer can produce about 12.5 times the full load current.

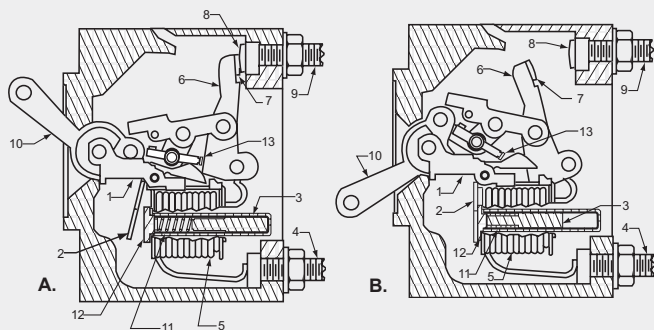

Fig. 12 Operating mechanism of an Airpax magnetic circuit breaker.

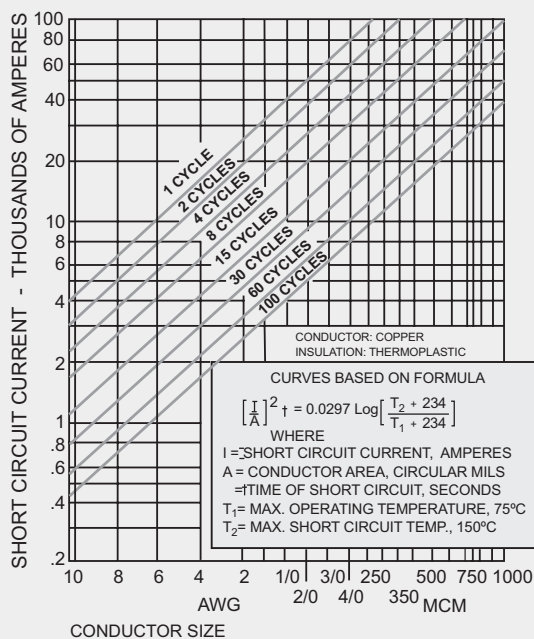

Fig. 13 Short circuit currents for insulated cables.

The percent impedance is basically a statement of the internal impedance of the transformer and is available on the nameplate or from the manufacturer. Percent impedance can be expressed as follows:

$$\% Z = \frac{I \text{ rated} \times \text{ohms} \times 100}{V \text{ rated}}$$

The percent impedance for 60Hz transformers is approximately four to seven percent for average size transformers.

Although a transformer can provide a severe limiting effect on fault current, wire and connector, resistance becomes very significant as distance increases. The resistance of a few yards of cable can reduce the fault current considerably.

The effective current capacity of a line can be computed roughly by a simple differential measurement, i.e., the output voltage difference of the line from no load to full load. For example, if a 120 volt line supplying 30 amperes has a 6 volt drop, the total impedance back to the original generator is $R = 6/30 = 0.2$ ohms and the short-circuit current is 600 amperes until something lets go.

Faults considered as "typical" are usually not destructive to the breaker. The majority of faults are faults-to-ground rather than line-to-line. With the difficulty normally encountered in obtaining a good direct ground, the actual fault current is unlikely to exceed 400 amperes. Obviously as a safety precaution, in the event of a heavy fault trip out, caution should be exercised before attempting to reset the circuit breaker. Corrective measures should be taken to assure that the fault has been cleared, or that the main power is removed from the system by positioning a separate disconnect.

Because of the increasing capacity of power systems, sometimes it is possible to have short-circuit current high enough to seriously damage conductor insulation. For a guide to prevent such damage, see Figure 13. It is based on a short-time temperature limit of 150°C for thermoplastic insulation. Paper, rubber and varnished cloth insulation has a slightly higher short-circuit capability based on a short-time 200°C temperature limit. (Source: Insulated Power Cable Engineers Association: 1 PCEA.)

BATTERY LET-THROUGH CURRENTS

The factors affecting DC short-circuit analysis are similar to those considered in AC. In the simplest terms, the theoretical available DC fault current from a battery can be calculated from the following:

$$\text{Available DC fault current} = \frac{\text{Battery voltage}}{\text{Battery internal resistance}}$$

Table 1, which provides values for let-through currents, was established using data from actual tests on a large number of standard batteries. All interrupt tests were run with Airpax APL family protectors. Note: the protectors provided successful interruption at 5200 amperes at 12 volts.

When batteries are wired in parallel, the effective battery internal resistance drops in accordance with parallel resistance laws. Conversely, when batteries are connected in series, the effective internal resistance increases.

TRANSIENT TRIPPING

The fast operating speeds of magnetic protectors can cause nuisance tripping on high amplitude transients. When a transient of sufficient energy content arrives, the protector responds in an instantaneous trip mode. This is permissible in applications where transients of this nature are likely to cause damage to circuit components.

For example (Figure 14), the resistance of a tungsten lamp is low when cold, but high when energized. A maximum pulse, about 4 milliseconds in duration, can occur when switch closure coincides with the peak voltage point of the supply and the load is one that has low initial impedance such as an incandescent lamp bank, a high capacitive load, or a ferroresonant transformer.

Nuisance trips will result if pulse energy exceeds the energy needed to trip the protector. The amplitude of tungsten lamp surges may be 15 times the rated steady state current at first – the following cycles are much lower. Here, protector inrush rating can be increased, but only at the expense of overload protection.

In another example (Figure 15), capacitive input filter charging resembles an RC charge curve. At peak current it's limited by charge circuit resistance and the power supply itself. Here, surges are less troublesome; transient duration is very short.

Further, in a typical AC to DC power supply, (Figure 16), measured steady-

state AC current is 0.265 amperes RMS and about 0.375 amperes peak. When the circuit protector is closed, the current in the filter circuit reaches 13 amperes. If a standard magnetic protector is used, the current would have to be de-rated to about 2 amperes to avoid nuisance tripping. A reasonable compromise is to use a pulse tolerant protector that permits a more reasonable rating of about 1 ampere.

Transformer inrush (Figure 17), is the most common application problem. Its waveform is similar to that of lamp-load inrush. However, unlike a lamp-load inrush, the transient will not occur on every turn-on. But, like the lamp load, it has a maximum peak value when the circuit is closed near the maximum voltage point of the supply wave.

To assure application of the correct breaker, the designer should perform a repeated turn-on, turn-off exercise. This will help verify that the breaker selected is one that will avoid nuisance tripping. Also, the exercise should be conducted with the highest line voltage that is anticipated in the circuit.

oriented, high-silicon steel cores have serious “very high inrush current at turn-on” problems. These currents can be as high as 30 times the normal rated current, compared with approximately 18 times for older transformers.

The “worst condition,” highest spikes for 60Hz primary, are of approximately 4 milli-second duration. This turn-on transient is concentrated in the first half cycle with successive half-cycles depreciating in amplitude very quickly. The transient is not very sensitive to transformer load; in fact, a loaded transformer may have slightly less severe transients than when under no load.

At the instant of turn-on, the inrush of transient varies with the residual magnetism of the core and with the relative phase of the primary voltage at turn-on. The worst case transient will not occur at each equipment turn-on, but more likely in 1 in 5 or 10 turn-ons.

Inrush transients are most severe when the power input is a low impedance source, and the line voltage is high. The maximum spike may be as much as 20 to 25 percent higher at 130 volts than at 120 volts with the same circuit.

Pulse tolerant protectors must accept the first surge of current without tripping, while still providing maximum equipment protection. This is accomplished either by shunting high flux peaks away from the armature or using an inertial device to damp the armature from short duration pulses. Each method requires a compromise. Shunts distort the trip time curve in the area of 600 to 1200 percent overload, which may make trip time unacceptable. Dampers (inertia wheels) are effective only in the area of the first half-cycle of high overload currents. If the high current persists past the first cycle, the inertia wheel will tend to aid trip out to provide the necessary protection.

| Some typical let-through currents on various battery configurations subjected to near short circuit conditions. | | | |
|---|----------------|--------------------------------------|----------------------------------|
| Battery Configurations | Battery Temp F | Circuit Configurations (1) | Average Let-Through Current Amps |
| (2) 3-205 AH(ea.) 12V in parallel | 65 | 8ft. 4.0 cable | 3700 |
| (3) 3-205 AH(ea.) 12V in parallel | 65 | 8ft. 4.0 cable | 5200(4) |
| (3) 1-205 AH 12V | 63 | 7ft. 4.0 cable | 2800 |
| (3) 4-240AH(ea.) 8V in series | 65 | 7ft. 4.0 cable and 4ft. 1.0 cable | 2600 |
| (3) 1-70 AH 12V | 65 | 8ft. 4.0 cable | 1400 |

In all cases, the batteries were fully charged and had been left on trickle charge until time of the test. The series circuit breakers interrupted these loads in 7 msec to 11 msec. Neither the batteries nor the breaker suffered any apparent damage. This data was collected in cooperation with the AMF Hatteras Engineering staff at High Point, N.C.

Notes: (1) Heavy duty contractor, 200A shunt and 50 Amp magnetic circuit breaker were also in the circuit.
 (2) Batteries about 1 year old and heavily used.
 (3) New batteries cycled once to 50% charge and recharged.
 (4) With 350A Aircraft type fuse replacing the circuit breaker the let-through current was 6400A.

Table 1

This type of short-time transients may be handled by Airpax inertial delay type 62F, Figure 18, a pulse tolerant design which uses inertial integration of short time pulses. The integrator has an effect only on the armature and does not control the longer time delays to any appreciable extent. Figure 19 illustrates the mechanical device used to provide armature delay. However, the time of circuit interruption (by opening contacts) is set effectively by the time to reach zero on the AC cycle (when the source voltage reaches over 50 volts). The “inertia” wheel protector, which is designed for short-duration, high-amplitude pulses, 20 to 30 times rated current for about 4 to 5 milli-seconds, has no particular effect for long-duration, lower-amplitude overloads (such as experienced during motor starting).

Currently, design trends demand a reduction in size and weight of system components, particularly transformers. Newer transformers having grain-

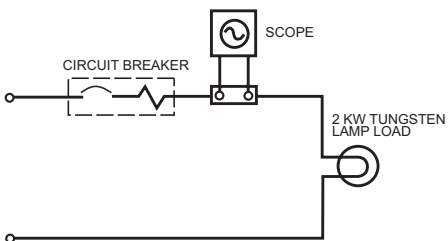
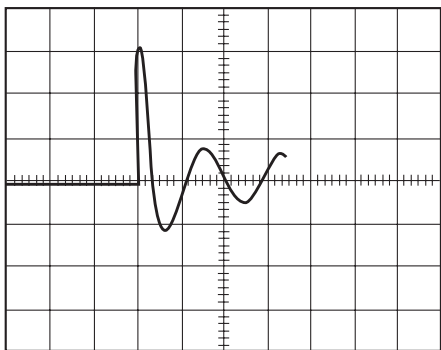

Fig 14 Transient current from a tungsten lamp load.

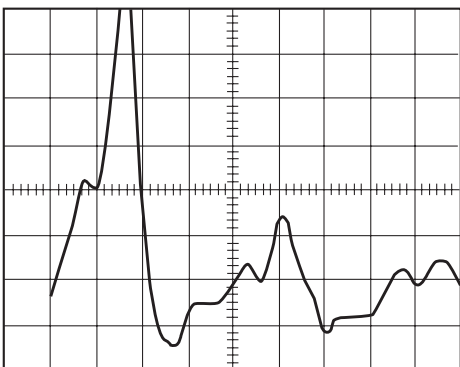

Fig. 15 Transient from capacitive filter.

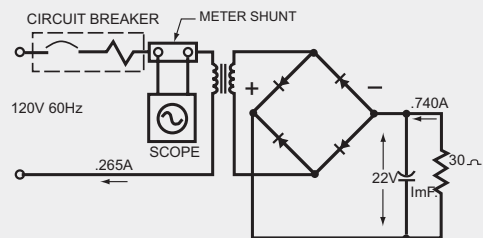

Fig. 16 Typical capacitive filter circuit.

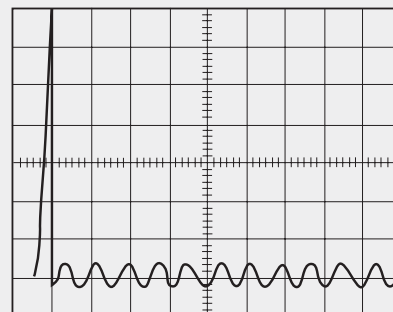

Fig. 17 Transformer starting transient.

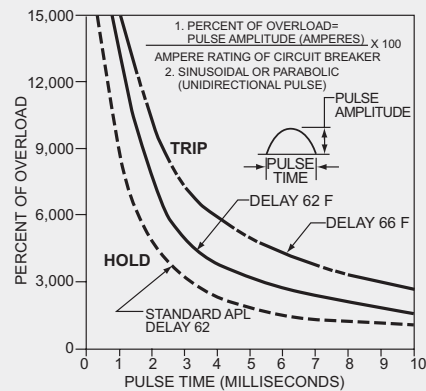

Fig. 18 Percent of overload versus pulse time of an Airpax magnetic breaker.

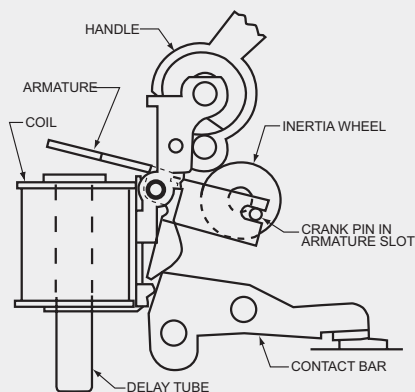

Fig. 19 Inertial integration against nuisance tripping.

Table 2
Motorstart

| | (1) | (2) | (3) | (4) | (5) | (6) |
|-----------------------------|------------------------------|---------------------------------|-------------------------|--------------|--------------|-----|
| Motor Type | Start Current Peak Ampl. RMS | Duration of Start Surge in Sec. | Load Second %1 x t Sec. | APL Delay 62 | APL Delay 66 | |
| Shaded Pole | 150% | 2.0 sec. | .3 | ok | ok | |
| Series AC-DC | 530% | .100 | .5 | no | ok | |
| Series AC-DC | 200% | .400 | .8 | ok | ok | |
| Series AC-DC | 333% | .167 | .5 | ok | ok | |
| Split Phase | 600% | .116 | .7 | no | ok | |
| Split Phase | 425% | .500 | 2.0 | no | ok | |
| Capacitor Load | 400% | .600 | 2.4 | no | ok | |
| Capacitor No Load | 300% | .100 | .3 | ok | ok | |
| Capacitor Load | 420% | .500 | 2.1 | no | no | |
| Induction | 700% | .750 | 5.0 | no | no | |
| 3 Phase | 350% | .167 | .6 | ok | ok | |
| Cap. Start. Split Phase Run | 290% | .083 | .24 | ok | ok | |

MEASURING INRUSH CURRENTS

Precise measurement of inrush current is needed to tailor delays for protection against nuisance tripping. Current meters and chart recorders respond too slowly to measure the problems: therefore, an oscilloscope must be used. Caution: oscilloscope current probes will saturate and distort wave forms above a value 12 to 14 times the rated currents, giving the impression of a much lesser value than actual. It would be better to insert a current meter shunt in the primary circuit and then sense voltage drop across the shunt with a calibrated scope. This would provide a visual readout of time duration amplitude and wave-shape of the turn on currents. Another technique uses a resistor of known value of less than 0.10 ohms and of sufficient wattage for the anticipated load.

Figure 20 shows a circuit employed to evaluate inrush currents typical of auto-transformers. Measured steady-state AC current in the primary portion of this circuit is 10 amperes RMS, or 14.1 amperes peak.

When it's used to evaluate the circuit in Figure 20, the current in the test circuit reaches 180 amperes. For the best steady-state protection without

nuisance tripping, a pulse-tolerant protector rated at 10 amperes is recommended.

One final word on transient tripping. The primary function of newer delays is to improve transient tripping characteristics. In the applications mentioned previously, along with many others, the potential of uninterrupted on-line operation will be enhanced by precisely defining the pulse train anticipated and then tailoring delays for the need.

MOTOR PROTECTION

The starting energy requirements of AC motors are spread over seconds rather than milliseconds, and vary considerably with the type of load and with the inertia of the load. However, the peak amplitude of the starting current is generally within reasonable values.

Table 2 provides some typical figures as observed on motors selected at random. Note that single-phase induction motors are the worst, usually having a starting winding which can draw 7 or 8 times the running current

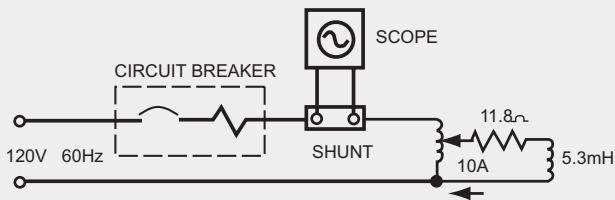

Fig. 20 Circuit to evaluate transformer transients

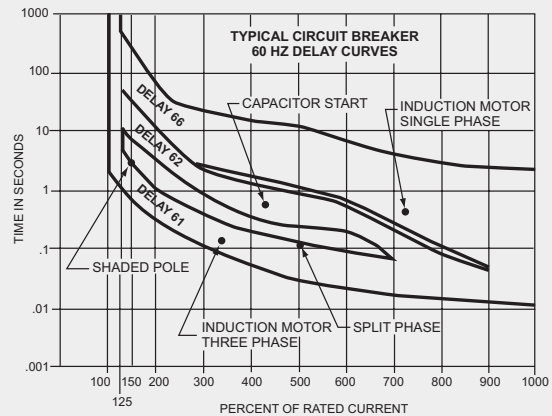

Fig. 21 Time position of various motors on start.

for the best part of a second. A 750-millisecond surge duration was observed on several of the various horsepower ratings.

Most magnetic breakers exhibit a reasonably flat frequency response – trip point versus frequency – in applications between 20 and 200Hz. Beyond 200Hz, up to 440Hz, special design considerations are required. Beyond 440Hz, the breaker supplier must be consulted.

Induction motors usually are protected by a thermal device imbedded inside the motor. Most protectors which will handle the starting surge will not trip out soon enough on lesser overloads to prevent damage to the motor. Here you are protecting the power wiring rather than the device. Magnetic protectors are available which offer a better compromise. Figure 21 shows three delays for several different motors. The marginal position of single-phase induction motors is obvious.

SCR MOTOR DRIVES

Typically, SCR motor drives exhibit non-sinusoidal load currents and necessitate derating of the protector.

Let's look at an example. With a full wave rectified unfiltered load, the load may be 10 amps as read on an average responding meter. Using an RMS responsive meter, the actual RMS current reading for this load is 11.1 amps. The inclusion of an SCR device introduces a firing angle which will further increase the form factor. The form factor is actually the ratio of the RMS current to the average current. This ratio could be as high as 2 or 3; that is, the RMS current may be 2 or 3 times the value of the average current. In a typical circuit, a 20 amp protector may be tripping, even though measurement indicates lower than 20 amps exists. Battery chargers create a particularly severe problem because they exhibit a very high, spiked form factor. Again, both manufacturers of the batteries and breakers should be contacted.

Generally speaking, protectors for these applications would be an AC type even though they are being used for pulsed DC application. Therefore, before specifying a protector for pulsed SCR motor drives, it's usually necessary to consult the supplier to establish the details of the protector, its delay, rating, etc. As a starting point, consider the actual current rating of the protector to be the reading obtained on an RMS meter.

To say the protector is RMS responsive, is only an approximate statement. The degree to which it is truly RMS probably varies somewhat with the actual form factor. For very high form factors, you may need additional

correction. In this case, describe the applications to the supplier and allow him to select and tailor the protector to the application.

MAGNETIC CIRCUIT BREAKERS FOR SWITCHING POWER SUPPLIES

Protecting any equipment obviously requires an understanding of what you are protecting. Switching power supplies (commonly called switchers) have different characteristics than the familiar linear types.

When compared with linear type power supplies, switchers are smaller, lighter, and more efficient. They can tolerate a much greater range of input voltage and frequency than the linear types. On the other hand, switchers do not have as fast a recovery time, have slightly higher ripple content and a little less regulation factor than linears. Switchers also require a minimum load current of 20 to 25 percent for proper operation, whereas, the linear supplies are designed to operate from no load to full load.

The peak value of current at turn-on of linear supplies is in the range of 10 to 20 times RMS rated load values depending on the type of input transformer used. Switchers, almost without exception, do not use an input transformer but rectify the source power directly (see Illustration I). This can produce a peak turn on current as much as 40 to 100 times the rated RMS value of current. (See Illustration II.)

For this reason most switchers include some circuitry in series with the input line to limit this high peak value of current. Most of the smaller units up to 350 watts use a thermistor for this purpose. The thermistor has an initial cold resistance that is high, which quickly decreases to a very low resistance when hot. This limits the cold turn on peak current quite adequately, however, if the circuit is turned off and turned back on while the thermistor is in its low resistance condition the limiting characteristic is much less and can allow a high peak current that may cause nuisance tripping if the circuit protector is rated too low.

Larger wattage supplies use a resistor paralleled with a triac or some other "soft start" means to limit the high initial inrush current to the order of 20 times the rated RMS value of the supply. Though this inrush is quite high it is of short duration, usually from 3 to 5 cycles of 60Hz or 50 to 80 milliseconds and in a decaying amplitude. This high value of current is destructive to on-off switches that do not have contacts designed to resist these stresses.

The steady state input current of switchers is a train of pulses instead of a sinusoidal wave. These pulses are two to four milliseconds duration each

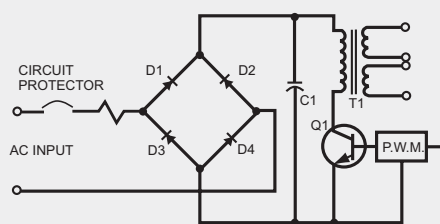

Illustration I

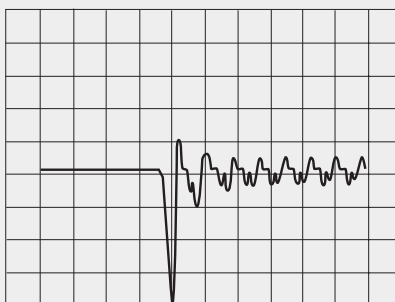

Illustration II

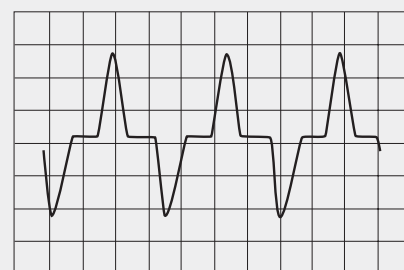

Illustration III

when on 60Hz power, with peak values two to three times the RMS value of the input current. (See Illustration III). This high peak pulse train has a tendency to advance the delay tube core of magnetic circuit protectors and can cause a buzzing sound or nuisance tripping if the current rating of the protector chosen is too near the rated input current of the power supply.

One of the features of most switchers is the inclusion of fold-back circuitry that shuts off or limits the pulse width modulator in the event of an overload in an output circuit. This feature protects against overloads on the output and leaves the circuit protector to afford protection for the input circuitry. The probable fault areas of the input circuitry are:

Number 1

Shorting of one or more of the diodes in the bridge.

Number 2

Shorting of the input capacitor.

Number 3

Shorting of the power switching transistor.

Number 4

Shorting of a winding in the transformer.

Any of these will cause an overcurrent much higher than the rated load current of the supply. By choosing a protector 2 to 3 times the rated input current with a high pulse tolerance delay you have eliminated the possibility of nuisance tripping, protected against potential faults and provided an on/off switch with suitable contacts, all in one component.

If the circuit protector has a load in addition to the switcher, the total load current and its waveform must be taken into consideration in sizing of the protector.

Since the inrush currents of switchers are typically 50 to 80 ms in duration and in a decaying pattern, the switcher can best be protected with a fast delay with high pulse tolerance such as the Airpax 61F or 64F. If you select a protector of less than 2 times the rated load you may encounter a buzzing or nuisance tripping from the protector. If the switcher has a soft start feature, the delay choice should be 61F. If there is no soft start feature, the 64F is recommended for its higher pulse tolerance to avoid the nuisance tripping of the inrush spike. One exception to this choice is when the input power is a 400Hz source. In this case, the delay used should be 41F to give better tripping characteristics.

If the appliance or equipment is to be used internationally, your choice of Airpax circuit protector should be from the SNAPAK, IEG, IEL or 209 families to provide the 8mm spacing requirements. Also many countries require both sides of the input lines to be switched in some applications, so a two pole unit may be required.

In summary, to determine the protector for a switching power supply application, choose from the Airpax circuit protector families with a 61F or 64F delay, 41F if for 400Hz, and a current rating two to three times the switcher rating.

ENVIRONMENTAL CONDITIONS

Obviously, operational environment must be evaluated along with electrical considerations. Heat, high vibration and shock conditions can cause nuisance tripping or even damage protective devices. For example, a fuse element is more fragile when hot than when it is cold. Also, improper mounting of a circuit protector can cause amplification of vibration through resonances of the basic vibration frequency and amplitude. Correctly designed magnetic breakers are those which incorporate balanced armatures that help minimize the effects of shock and vibration.



Fig. 22 Airpax™ AP circuit protector.



Fig. 23 Airpax™ APGN panel seal circuit protector.

Applications where circuit protectors are exposed to high humidity or corrosive atmosphere require environmental protection for the protector. Here, extensive use of corrosion resistant plating and stainless steel components is necessary to insure proper mechanical operation of unsealed protectors. If the protector must function under extreme conditions, a sealed protector (Figure 22) will insure reliable operation. In applications where a panel is exposed and the equipment is sealed, a panel seal protector (Figure 23) may be used as a compromise.

Probably the most difficult environment to tolerate is one that includes sand and dust. Over a period of time, the mechanism of most unsealed protectors will collect enough "grit" to impede operation. Every precaution should be taken to seal the installation, and to check protector functioning, procedures should be established to mechanically operate the protector on a regular basis. Whenever possible, dust sealed protectors should be specified.

When explosive atmospheres are anticipated, special system design is necessary to insure that open flame or sparks from electrical sources are not possible. This often requires hard conduit, sealed protectors and switch panel boxes. Some protectors have successfully passed the ignition test designed to simulate use in a gasoline vapor situation.

WHAT'S AVAILABLE IN PROTECTORS

It probably would be helpful to review the many protector variations available. The following highlights provide basic application data.

TIME DELAYS MATCH PROTECTION TO NEED

Trip delays must be long enough to avoid nuisance tripping caused by harmless transients, yet fast enough to open the circuit when a hazard exists. Continuing development of new delay configurations that exactly match the protector's performance to the specific needs is crucial to the life cycle economics of equipment.

Basically, four categories of trip delays are available:

Instantaneous

Usually under 100 ms, with most at approximately 15 ms – for very sensitive circuits where low overloads of short duration may be harmful, or where specific high currents definitely should not pass.

Fast Delay

Trips in less than 10 seconds – for circuits and electronic applications where temporary overloads of 200 percent cannot be tolerated for more than a few seconds.

Slow Delay

Trips in 10 to 100 seconds – for most large transformer-coupled loads where brief overloads can be tolerated without damage. Slow delays allow turn-on surges to pass without tripping.

Very Slow Delay

Trips in more than 100 seconds – for protection of wiring where a limited overload will usually not cause damage. For example, some motors have starting current surges lasting for seconds and drawing 600 percent or more of their running current rating. Protectors with very slow delays are the answer for these applications.

As overloads increase, time delays decay, to the point where the protector's mechanical inertial and arc quenching capability alone determine the circuit interrupting speed. At very high fault currents, the practical limit for magnetic protectors varies about 4 to 10 ms. They operate in the instantaneous mode when overload is increased beyond 10 times the rated load, for most breakers, and from 12 to 14 for other delays.

Newer delays have an inrush capability about the equivalent of a current flywheel. These delays, with the flywheel added, will up inrush withstanding capability even more, as much as 60 percent more.

Further, with the newer delays, up to 400 percent overload, the trip times actually are shorter than with conventional delays. Above 400 percent, the trip times are longer. For a motor starting load, for example, this provides more protection and better resistance to nuisance tripping at turn-on. Additional obvious applications for the newer delays include power supplies that have very large capacitance filters and with ferro-resonant power supplies used in the computer industry that need more protection – sometimes 30 times the normal inrush is possible.

MAGNETIC TIME DELAYS

The six magnetic time-delays shown in Figure 25 cover a variety of load and overload conditions. Delay 60 represents only the delay of the armature. Delay 61 is a quick-acting general purpose time delay for general use on electronic instruments. Both 60 and 61 are particularly useful in low voltage applications. Delay 62 is long enough to start several types of motors and is useful for most transformer, capacitor and tungsten lamp inrush currents. Delay 66 has a long delay especially for motors, as previously illustrated.

TRIP SWITCHING CONFIGURATIONS

The most popular configuration for magnetic protectors is the series trip where the sensing coil and contacts are in series with the load being protected. The handle position conveniently indicates circuit status. In addition to providing conventional overcurrent protection it's simultaneously used as an on-off switch.

Some other configurations, (Figure 26), include:

Shunt Trip

Designed for controlling two separate loads with one assembly. The control is established by providing overload protection for the critical load. When the current through this load becomes excessive and reaches the trip point, the protector will open and remove power from both loads simultaneously. The total current rating of both loads must not exceed the maximum contact rating.

Relay Trip

This permits the overload sensing coil to be placed in a circuit which is electrically isolated from the trip contacts. The coil may be actuated by sensors monitoring pressure, flow, temperature, speed, etc.; other typical applications include crowbar, interlock and emergency/rapid shutdown circuitry. Trip may be accomplished by voltage or current, which must be removed after trip.

Auxiliary Switch

This is furnished as an integral part of a series pole in single or multi-pole assemblies. Isolated electrically from the protector's circuit, the switch works in unison with the power contacts and provides indication at a remote location of the protector's on-off status.

Voltage Trip

Sometimes called "dump circuits" or "panic trip circuits," these units make it possible to open main power contacts with lower power inputs from one or more sources. This configuration is becoming increasingly more important for sensitive circuitry and denser packaging in automation systems.

Dual Function/Single Pole

Providing for both a voltage trip and a current trip function in a magnetic circuit protector is common practice. As illustrated in Figure 27, these two coil protectors provide remote or automatic opening of one or more circuits with a low level signal.

It is also possible to have both the instantaneous voltage trip coil and the overcurrent coil in a single pole. To provide the dual function, the obvious size and cost-savings over multi-pole configurations are substantial. Referring to Figure 28,

since the voltage and current coils share the same magnetic path, a current in either coil will actuate the armature and trip the protector. The voltage coil will trip the protector instantaneously while the current coil provides normal inverse time delays. The voltage coil is not rated for continuous duty and, therefore, the voltage must be removed when the breaker trips.

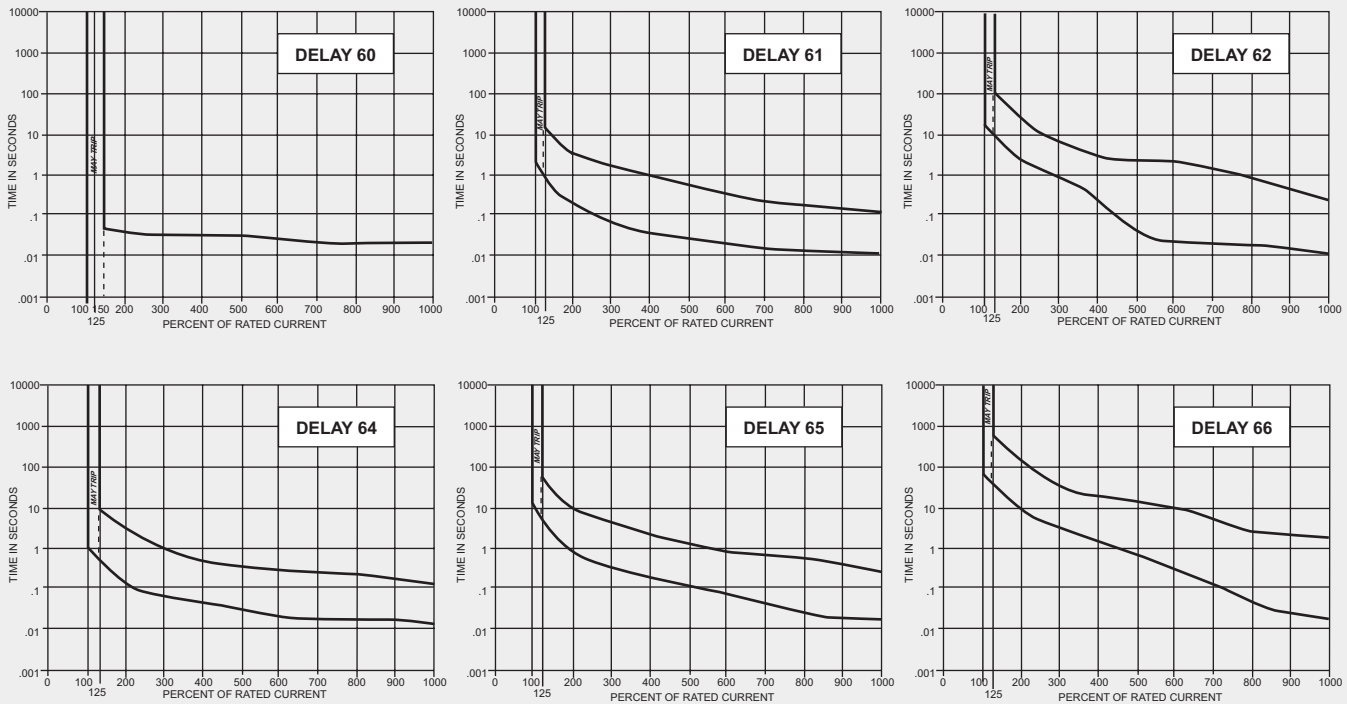

Fig. 25 Typical Airpax magnetic breaker time delays (50/60Hz). See individual products for specific delay curves.

Cross Trip/Common Tripping

It is a general misconception, when operating crosslinked handles on two or three pole protectors, that one handle pulls the other down when the protector trips.

Common trips are independent of the handles. In the six pole circuit protectors several poles can be turned on separately for sequencing of operations. But, if one trips, all will trip out. Circuit arrangement flexibility is immediately obvious. For example, two poles can be the AC line, and the third can be a voltage trip coil for remote control.

Handle movement is, of course, a fault indicator. Most magnetic protectors are trip free, meaning that the handle cannot be held against a fault; the mechanism will trip out anyway. When the handle is released later, it returns to the off position.

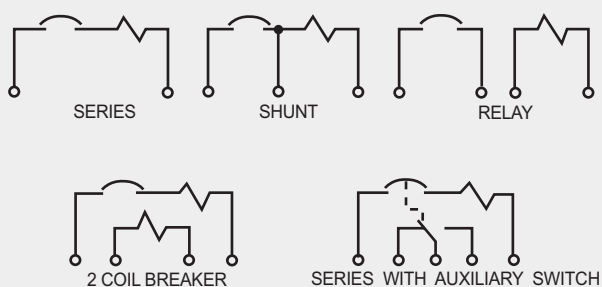

Fig. 26 Single pole breaker flexibility.

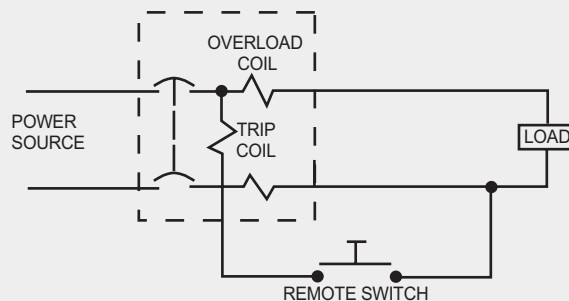

Fig. 27 Two coil breaker for remote tripping.

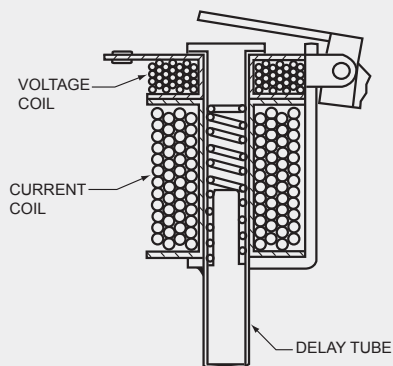

Fig. 28 Dual coil circuit breaker.

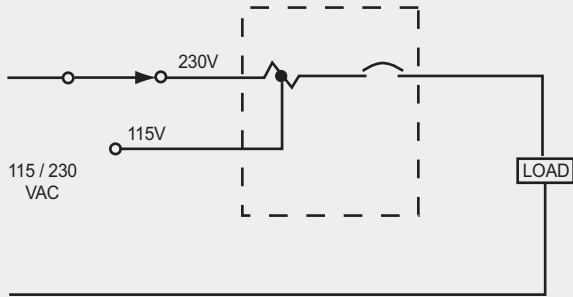

Fig. 30 115/230 volt tapped coil.

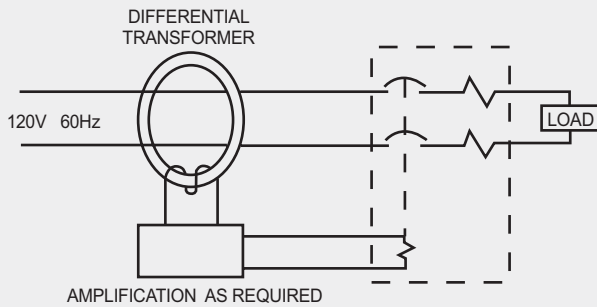

Fig. 31 Ground fault protection using differential transformer.

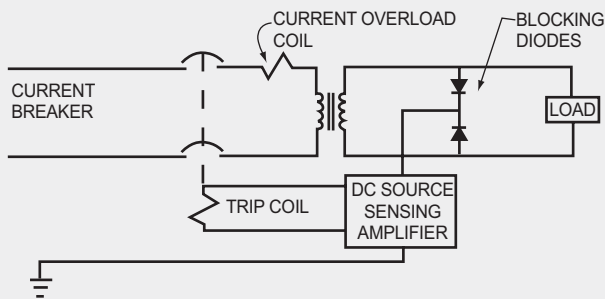

Fig. 32 Ground fault protection using isolation transformer.

115/230 VOLT PROTECTOR (TAPPED COIL)

A tapped coil permits using this protector in a system on both 115 and 230 volt service, as in Figure 30. Since the protector trip responds to ampere-turns, if the current is halved, the ampere-turns' product is maintained by doubling the turns.

GROUND FAULT INTERRUPT

Ground fault protection applied to motors and distribution systems will detect ground leakage across insulation before damage becomes extensive. Maintenance applied promptly can then save a great deal of expense.

Ground fault thresholds in such cases may range from milliamps, for protection of personnel, to several amps for equipment protection, and the time delay may be considerable.

If a current transformer is used to sense leakage to ground, the breaker supplier should be consulted for advice on a special circuit breaker with parameters which match the specific current transformer being used. On the other hand, for protection of personnel, an arrangement as shown in Figure 31 provides greater sensitivity when summing the currents in a differential toroidal transformer.

Today, ground fault interrupters can respond to currents which are only 1/20,000 of the full load current. Solid-state devices amplify this weak signal to help energize the magnetic protector trip coil.

Protection of personnel presents a different problem because the intensity of electric shock in a human is a function of current. Following are a few examples of the effect on humans:

- Example 1:
45 microamps, threshold on the tongue
- Example 2:
500 microamps, threshold on the skin
- Example 3:
10 to 15 milliamps, acute discomfort, let-go limit
- Example 4:
15 to 30 milliamps, muscles tighten, dangerous
- Example 5:
50 milliamps and up, heart fibrillation

For very low level fault currents, transformer isolation is needed (Figure 32). The National Electrical Code places special regulations for home facilities and devices where ground fault hazards could exist.

Crowbar Circuits

The versatility of the magnetic circuit breaker is evident when applied in electronic crowbar circuits. With help from the manufacturer, it's a simple task to provide a simple crowbar-type circuit which permits time delay opening of a circuit. For more information contact the manufacturer.

HOW MAGNETIC CIRCUIT BREAKERS WORK

All Airpax circuit protectors and circuit breakers are available in many mechanical and electrical configurations to provide maximum versatility for the designer. The following internal circuits are available on most breaker types and they usually can be combined in multi-pole units. Specific internal circuits for each magnetic circuit breaker type are alluded to in the following catalog pages.

Series Trip

This is the most popular configuration as the sensing coil and contacts are in series with the load being protected. Handle position conveniently indicates circuit status. In addition to providing conventional overcurrent protection, the unit can also be simultaneously used as an ON-OFF switch. The addition of an auxiliary switch operated by the internal mechanism would provide trip indication at a remote location.



Series Trip

Shunt Trip

The construction of the shunt trip circuit breaker is similar to that of the calibrating tap unit. The shunt trip circuit breaker is designed for controlling two separate loads with one breaker assembly. The control is established by providing overload protection for the critical load. When the current through this load becomes excessive and reaches the trip point, the breaker will open and remove power from both loads simultaneously. A shunt resistance added across the trip coil may be used to calibrate the trip level; hence the term "calibrating" tap.

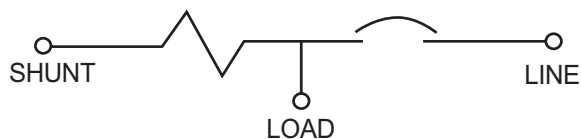

Shunt Trip

Relay Trip

Coil and contact leads are electrically and mechanically isolated in the relay trip configuration. This permits the overload sensing coil to be placed in a circuit which is electrically isolated from the trip contacts. The coil may be actuated by sensors monitoring pressure, flow, temperature, speed, etc. Other typical applications include crowbar, interlock, and emergency/rapid shutdown circuitry. Trip may be accomplished by voltage or current, which must be removed (usually self-interrupting) after trip. Consult factory on continuous duty applications.

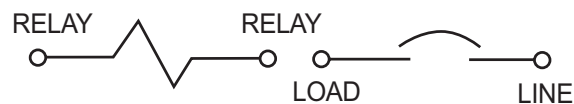

Relay Trip

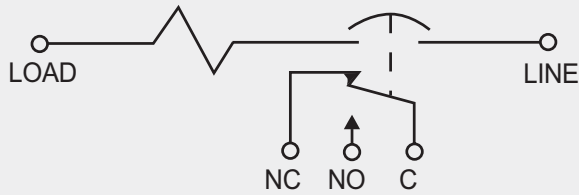

Auxiliary Switch

Note: Breaker Shown in "off" position.

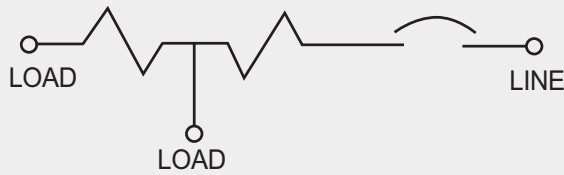

Dual Rating

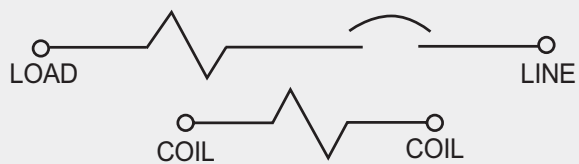

Dual Coil

Auxiliary Switch

An auxiliary switch can be furnished as an integral part of a series pole in single or multi-pole assemblies. Isolated electrically from the breaker circuit, the switch works in unison with the power contacts and provides indication at a remote location of the breaker's ON-OFF status.

Dual Rating

The dual rating circuit breaker is manufactured with tapped coil construction, which makes available the choice of two current ratings within a single pole unit. A prime example is a unit which allows 120 or 240VAC operation, without derating the protection at a higher voltage level. This type unit is available in all standard delays and frequencies except 64, 65, and 66 delays. Dual current ratings must be established and coordinated in order to give optimum protection. Factory consultation is available.

Dual Coil

By combining two electrically independent coils on a common magnetic circuit, it is possible to provide contact opening when either an over-current or trip voltage is applied to the respective coils. One coil will be a current trip coil with standard specifications. The second, or dual coil, can be used to provide a control function permitting contact opening from a remote interlock or other transducer functions. Standard coils are 6, 12, 24, 48, 120, and 240 volts. Tripping is instantaneous and must be removed (usually self-interrupting) after trip. Not available in delays 64, 65, 66.

Switch Only

In the event that over-current protection is not desired, the coil mechanism can be deleted, providing an excellent low cost, single or multi-pole power switch. Maximum current rating is 100 amperes.

Voltage Trip

All breakers can be supplied for voltage trip application, sometimes called "Dump Circuits" or "Panic Trip Circuits," which make it possible to open main power contacts with low power input from one or more sources. To match voltage trip applications, specify the minimum voltage that will be available to the coil and the frequency (DC, 50/60 or 400Hz).

Magnetic circuit breakers operate on the solenoid principle where a core, held with a spring in a tube and dampened with a fluid, may be moved by the magnetic field of a coil. As the core moves toward a pole piece, the reluctance of the magnetic circuit containing the armature is reduced. The armature is then attracted, causing the mechanism to trip and open the contacts on an overload or fault condition. This trip point occurs after a time delay when the core has made its full travel in the tube. The result is an inverse time delay and the trip time is decreased as the percent of overload is increased.

The fluid viscosity changes with temperature, causing the trip time of a magnetic breaker to decrease as temperature increases and vice versa. The trip current remains essentially unchanged despite changes in temperature, making possible accurate protection throughout the ambient temperature range without derating the breaker.

The instantaneous trip circuit is that value of current required to trip the circuit breaker without causing the core to move in the tube. This happens because the flux caused by a large overload or fault (six to ten times the breaker current rating) is sufficient to attract the armature.

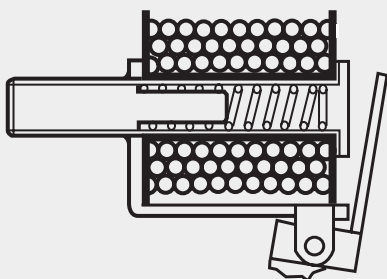

Coil current within rating.

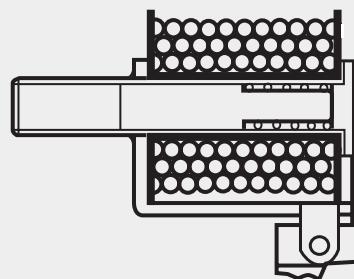

Coil current above rating.
Moderate overload.

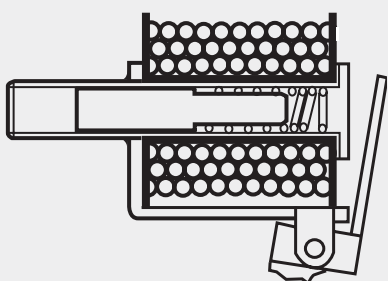

Moderate overload.
Armature operates after delay.

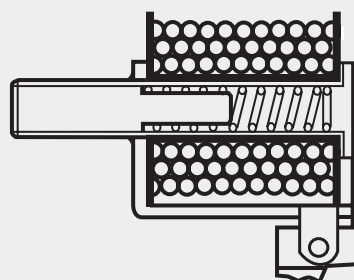

Current far above rating.
Armature trips without delay.

Delay Characteristics

A choice of delays is offered for DC, 50/60Hz, and 400Hz applications. Delays 40, 50, 60, 49, 59, and 69 provide fast-acting, instantaneous trip and are often used to protect sensitive electronic equipment. Delays 41, 51, and 61 have a short delay for general purpose applications. Delays 42, 52, and 62 are long enough to start certain types of motors and most transformer and capacitor loads. Delays 43 and 53 are long delays for special motor applications at 400Hz and DC. The following catalog pages provide delay curves and charts for each magnetic circuit breaker type.

Delays 64, 65, 66

Delays 64, 65, and 66 are the latest 50/60Hz delays with short, medium and long trip times respectively. The Airpax breaker design provides both increased tolerance to high inrush induced nuisance tripping, and longer trip times at 600 percent. These delays are ideally suited for applications where thermal devices are presently used, such as motor protection or where short duration high inrush currents are experienced. As shown in a typical motor start-up curve, the delay 66 will provide locked rotor and overload protection. Nuisance tripping is avoided since acceptable short periods of overload will not trip the breaker.

Inrush Pulse Tolerance

Many circuit protector applications involve a transformer turn-on, an incandescent lamp load, or a capacitor charge from a DC source. Each of these applications have one common factor: a steep wave front transient of very high current amplitude and short duration. This takes the form of a spike, or a single pulse, and is the cause of most nuisance tripping of circuit breakers.

The inertial delay provides tolerances of short duration inrush currents without decreasing steady state protection.

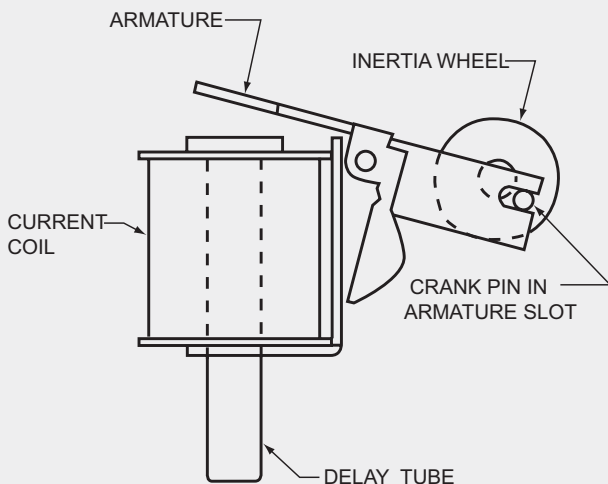

Inrush Pulse Tolerance

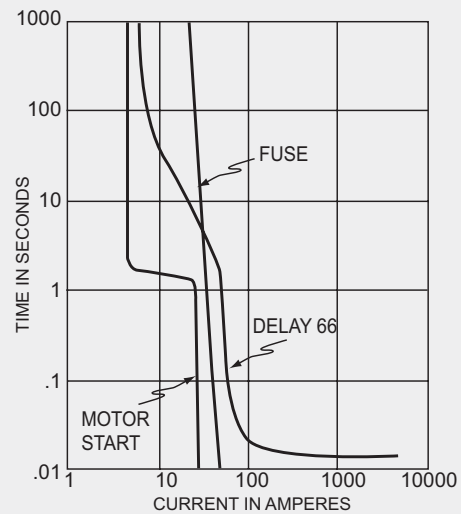

Delays 64,65,66

HOW TO USE AIRPAX™ MAGNETIC CIRCUIT BREAKERS

Here are just a few illustrations of magnetic circuit breakers in action. Since it is possible to select unique delays and operating currents from a wide range of available time delays and current ratings for each pole of multi-pole breakers, the number of possible combinations is greatly increased.

Generally, you may assume that any Airpax breaker type will qualify in most of the following examples. However, certain application needs dictate the selection of specific breaker types, as will be noted in our examples.

Example 1

Many magnetic circuit breakers perform double duty as ON-OFF switches, while providing overcurrent protection.

Example 2

In this illustration, a shunt trip, included in the circuit, performs the function of an ON-OFF switch, while providing a remote turn-off capability. This arrangement is useful when remote shutdown of equipment is necessary, as in emergency situations.

Example 3

Auxiliary contacts can be included in the magnetic circuit breaker to permit a remote indication of protector operation. These are available to safely carry up to 10 amperes at 250VAC and can be used to operate a non-critical load.

Example 4

The shunt coil of a magnetic circuit breaker can be in series with a thermostat that is strategically located on or near the load to provide protection against an excessive temperature rise.

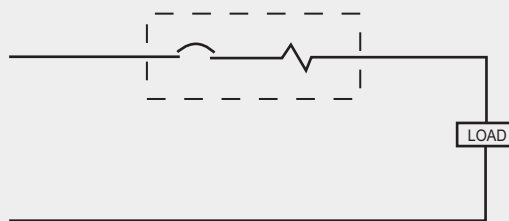

Example 1

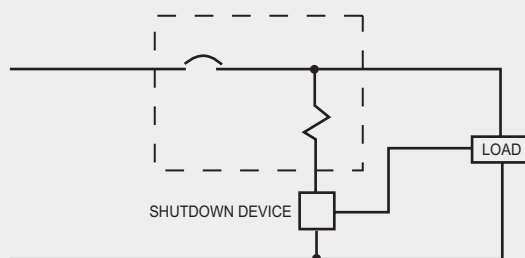

Example 2

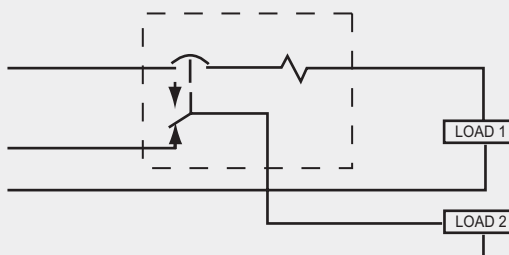

Example 3

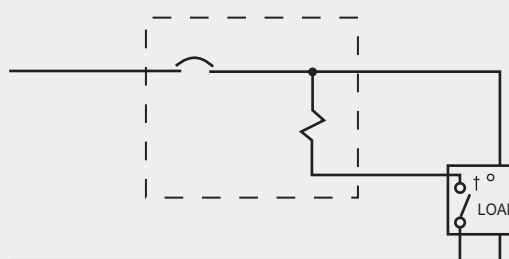

Example 4

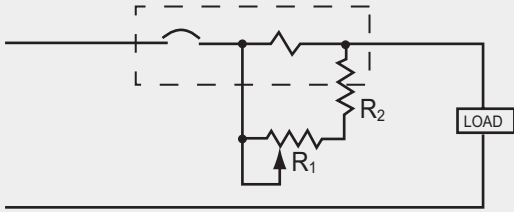

Example 5

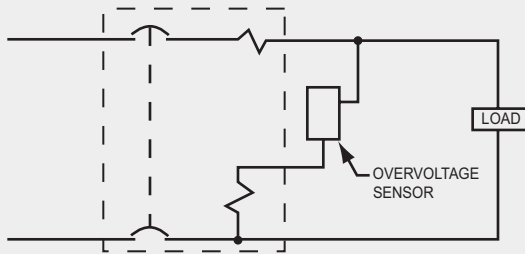

Example 6

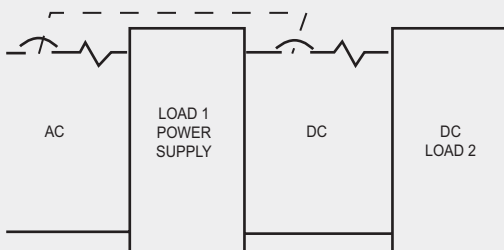

Example 7

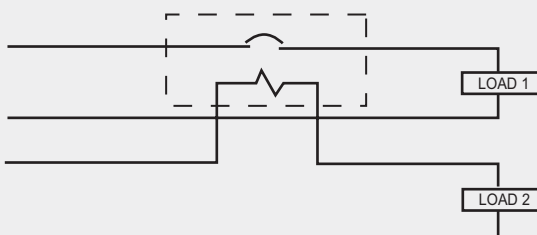

Example 8

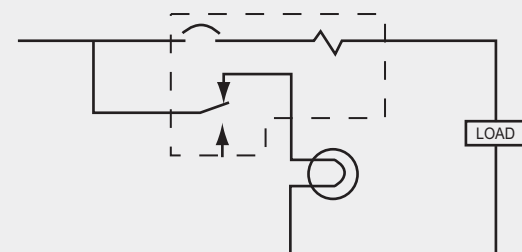

Example 9

Example 5

The trip point of a shunt trip type magnetic circuit breaker can be closely adjusted by varying a resistor. The resistor “R1” may be programmed to provide changes in the trip point as required by sequencing changes in the load. If “R1” is operator available, a fixed resistor “R2” should be added in series with “R1” to provide a minimum protection for the load in case of a zero resistance setting of “R1.”

Example 6

A two pole magnetic circuit breaker, configured with both a shunt trip and a series trip can be used to provide both overcurrent and over voltage protection.

Example 7

A two pole type magnetic circuit breaker can have a combination of two series poles, where one pole is protecting the power input to an AC/DC power supply, while the other pole is protecting the DC power output. In this configuration, an overload on the output side that causes a trip will remove the AC power.

Example 8

This magnetic circuit breaker is configured with its actuating coil and contacts internally isolated. The breaker senses an overcurrent condition in load 2 and opens the circuit to load 1. Both circuits may be opened, if desired, by using one series and one relay type in a two pole circuit breaker.

Example 9

When a type-RS auxiliary alarm switch is used, (available in UPL, IUL and IUG circuit protectors), the light will illuminate only in the event of an electrical trip of the main contacts. If an –REC or –RO type auxiliary switch is used, the light will indicate circuit condition regardless of how the main contacts are opened (manual or electrical trip).

Example 10

Dual coil magnetic circuit breakers in applications with remote control sensors can be configured so that their contacts will open at 125 percent or more of rated current, thereby providing load protection. This percentage will vary depending on such factors as frequency, current required and/or delay requested.

In addition, when the proper voltage is applied to the voltage coil by the remote control sensor, breaker contacts will open, removing power from the load. Voltage must be removed from the voltage trip coil and is usually self-interrupting. Control signals can come from sensors that sense temperature, pressure, flow, level, weight, etc., located in one or more strategic locations. The voltage coil can also be used to provide emergency shutdown from one or more remote locations.

Although shown as a single dual coil application, multiple poles (up to 9 poles on the APL/UPL and up to 4 poles on the APG/UPG) can be combined with the dual coil breaker in one of the poles to provide common trip of all poles. Because of physical space limitations and interaction of the two coils, the trip time of the current sensing coil may vary approximately 10 percent from the standard chart. Delays 43, 53, 64, 65, or 66 are not available in these configurations. It is suggested that you consult the factory with your application data.

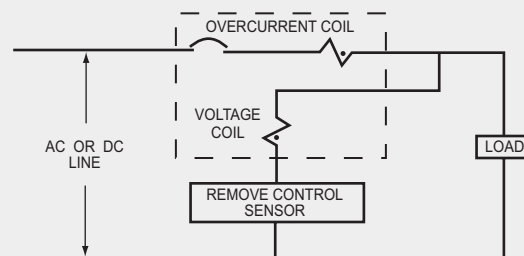

Example 10

Example 11

Voltage trip applications may have manual, remote, or automatic sensing such as in examples 2, 3 and 4. They may also have one or more sensors in parallel to actuate a single coil and open the associated contacts. Since the electromagnetic characteristics of the voltage trip pole are quite different from those of the current trip types, it is recommended that you contact a factory representative with your requirements.

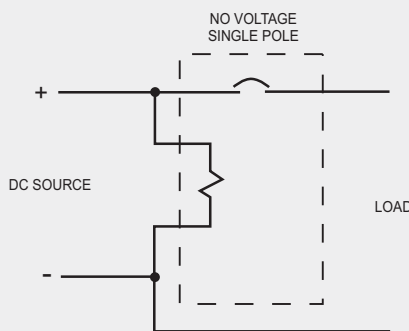

Example 12

Example 12

For no-voltage trip requirements, a special model designed to prohibit contact closure in the absence of DC voltage is available. By combining a no-voltage pole with overcurrent poles in a multi-pole assembly, it is possible to protect equipment from overcurrent, interruption, or loss of DC voltage. A bridge arrangement is required for all AC operation.

Example 13

Tapped Coil. There are applications where the source voltage may be either 115 or 230 volts with the 115 volt current being approximately twice that at 230 volts. Airpax APL/UPL, APG/UPG, and 203 are available with a tapped coil having this option in delays 60, 61 and 62. Tapped coil trip time may vary from the standard chart due to special, required construction. Current (I) combinations available are: APL/UPL, APG/UPG – 30/15, 22/10, 12/8, 10/5, 7.5/3.75, 5/2.5, 4/2, 2/1. The 203 is rated at 10/5 amps maximum. Consult factory with application data.

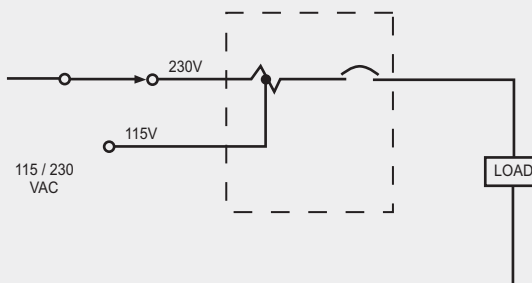

Example 13, 115/230 volt tapped coil.

DESIGNING FOR THE INTERNATIONAL MARKET

Markets can no longer be categorized simply as North American or European or Asian. Designers should view the market as an International one. In particular, the engineer must consider various performance and safety standards from around the world, especially in the data processing, medical and office equipment fields.

Most countries have regulatory agencies that determine the safety and performance standards required for products used in that country. For example: Underwriters Laboratories (UL) in the United States, Canadian Standards Association (CSA) in Canada, Verband Deutscher Elektrotechniker (VDE) in Germany, Schweizerischer Elektrotechnischer Verein (SEV) in Switzerland, etc.

The International Electrotechnical Commission (IEC) is a standards writing organization with the objective of correlating the various national safety standards and requirements, as agreed upon by representatives from the major countries in the world. Certification of conformance to IEC standards by UL is available, but IEC does not issue any kind of approval at this time nor does IEC have any legal authority to enforce its standards. However, this is expected to change in the future.

VDE standards are generally acknowledged as the most stringent standards enforced. Therefore, when designing for the international market, the engineer should choose components with both IEC certification and VDE approval to help assure acceptance of his product worldwide. IEC specifications generally meet or exceed the requirements of individual nations including VDE.

Additionally, we are registered by Underwriters Laboratories to ISO-9001. ISO-9001 is an International Quality Systems Standard that includes Quality Assurance in Production and Installation. Established by the International Organization for Standardization, Geneva, Switzerland, 1987, these standards are being adopted throughout the world by companies whose business priorities include customer satisfaction through Total Quality Management.

However, the designer must be aware that simply using a VDE approved or IEC certified breaker does not assure compliance. It is no longer a case of selecting the proper voltage, current and interrupt capabilities. An equipment manufacturer has to be aware of the operational and environmental conditions of the intended application. The circuit breaker selected must be approved for the specific standard to which the equipment is to be tested.

For example:

IEC 601

Safety of medical electrical equipment.

IEC 950

Safety of information technology equipment, including electrical business equipment.

VDE 0804

Particular safety requirements for equipment to be connected to telecommunication networks.

VDE 0805

Safety of information technology equipment, including electrical business equipment.

The circuit breaker manufacturer and the equipment manufacturer who uses the breaker must take into account four different aspects of the standard chosen: (1) the class of the equipment that the breaker is to be used in; and (2) the environmental conditions that the equipment must be qualified for have to be considered. (3) whether or not the breaker is operator accessible and (4) if the circuit breaker is to function as a disconnect device must also be determined.

The degree of "isolation" required must be identified. Isolation is determined by various operating conditions and is a combination of creepage, clearance and insulation. Clearance distance is defined as the shortest distance between two conductive parts or between a conductive part and the bounding surface of the equipment, measured through air. Creepage distance is the shortest path between two conductive parts or between a conductive part and the bounding surface of the equipment, measured along the surface of the insulation.

Some of the geometrics often encountered are shown in the following cases. A key dimension with respect to creepage is 1 mm.

If a gap is less than 1 mm, the gap is considered nonexistent; if the gap is greater than 1 mm, the creepage path follows the surface.

Case 1

Condition: Path under consideration includes a parallel-or converging sided groove of any depth with a width less than 1 mm.

Rule: Creepage distance and clearance are measured directly across the groove as shown.

Case 2

Condition: Path under consideration includes a parallel sided groove of any depth and equal to more than 1 mm wide.

Rule: Clearance is the "line of sight" distance. Creepage path follows the contour of the groove.

Case 3

Condition: Path under consideration includes a V shaped groove with an internal angle of less than 80° and a width greater than 1mm.

Rule: Clearance is the "line of sight" distance. Creepage path follows the contour of the groove but "short circuits the bottom of the groove by 1 mm. (0.25 mm for dirt-free situations) link.

Case 4

Condition: Path under consideration includes a rib.

Rule: Clearance is the shortest direct air path over the top of the rib. Creepage path follows the contour of the rib.

Case 5

Condition: Path under consideration includes an uncemented joint with grooves less than 1 mm (0.25 mm for dirt-free situations) wide on either side.

Rule: Creepage and clearance path is the "line of sight" distance shown.

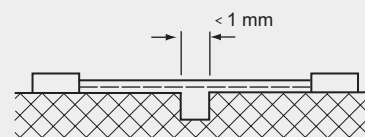

Case 1

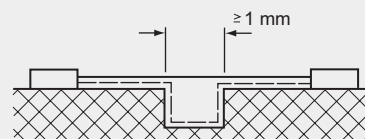

Case 2

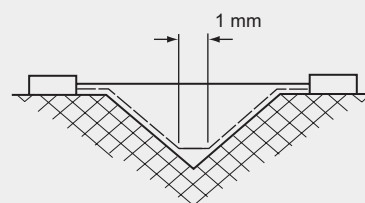

Case 3

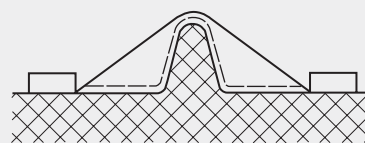

Case 4

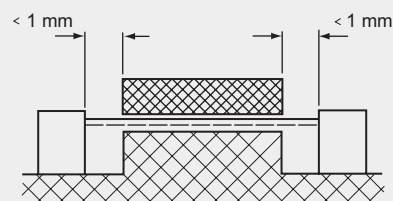

Case 5

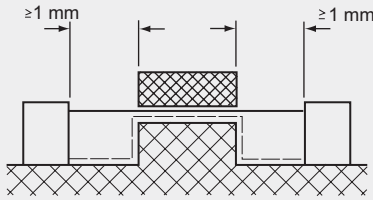

Case 6

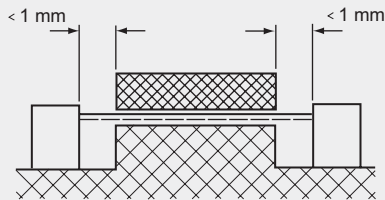

Case 7

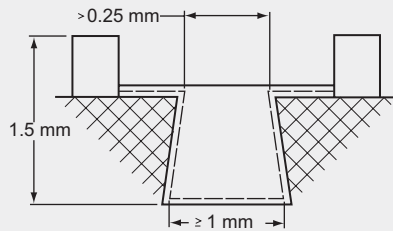

Case 8

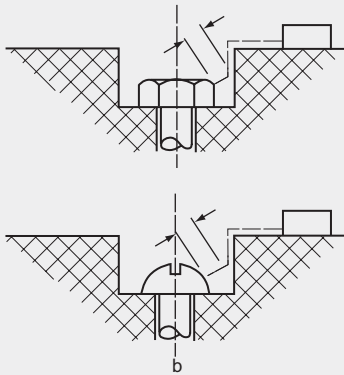

Case 9

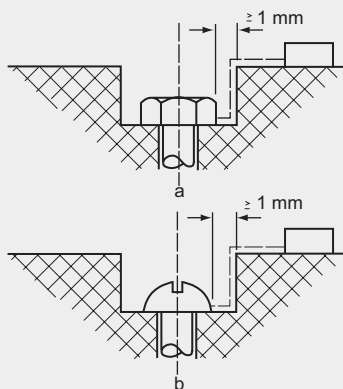

Case 10

Case 6

Condition: Path under consideration includes an uncemented joint with grooves equal to more than 1 mm wide each side.

Rule: Clearance is the "line of sight" distance. Creepage path follows the contour of the grooves.

Case 7

Condition: Path under consideration includes an uncemented joint with a groove on one side less than 1 mm wide and a groove on the other side equal to or more than 1 mm wide.

Rule: Clearance and creepage paths are as shown.

Case 8

Condition: Path under consideration includes a diverging-sided groove equal to or greater than 1.5 mm deep and greater than 0.25 mm wide at the narrowest part and equal to or greater than 1 mm at the bottom.

Rule: Clearance is the "line of sight" distance. Creepage path follows the contour of the groove.

Case 9

Gap between head of screw and wall of recess too narrow to be taken into account.

Case 10

Gap between head of screw and wall of recess wide enough to be taken into account.

IEC CLASSES OF ELECTRICAL EQUIPMENT

There are four classes that IEC uses to categorize electrical equipment.

Class I

Defined as equipment which does not depend upon insulation only, but has an added safety precaution in that all non-energized conductive parts are connected to an earthing conductor in the fixed wiring of the installation, such that they cannot become live in the event of insulation failure. Circuit breakers designed to meet this criteria have more stringent isolation requirements than those designed for Class III and may be used in either Class I or III equipment. Under suitable conditions, a circuit breaker designed to meet this class may be used in Class II equipment as an inaccessible component.

Class II

Equipment depends entirely upon isolation (creepage, clearance and/or insulation) to provide protection. This equipment has the most stringent isolation requirements and circuit breakers designed to meet this criteria may be used in any other class of equipment.

Class III

Safety Extra Low Voltage (SELV) is defined as equipment which provides the protection required by being designed so that the voltage cannot ever reach a hazardous level. Circuit breakers designed for this class of equipment have the minimum isolation requirements and are not to be used in any other class of equipment. However, under suitable conditions it may be used as an inaccessible unit for hazardous voltages.

Class IV

Extra Low Voltage (ELV) is sometimes considered. However, since the power supply may not always be a SELV unit, circuit breakers designed for use in this equipment must meet the requirements of either Class I or II. This class may be ignored because low voltage is considered hazardous unless it is SELV.

Airpax circuit protector types IPG, IEG, IEL and SNAPAK have been examined by UL and are in compliance with the requirements of Class II of IEC 435, which is the most stringent of those standards listed and thus could be used for any of the four classes.

Another decision deals with environmental conditions which are divided into a range of pollution degrees. Pollution Degree #1 requiring the least protection and #4 requiring the most. The circuit breaker industry has generally adopted Pollution Degree #3 as the basic design standard for the greatest economical advantage since it does not require the extreme precautions of Pollution #4. An equipment manufacturer may use this unit in equipment designed for Pollution Degree #4 by providing suitable auxiliary physical protection such as an additional cover or enclosure around the circuit breaker. Pollution Degree #3 is defined as "Conductive pollution occurs or dry non-conductive pollution occurs which becomes conductive due to condensation which is expected."

LEAKAGE CURRENT TEST

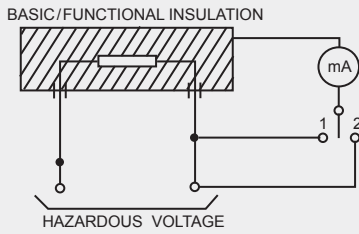

Figure 1

LEAKAGE CURRENT TEST
FOR CLASS II MACHINE

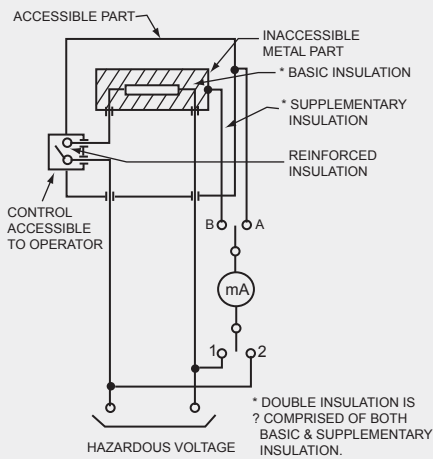

Figure 2

CLASSES OF INSULATION

A third decision concerns classes of insulation. There are five classes of insulation to be considered:

Case 1

Operational insulation (Figure 1) is the insulation provided between live parts of different potential which is necessary for proper operation of the unit. This may be considered as line to line insulation.

Case 2

Basic insulation (Figure 2) is the insulation applied to live parts for protection against electric shock. This requires 3mm clearance and 4mm creepage up to 400V rms.

Class 3

Supplementary insulation is an independent insulation applied to basic insulation to ensure protection against electric shock in event of failure of the basic insulation.

Case 4

Double insulation is comprised of both basic and supplementary insulation.

Case 5

Reinforced insulation is a single insulation applied to live parts which provides a degree of protection against electric shock equivalent to double insulation. This requires 8mm creepage and clearance up to 250V rms, and 8mm clearance and 10mm creep-age up to 570V rms.

Double or reinforced insulation must be designed into circuit breakers if they are to be used as accessible components. Basic or supplementary insulation are sufficient for units considered inaccessible, assuming that the application does not mix hazardous and SELV voltages in the same circuit breaker.

If the circuit breaker is to be used as a disconnect device, the open contacts must be separated by at least 3mm.

COMBINATIONS

At Airpax, our assumptions are that worst case combinations on circuit breakers designed to meet these international requirements are as follows:

Case 1

The equipment designed will be Class II and the circuit breaker operating handle is operator accessible. This requires that creepage and clearance both be 8mm from the base of the handle to any electrically energized internal part of the circuit breaker up to 250V. Higher voltages require greater clearance and creepage.

Case 2

Hazardous and SELV voltages will be mixed in adjacent poles of a multi-pole unit. This requires the same creepage and clearance as in Case 1 between the adjacent poles.

Case 3

On a pole with an auxiliary switch, hazardous and SELV voltages may be mixed, such as 240V on the main contacts and 5V (from a SELV rated source) on the auxiliary switch. This requires the same creepage and clearance between electrically energized parts of the circuit breaker mechanism and the switch mechanism as in Case 1 above.

Equipment designers must be especially cautious about a design that requires mixing hazardous and SELV voltages. If the application is all hazardous or all SELV, the creepage and clearance requirements are 3 or 4mm, depending upon which standard the equipment will be tested to. The 8mm always applies around the handle if it is operator accessible.

The equipment designer has a responsibility to investigate the appropriate standards and know precisely what kind of approvals are required for circuit breakers and other components. The component manufacturers have the obligation of clearly communicating to potential users precisely what kind of approvals their products have. With this information, the equipment designer is assured that he has a proper match.

The two examples below illustrate how possible confusion can arise if careful attention is not given to the requirements of the specific equipment application.

Example 1

The first is the SNAPAK® circuit protector line. This protector has been certified by UL to IEC Standard 435 for Class II, front panel use. SNAPAK has passed the functional requirements of VDE 0642, and carries the VDE logo.

Example 2

The second is the IEG and IEL families. These protectors have been certified by UL to IEC standard 435 to Class II, front panel use. They have passed the functional requirements of VDE 0642, and as a result are now qualified to carry the VDE logo.

These two very similar sounding approvals are not the same. What is the difference? The difference is the insulation class. The SNAPAK circuit breaker family is approved for operational or basic insulation and the IEG and IEL families are approved for double or reinforced insulation.

What does that difference mean to the user? It means that hazardous and SELV voltages can be mixed on the IEG and IEL and not on the SNAPAK, because it does not have the 8mm clearance pole to pole internally. However, it does have the required 8mm clearance between the auxiliary switch and the main circuit. In addition, the contacts must have at least a 3mm opening in the OFF position if the breaker is used as a disconnect device and the operating environment must be no worse than Pollution Degree #3.

Circuit Breaker Selection

To select a properly approved circuit breaker for an individual application, the following points should be considered.

Point 1

Equipment Class I, II, III.

Point 2

Pollution Degree 1, 2, 3, 4.

Point 3

Insulation Class. (See Note).

Point 4

Operator Accessible — Yes, No.

Point 5

Used as a disconnect device — Yes, No.

Make sure that the circuit breaker approval meets or exceeds the criteria in the checklist. Do not assume that any unit with the VDE logo will meet your needs.

The preceding is a summary of inputs from many engineers in our customer base and consultations with VDE personnel. It is intended as a guide in the circuit protection selection process and should not be viewed as absolute, in that the various standards are subject to change and no two applications are precisely the same. We suggest communication between the equipment design engineer and the application engineering staff at Airpax.

Note: Will be a function of whether or not hazardous and SELV voltages are mixed.

AIRPAX®

6600 & 6700 Series Subminiature Bimetal Disc Thermostats



6600 Series • 33

6700 Series • 37

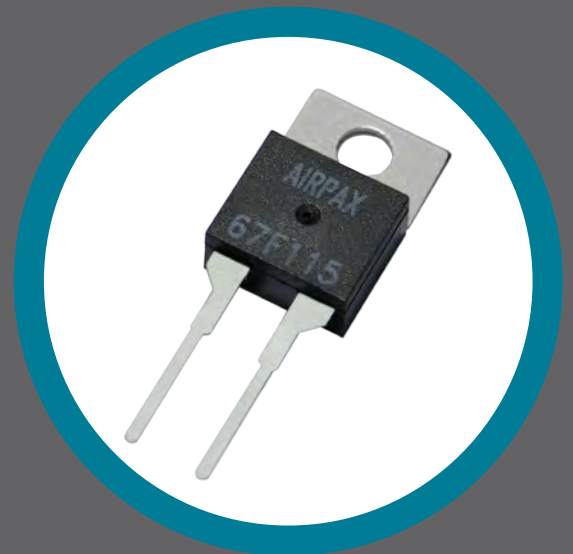

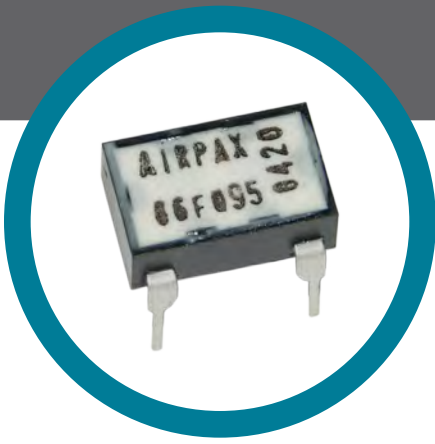

AIRPAX® | 6600 Series

8-Pin DIP, Subminiature Bimetal Disc Thermostat

FEATURES

- RoHS compliant per EU directive 2002 / 95 / EC
- 8-pin DIP international electronic package standard
- Ideal for surface and air sensing on PC boards
- Gold-plated contacts
- Up to 30,000 life cycles @ max standard amperage (120VAC)
- Up to 100,000 life cycles @ max gold contact amperage

DESCRIPTION

The Airpax™ 6600 series is a RoHS compliant, positive snap action, single pole / single throw, sub-miniature bimetallic thermostat which provides accurate and reliable sensing and switching in a single device.

The 6600 series thermostat dimensionally conforms to the international product package standard 8-pin DIP (N8A Dual Inline Package). The 6600 is ideally suited for use on printed circuit boards. Its size and shape conserves space on crowded PC boards and can be installed using auto-insertion equipment. The device is sealed to withstand wave soldering and board washing operations.

The 6600 provides fast, positive response with excellent repeatability. The thermostat has a switch capability of up to 1 amp for 48 VDC or 120 VAC, and achieves low-level switching down to 0.001 A to 0.020 A at 5 VDC for 100,000 cycles. Temperature is pre-set at the factory and is non-adjustable in the field.

Applications include computers and computer peripherals, aircraft, automotive and test equipment. Typical uses include turning on an indicator light, sounding an audible alarm, switch on a control circuit to send a message to a display screen or even switching a circuit to shut down a system.

The 6600 thermostat is temperature tested in a computer controlled automated test equipment air-oven. Due to the ideal conditions under which it is tested, independent customer testing may be necessary to ensure that the correct calibration is utilized in the application.

It is the customer's responsibility to determine whether the product is proper for customer's use and application.

OPERATION SCHEMATICS

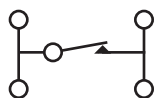

Schematic for
Open on Rise
Operation

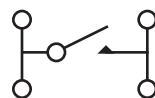

Schematic for
Close on Rise
Operation

SPECIFICATIONS

| | | | |
|---------------------------------------|--|---------|--|
| Contact Resistance | 50 milliohms max (before and after rated life) | | |
| Contact Ratings | Cycles | Voltage | Amps (resistive) |
| | 25,000 | 48 VDC | 1.0 |
| | 30,000 | 120 VAC | 1.0 |
| | 100,000 | 5 VDC | 0.001 (gold) |
| Contact Operations | Either close on rise (make) or open on rise (break) | | |
| Operating Temperature | 40°C to 130°C (104°F to 266°F) | | |
| Temperature Tolerance | Standard of $\pm 5^{\circ}\text{C}$ ($\pm 9^{\circ}\text{F}$) with nominal operating temperature settings in 5°C increments | | |
| Short Term / Long Term Exposure Limit | Short = 260°C (500°F), 10 second duration | | Long = -55°C to 160°C (-67°F to 320°F) |
| Dielectric Strength | 1480 VAC 60Hz, 1 second duration terminals to case | | |
| Insulation Resistance | 100 Mohms at 500 VDC | | |
| Contact Bounce | 3 milliseconds max (make) | | |
| Vibration | Per Mil-Std-202, method 204D, test condition D, 10 to 2,000 Hz | | |
| Shock | Per Mil-Std-202, method 213, test condition C, 100 G's for 6 millisecond duration, ½ sine wave | | |
| Seal | High temperature epoxy sealed for wave soldering and cleaning, moisture proof per Sensata specification S-722 (unit will not leak while submerged in 9" of water for a minimum of two minutes) | | |
| Base Material | PPS (Polyphenylene Sulfide), 94 VO rated | | |
| Terminal Material | 65% Copper, 18% Nickel | | |
| Contact Material | Gold-plated or overlay, silver crossbar | | |
| Chemical Resistance | Unit is resistance to water, salt, alcohol, ammonia, trichlorethane and most other organic solvents | | |
| Soldering Heat Resistance | Per Mil-Std-202F, method 210A, test condition E | | |
| Weight | Approximately 0.45 grams | | |
| Mechanical Life | 1,000,000 operations | | |
| Agency Approvals | cRUus recognized E36687 VDE approval 0631/12.83 RoHS Compliant per EU Directive 2002/95/EC | | |

DIMENSIONAL SPECIFICATIONS, inches [mm]

Standard 8-Pin DIP Configuration

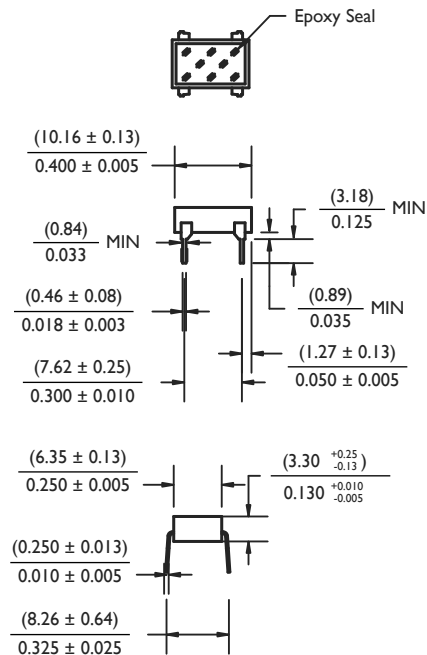

Surface Mount (Gullwing, SMT) Configuration

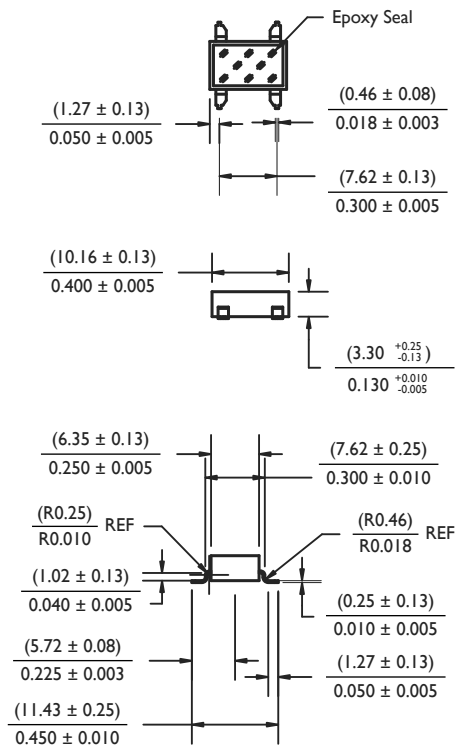

STANDARD PACKAGING

Standard and surface mount samples and production orders will be shipped in plastic, industry standard DIP shipping tubes.

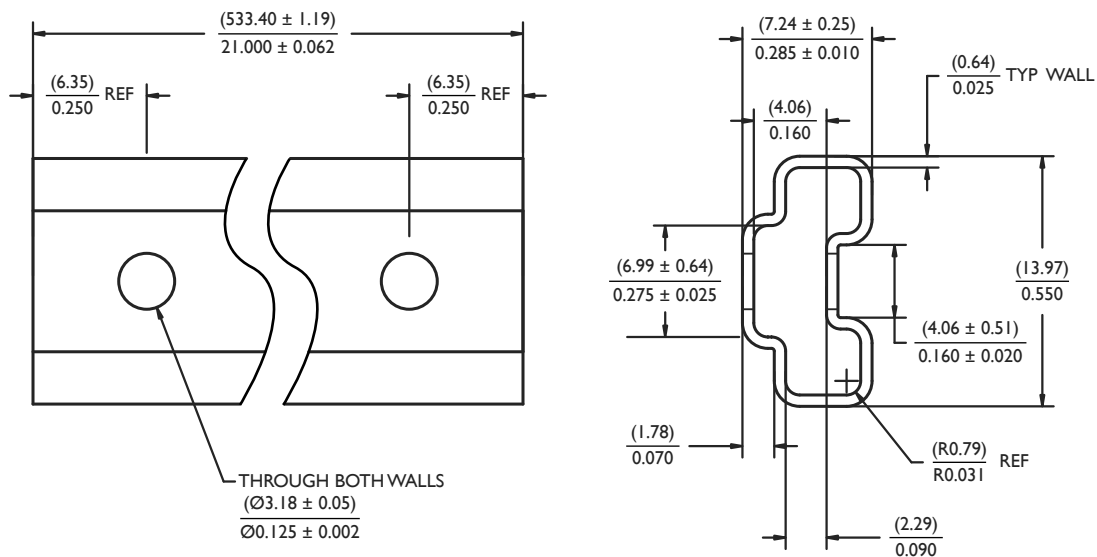

STANDARD TEMPERATURE CALIBRATION TABLE

Each thermostat part number consists of functional “building blocks” to enable the user to specify clearly and precisely the desired characteristics in each category. Select the proper code in each category, then transfer it to the box indicated. Unless a special requirement is indicated, the part number will be complete when the proper temperature is selected. If you have a special requirement, please call Sensata for a factory assigned number to complete the part number.

Example :

A 66F095 thermostat will close (make contact) on a rising temperature from 90°C to 100°C and will reset open (break contact) on a falling temperature within a window of no greater than 6°C lower than the actual close temperature and no less than 60°C ambient temperature.

Special requirements require a 4 digit manufacturing dash number for ordering special features, 4 digit marking may not appear as part of the marking on the thermostat.

Special requirements may include VDE, $\pm 3.0^{\circ}\text{C}$ ($\pm 5.4^{\circ}\text{F}$) operating temperature tolerance, or surface mount (gullwing, SMT).

Temperature set point calibration is checked at Sensata Technologies with precision test equipment traceable to the US National Institute of Standards and Technology and Proven Methods. Because customer checking methods may differ, a typical variance allowed for correlation is $\pm 1.1^{\circ}\text{C}$ ($\pm 2.0^{\circ}\text{F}$).

| OPERATE ($\pm 5^{\circ}\text{C}$) | MIN DIFFERENTIAL ($^{\circ}\text{C}$) | MIN RESET ($^{\circ}\text{C}$) |
|-------------------------------------|---|----------------------------------|
| 40 | 4 | 20 |
| 45 | 4 | 20 |
| 50 | 4 | 30 |
| 55 | 4 | 30 |
| 60 | 4 | 40 |
| 65 | 4 | 40 |
| 70 | 4 | 50 |
| 75 | 4 | 50 |
| 80 | 6 | 55 |
| 85 | 6 | 55 |
| 90 | 6 | 60 |
| 95 | 6 | 60 |
| 100 | 6 | 70 |
| 105 | 6 | 70 |
| 110 | 6 | 80 |
| 115 | 6 | 85 |
| 120 | 9 | 90 |
| 125 | 9 | 90 |
| 130 | 9 | 90 |

DECISION TABLES

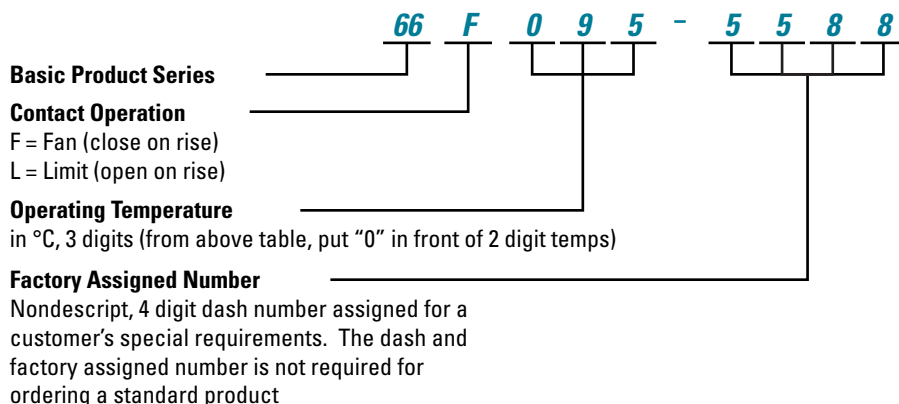

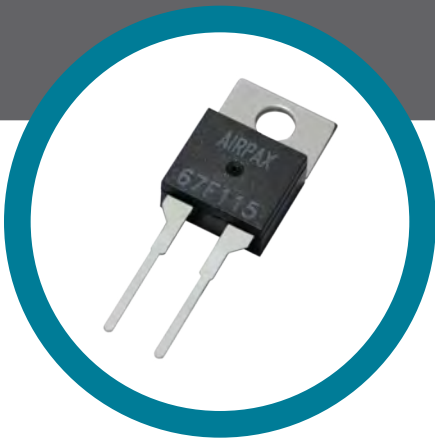

AIRPAX® | 6700 Series

TO-220, Subminiature Bimetal Disc Thermostat

FEATURES

- RoHS compliant per EU directive 2002 / 95 / EC
- TO-220 / Y-220 international electronic package standard
- Ideal for surface and air sensing on PC boards and heat sinks
- VDE approved with "P" bracket option
- Gold-plated contacts
- Up to 20,000 life cycles @ max standard amperage
- Up to 100,000 life cycles @ max gold contact amperage

DESCRIPTION

The Airpax™ 6700 series is a RoHS compliant, positive snap action, single pole / single throw, sub-miniature bimetallic thermostat which provides accurate and reliable sensing and switching in a single device.

The 6700 series thermostat dimensionally conforms to the international product package standard Y220 / TO220. Thus, the 6700 may be automatically placed and soldered onto PC boards with high speed automated equipment, eliminating the need for the expensive hand placement and termination required today for most power supply thermostats.

The 6700 provides fast, positive response with excellent repeatability. The thermostat has a switch capability of up to 0.5 amp for 48 VDC, and achieves low-level switching down to 0.001A to 0.020A at 5 VDC for 100,000 cycles. Temperature is pre-set at the factory and is non-adjustable in the field.

Thermal conductivity is mainly through the terminals and the mounting bracket making the unit ideal for both surface mount and ambient air sensing. The nickel-plated copper mounting bracket comes standard, or you can utilize the laminated plastic mounting bracket for increased dielectric strength and VDE approval.

Primarily developed for thermal management applications on power supplies, the Airpax™ 6700 series is also ideally suited for use on crowded PC boards. Typical uses include turning on an indicator light, sounding an audible alarm, switch on a control circuit to send a message to a display screen or even switching a circuit to shut down a system. Applications include computers and computer peripherals, aircraft, automotive, medical devices and test equipment.

OPERATION SCHEMATICS

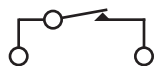

Schematic for
Open on Rise
Operation

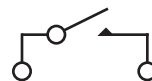

Schematic for
Close on Rise
Operation

SPECIFICATIONS

| | | | |
|---------------------------------------|--|---------|--|
| Contact Resistance | 50 milliohms max (before and after rated life) | | |
| Contact Ratings | Cycles | Voltage | Amps (resistive) |
| | 20,000 | 48 VDC | 0.5 |
| | 100,000 | 5 VDC | 0.001 (gold) |
| Contact Operations | Either close on rise (make) or open on rise (break) | | |
| Operating Temperature | 40°C to 130°C (104°F to 266°F) | | |
| Temperature Tolerance | Standard of $\pm 5^{\circ}\text{C}$ ($\pm 9^{\circ}\text{F}$) with nominal operating temperature settings in 5°C increments | | |
| Short Term / Long Term Exposure Limit | Short = 260°C (500°F), 10 second duration | | Long = -55°C to 160°C (-67°F to 320°F) |
| Dielectric Strength | Nickel-plated copper bracket has 1480 VAC 60Hz, 1 second duration terminals to case. Plastic bracket has 2000 VAC 60Hz, 1 second duration terminals to case. | | |
| Insulation Resistance | 100 Mohms at 500 VDC | | |
| Contact Bounce | 3 milliseconds max (make) | | |
| Vibration | Per Mil-Std-202, method 204D, test condition D, 10 to 2,000 Hz | | |
| Shock | Per Mil-Std-202, method 213, test condition C, 100 G's for 6 millisecond duration, ½ sine wave | | |
| Seal | High temperature epoxy sealed for wave soldering and cleaning, moisture proof per Sensata specification S-722 (unit will not leak while submerged in 9" of water for a minimum of two minutes) | | |
| Base Material | PPS (Polyphenylene Sulfide), 94 VO rated | | |
| Terminal Material | 65% Copper, 18% Nickel | | |
| Contact Material | Gold-plated or overlay, silver crossbar | | |
| Mounting Bracket Material | Nickel-plated copper (standard) or high pressure laminated plastic ("P" mounting bracket option) | | |
| Chemical Resistance | Unit is resistance to water, salt, alcohol, ammonia, trichlorethane and most other organic solvents | | |
| Solderability | Terminal material is selectively striped with lead-free solder for improved solderability. | | |
| Soldering Heat Resistance | Per Mil-Std-202G, method 210F, test condition C & K, test condition K validated at 260°C for 25 seconds | | |
| Weight | Approximately 0.5 grams | | |
| Agency Approvals | cRUus recognized E36687 VDE approval 0631/12.83 RoHS Compliant per EU Directive 2002/95/EC | | |

DIMENSIONAL SPECIFICATIONS, inches [mm]

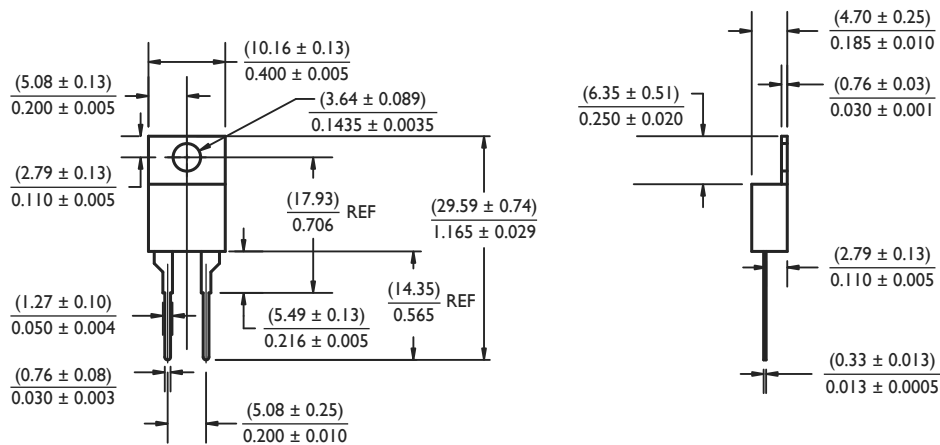

STANDARD PACKAGING

All samples and production orders will be shipped in plastic, industry standard shipping tubes.

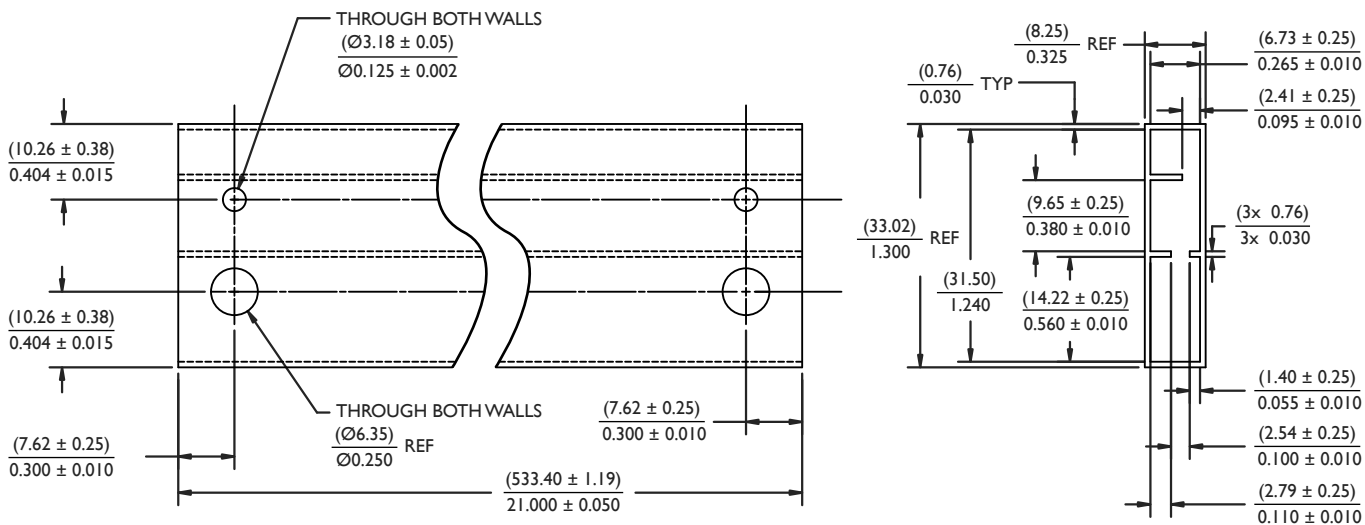

STANDARD TEMPERATURE CALIBRATION TABLE

Each thermostat part number consists of functional “building blocks” to enable the user to specify the desired characteristics. Select the proper code in each category, then transfer it to the box indicated. Unless a special requirement is indicated, the part number will be complete when the proper temperature is selected. If you have a special requirement, please call Sensata for a factory assigned number to complete the part number.

Example 1:

A 67F090 thermostat will close (make contact) on a rising temperature from 85°C to 95°C and will reset open (break contact) on a falling temperature within a window of no greater than 6°C lower than the actual close temperature and no less than 60°C ambient temperature.

Example 2:

A 67L060P thermostat has a plastic mounting bracket with 2000 VAC dielectric strength and VDE approval. The thermostat will open (break contact) on a rising temperature from 55°C to 65°C and will reset close (make contact) on a falling temperature within a window of no greater than 4°C lower than the actual open temperature and no less than 40°C ambient temperature.

The mounting bracket designation and the 4 digit manufacturing dash number are used for ordering special features and may not appear as part of the marking on the thermostat.

Temperature set point calibration is checked at Sensata Technologies with precision test equipment and proven methods. Because customer checking methods may differ, a typical variance allowed for correlation is $\pm 1^\circ\text{C}$.

| OPERATE ($\pm 5^\circ\text{C}$) | MIN DIFFERENTIAL ($^\circ\text{C}$) | MIN RESET ($^\circ\text{C}$) |
|--------------------------------------|--|-----------------------------------|
| 40 | 4 | 20 |
| 45 | 4 | 20 |
| 50 | 4 | 30 |
| 55 | 4 | 30 |
| 60 | 4 | 40 |
| 65 | 4 | 40 |
| 70 | 4 | 50 |
| 75 | 4 | 50 |
| 80 | 6 | 55 |
| 85 | 6 | 55 |
| 90 | 6 | 60 |
| 95 | 6 | 60 |
| 100 | 6 | 70 |
| 105 | 6 | 70 |
| 110 | 6 | 80 |
| 115 | 6 | 80 |
| 120 | 9 | 85 |
| 125 | 9 | 85 |
| 130 | 9 | 90 |

DECISION TABLES

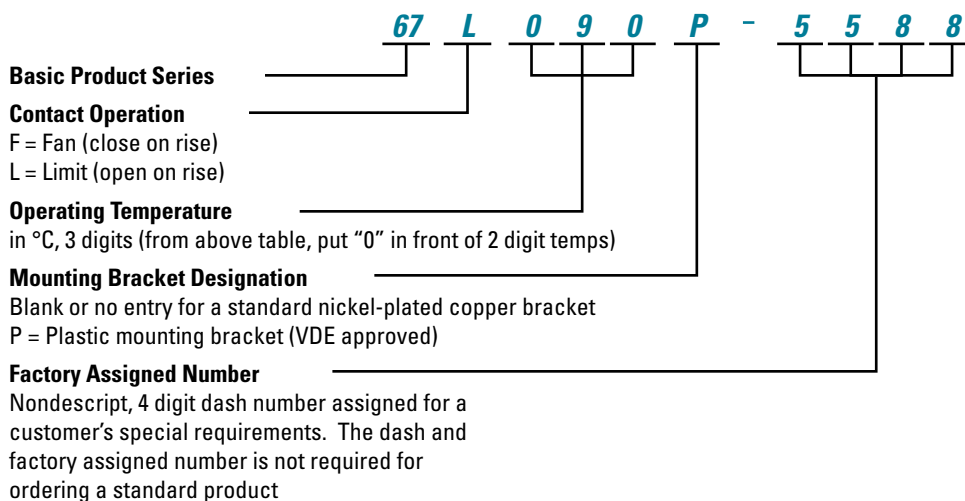

AIRPAX®

IAR/IUR/IER/CUR/CER Series "1U, 1RU" Magnetic Circuit Protectors



- Introduction* • 43
- Poles & Terminals* • 44
- Configurations* • 47
- Delay Curves & Specifications* • 48
- Operating Characteristics* • 49
- Hardware* • 50
- Decision Tables* • 51





AIRPAX® | IAR/IUR/IER/CUR/CER Series

"1U, 1RU" Hydraulic Magnetic Circuit Protectors

FEATURES

- UL1077, TÜV, UL489A approved
- Designed to fit in a "1RU" application
- 5000 AIC (80VDC), 2000 AIC (250VAC) interrupt capacity
- Series or mid-trip with auxiliary switch alarm options
- Various delays including motor start
- 1 to 2 poles, multiple termination options

INTRODUCTION

The Airpax™ IAR/IUR/IER/CUR/CER series is a snap-acting hydraulic-magnetic circuit breaker / protector that combines power switching and accurate, reliable circuit protection in one aesthetically pleasing, "1U" or "1RU" sized package.

Designed for rack mount applications, the IAR/IUR/IER/CUR/CER series allows efficient use of rack space without sacrificing performance via proven hydraulic-magnetic technology that provides consistent operation from -40°C to 85°C, with a circuit interrupt capacity up to 5,000 AIC at 80VDC and 2,000 AIC at 250VAC. Available in series trip and mid-trip configurations, with auxiliary alarm switch options to provide monitoring of critical circuits.

The CER series circuit breaker provides the necessary ratings for wireless and wired applications while meeting UL489A and TÜV requirements for approval.

APPROVALS

| Ratings | Voltage | A.I.C. | Agency Approvals | Poles |
|--------------|---------|--------|------------------------------|-------|
| 2 to 65 amps | 80VDC | 5,000 | UL489A, TÜV EN60947-2 & C-UL | 1 |
| 2 to 50 amps | 80VDC | 5,000 | UL1077, TÜV EN60943 & C-UL | 2 |
| 2 to 50 amps | 250VAC | 2,000 | UL1077, TÜV EN60943 & C-UL | 2 |

POLES & TERMINALS

The Airpax™ IAR/IUR/IER/CUR/CER series is available with one or two poles with various bullet, stud and screw terminals. Engineered for safe, sure operation, the toggle handles may be specified in blue, white, red, orange, green, yellow or black.

Single Pole

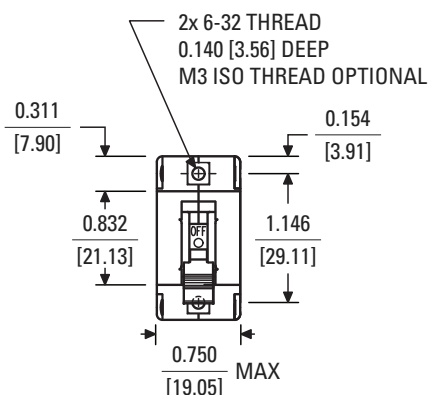

Two Pole
(with or without two handles)

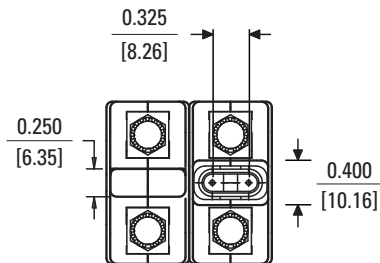
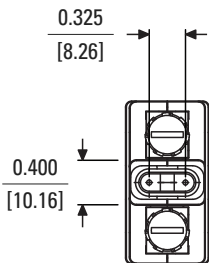
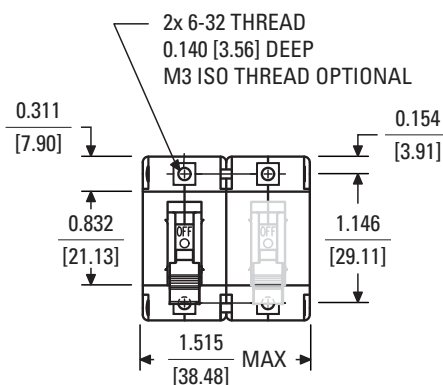

Auxiliary switch wires not shown for clarity

Panel Mounting Detail, Single Pole

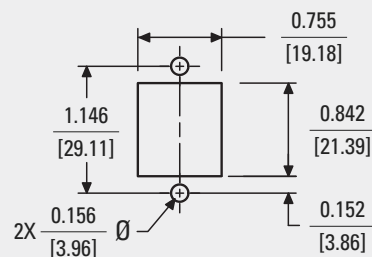

Panel Mounting Detail, Two Pole, One Handle

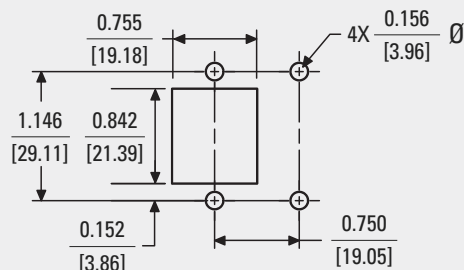

Panel Mounting Detail, Two Pole, Two Handles

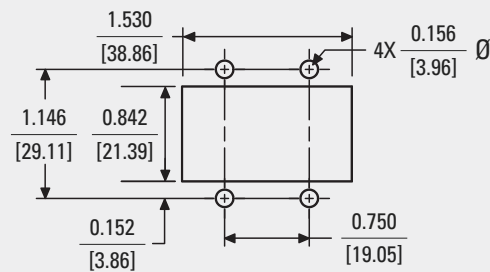

Single Pole

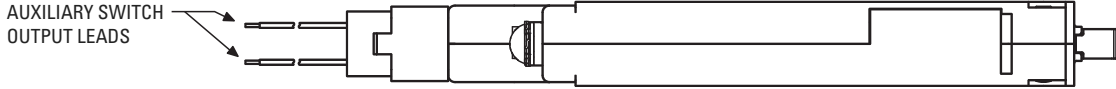

Two Pole (with or without 2nd handle)

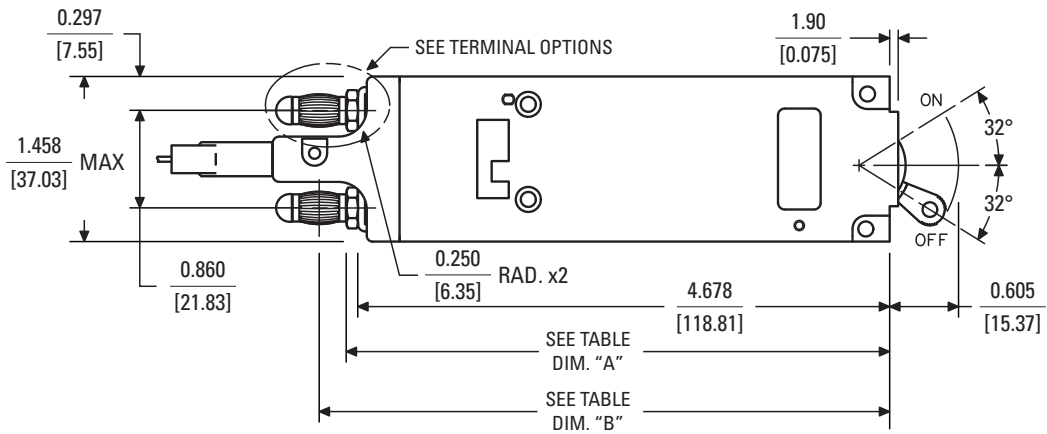
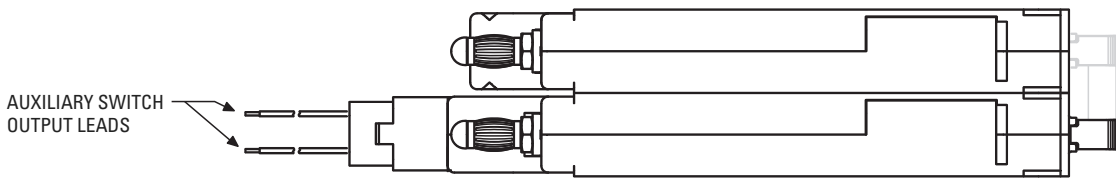

| DIMENSIONS | | | | | | |
|--------------|-------------------|-------------------|------------------------------------|-----------|------------------|------------------|
| Bullet Type | Dim. "A" | Dim. "B" | Dim. "C" | Stud Type | Dim. "E" | Dim. "F" |
| 1/4" Bullet | 4.778 [121.35] | 5.019 [127.48] | Ø 0.251 ± 0.001 Ø [6.38 ± 0.03] | 10-32 | 0.545 [13.84] | 0.622 [15.81] |
| 5/16" Bullet | 4.851 [123.22] | 5.092 [129.35] | Ø 0.312 ± 0.001 Ø [7.92 ± 0.03] | M5 | 0.510 [12.95] | 0.588 [14.92] |

**Single Pole Bullet Terminal
Mounting Detail**

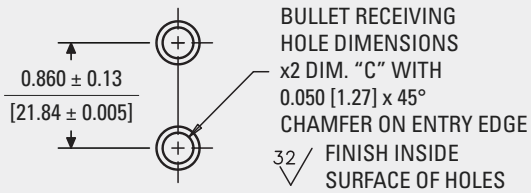

**Two Pole Bullet Terminal
Mounting Detail**

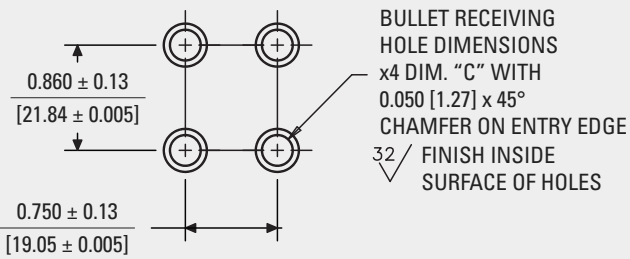

1/4" Bullet Terminals

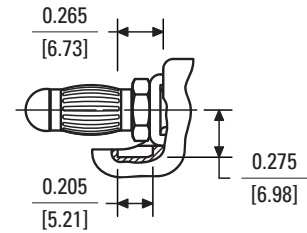

5/16" Bullet Terminals

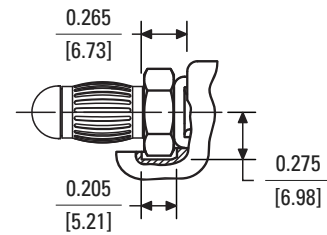

10-32 or M5 Screw Terminals

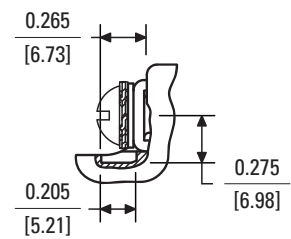

10-32 or M5 Stud Terminals

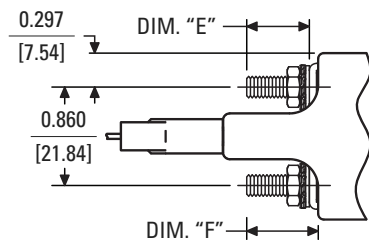

CONFIGURATIONS

Series Trip

The most popular configuration for magnetic protectors is the series trip where the sensing coil and the contacts are in series with the load being protected. In addition to providing conventional overcurrent protection, it is simultaneously used as an on-off switch.

Single Pole, Series Trip



Two Pole, Series Trip

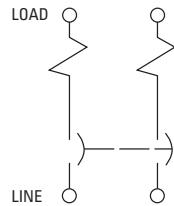

Mid-Trip

This is furnished as an integral part of a series pole in single or, multi-pole assemblies. Isolated electrically from the protector's circuit, the switch works in unison with the power contacts and provides indication at a remote location of the protector's ON-OFF status.

Mid-Trip

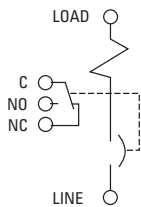

Breaker shown in ON position or manually turned OFF position

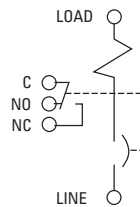

Breaker shown in mid-trip position (electrically tripped)

Auxiliary Switch

This is furnished as an integral part of a series pole in single or, multi-pole assemblies. Isolated electrically from the protector's circuit, the switch works in unison with the power contacts and provides indication at a remote location of the protector's ON-OFF status.

Auxiliary Switch

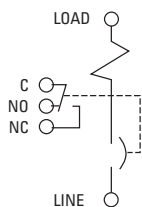

Breaker shown in OFF position

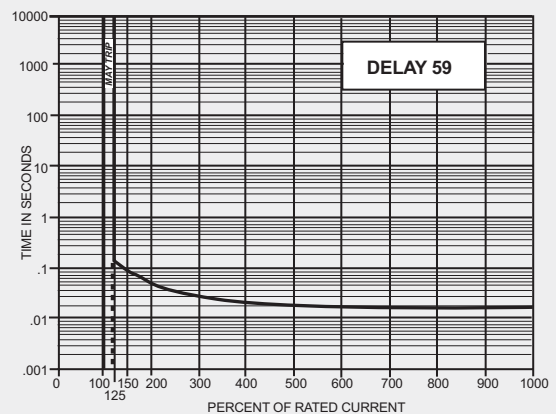
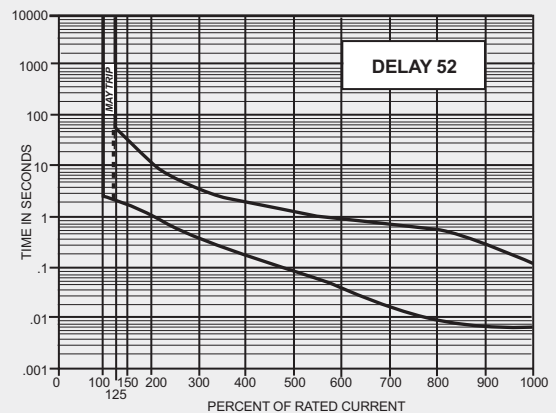
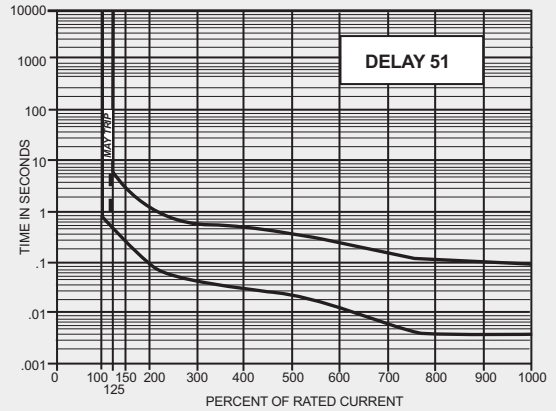

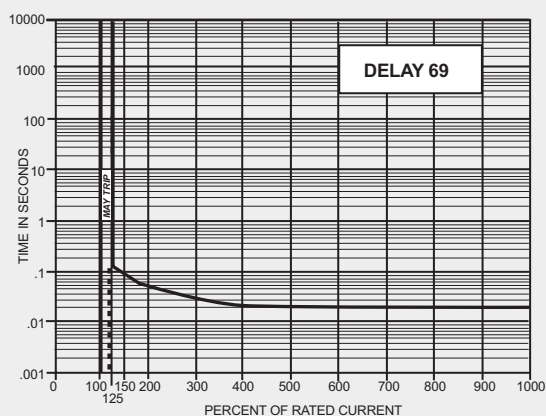
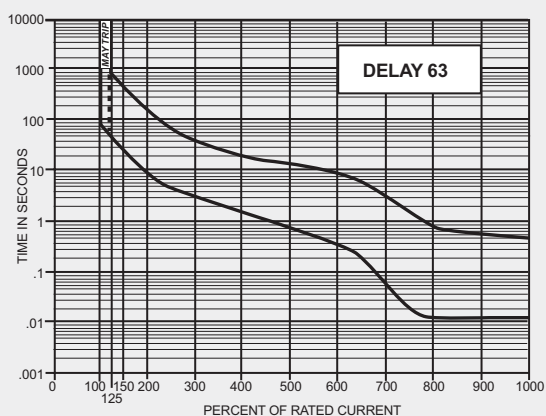
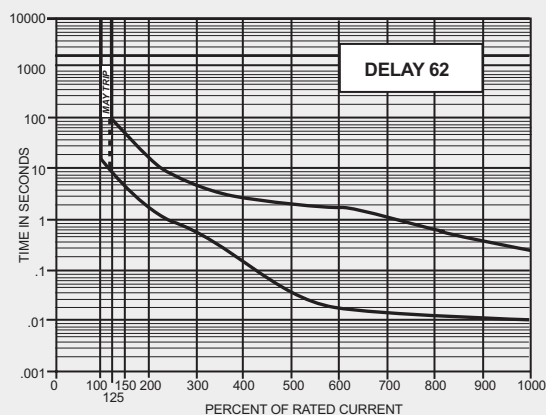
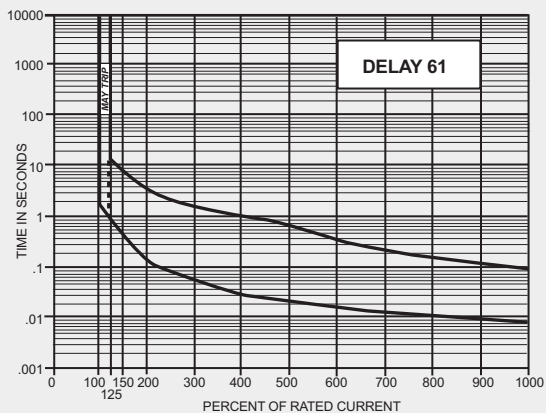

DELAY CURVES & SPECIFICATIONS

DC, 50/60Hz Delay Curves (typ)

A choice of delays is offered for DC and 50/60Hz applications. Delays 59 and 69 provide fast-acting, instantaneous trip and are often used to protect sensitive electronic equipment (not recommended where known inrush exists). Delays 51 and 61 have a short delay for general purpose applications. Delays 52 and 62 are long enough to start certain types of motors and most transformer and capacitor loads.

Trip Free

Will trip open on overload, even when forcibly held on. This prevents operator from damaging the circuit by holding handle in the ON position.

Trip Indication

The operating handle moves forcibly and positively to the OFF position on overload.

Ambient Operation

Operates normally in temperatures between -40°C and $+85^{\circ}\text{C}$.

Insulation Resistance

Not less than 100 megohms at 500Vdc.

Dielectric Strength

Shall withstand AC voltage 60 Hz, for 60 seconds between all electrically isolated terminals as described below.

| | |
|----------------------------|---|
| Series, switch only | : 3,750 VAC |
| Auxiliary switches | : 600 VAC |
| Series w/ auxiliary switch | : 3,750 between main circuit breaker terminal and auxiliary switch terminal |

Shock

Shall not trip when tested per MIL-STD-202, method 213, test condition 1 with 100% rated current applied to delayed units, except 90% current in plane 4, (i.e. handle down). Instantaneous units shall have 80% rated current applied in all planes.

Vibration

Shall not trip when vibrated per MIL-STD-202, method 204, test condition A with 100% rated current applied to delayed units and 80% rated current to instantaneous units.

Endurance

In many applications contact wear due to the electrical load determines unit life. At maximum electrical ratings, the IAR/IUR/IER/CUR/CER can perform 10,000 operations at rated current and voltage at a maximum rate of 6 operations per minute.

OPERATING CHARACTERISTICS

Inrush Pulse Tolerance

Many circuit protector applications involve a transformer turn-on, an incandescent lamp load, or a capacitor charge from a DC source. Each of these applications has one common factor: a steep transient of very high current amplitude and short duration. This takes the form of a spike or a single pulse and is the cause of most nuisance tripping associated with magnetic circuit breakers.

The IAR/IUR/IER/CUR/CER series will withstand, without tripping, a single pulse of 8 milliseconds duration (half sine wave configuration) and peak amplitude of 10 times its rating.

MAXIMUM DCR AND IMPEDANCE (APPROXIMATE VALUES)

| Current Ratings (Amps) | DC Resistance (Ohms) 51, 52, 53, 59 | 50/60Hz Impedance (Ohms) 61, 62, 63, 69 |
|------------------------|--|--|
| 2.0 | 0.027 | 0.038 |
| 3.0 | 0.074 | 0.098 |
| 5.0 | 0.037 | 0.048 |
| 7.5 | 0.025 | 0.029 |
| 15.0 | 0.010 | 0.011 |
| 32.0 | 0.003 | 0.003 |
| 40.0 | 0.003 | 0.003 |
| 50.0 | 0.0024 | 0.0025 |
| 65.0 | 0.0021 | — |

Tolerance: 2 to 2.5 amps ±20%; 2.6 to 20 amps ± 25%; 21 to 50 amps ±50%
**Consult factory for special values and for coil impedance of delays not shown*

AUXILIARY SWITCH RATING

| | | |
|-----------|---|----------------|
| 10.0 amps | @ | 250 VAC, 60 Hz |
| 3.0 amps | @ | 50 VDC |
| 1.0 amps | @ | 80 VDC |

APPROXIMATE WEIGHT PER POLE

| | |
|--------|-----------|
| 1 pole | 134 grams |
| 2 pole | 263 grams |

PULSE TOLERANCE

| Delay | Pulse Tolerance |
|------------|------------------------|
| 61, 62, 63 | 10 Times Rated Current |

PERCENTAGE OF RATED CURRENT VS TRIP TIME IN SECONDS AT +25°C (APPROXIMATE VALUES)

| Delay | 100% | 125% | 150% | 200% | 400% | 600% | 800% | 1000% |
|-------|---------|------------|-----------|------------|--------------|---------------|---------------|---------------|
| 51 | No Trip | 0.5 to 6.5 | 0.3 to 3 | 0.1 to 1.2 | 0.031 to 0.5 | 0.011 to 0.25 | 0.004 to 0.1 | 0.004 to 0.08 |
| 52 | No Trip | 2 to 60 | 1.8 to 30 | 1 to 10 | 0.15 to 2 | 0.015 to 1 | 0.008 to 0.5 | 0.006 to 0.1 |
| 59 | No Trip | 0.120 max | 0.1 max | 0.05 max | 0.022 max | 0.017 max | 0.017 max | 0.017 max |
| 61 | No Trip | 0.7 to 12 | 0.35 to 7 | 0.13 to 3 | 0.03 to 1 | 0.015 to 0.3 | 0.01 to 0.15 | 0.008 to 0.1 |
| 62 | No Trip | 10 to 120 | 6 to 60 | 2 to 20 | 0.2 to 3 | 0.015 to 2 | 0.015 to 0.8 | 0.01 to 0.25 |
| 63 | No Trip | 50 to 700 | 30 to 400 | 10 to 150 | 1.5 to 20 | 0.015 to 10 | 0.013 to 0.85 | 0.013 to 0.5 |
| 69 | No Trip | 0.12 max | 0.1 max | 0.05 max | 0.022 max | 0.017 max | 0.017 max | 0.017 max |

Barrier (-B)

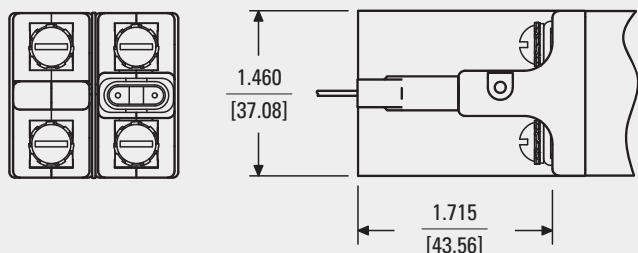

Bullets

Socket 1/4-20 UNC-2A
Order # 641-480-5032
(silver plated copper)

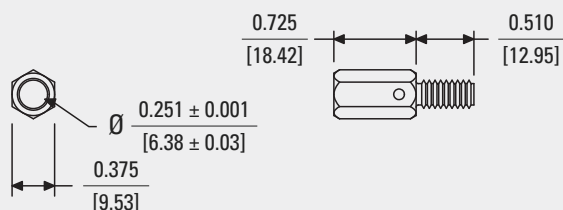

Socket 1/4-20 UNC-2A
Order # 641-480-5030
(silver plated copper)

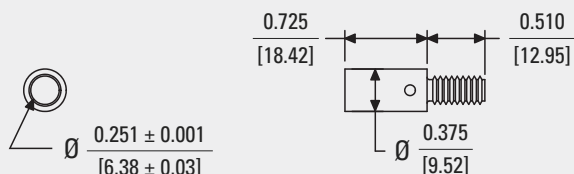

Socket 1/4-20 UNC-2A
Order # 641-480-5022
(silver plated copper)

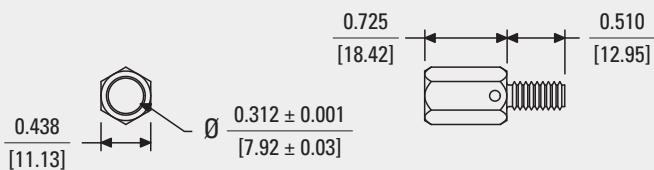

Nut 1/4-20 UNC-2B
Order # 388-899-5010
(silver plated copper)

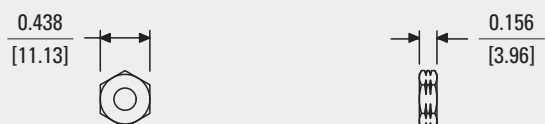

HARDWARE

Handle Lock

A handle lock option is available to prevent accidental actuation of the handle. The handle lock may be used in the ON or OFF position. Use of the handle lock on breakers with alarm style auxiliary switches may defeat the alarm feature on electrical trip. This option is available separately or pre-assembled (on single pole constructions only).

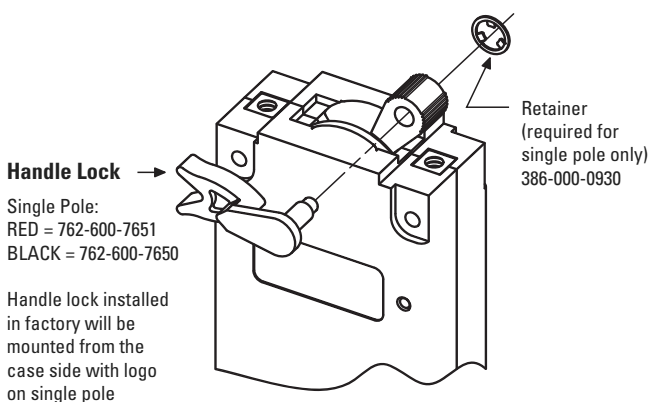

Mid-Trip

The handle position indicates the status of the circuit breaker. In addition to full ON and full OFF positions, there is a middle "MID-TRIP" position indicating that the breaker has electrically tripped from an overload. It is available in single pole and multi-pole (handle per pole only) series constructions. Switch only configuration is not available in mid-trip build. An auxiliary switch can be furnished as an integral part of the mid-trip breaker. The switch provides an indication at a remote location when the circuit breaker has electrically tripped and handle is in the mid-trip position.

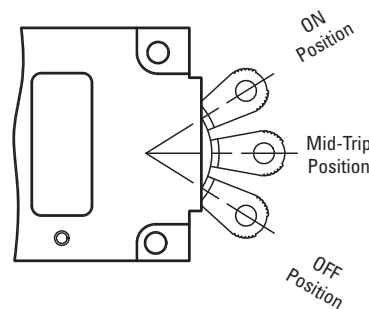

HOW TO ORDER

The ordering code for these circuit breakers / protectors may be determined by following the steps in the decision tables shown here.

The example shown is the code for a UL1077 & TÜV approved circuit protector with series trip, one handle per unit, single pole circuit protector with 10-32 terminal screws standard and a mechanical auxiliary switch. This unit is designed with a slow DC time delay and a rating of 20 amperes with optional metric threads and optional 80VDC capability. Handle color is black with white markings, and is has been met all the selection criteria to obtain the TÜV approval.

To determine the ordering code for your particular unit, simply follow the steps shown, then fill in the letters and/or numbers in the boxes. Space is available on the circuit breaker label for your part number (up to 12 digits). You may then use your own part number to place an order or as a reference for further questions you may have. This option does require a factory assigned part number for traceability to your drawing or internal part number.

| 1 | | |
|--------------------|---|---|
| First Choice: Type | | Second Choice: Terminal |
| IAR | Magnetic circuit protector, one handle per unit | 10-32 screw terminal, standard (no entry) |
| IARH | Magnetic circuit protector, one handle per pole | K 10-32 stud terminal |
| IER | UL1077 & TÜV, series trip, one handle per unit | B 0.250" bullet terminal |
| IERH | UL1077 & TÜV, series trip, one handle per pole | <p>The shaded areas denote TÜV approval options. This approval requires the addition of a "T" at the end of the part number (8th decision).</p> <p>The "T" will automatically be added to any part number formed entirely from these shaded decisions. If non-shaded areas are selected, the unit will not be TÜV approved, but other approvals (if applicable) will still apply.</p> |
| IUR | UL1077, series trip, one handle per unit | |
| IURH | UL1077, series trip, one handle per pole | |
| IMR | UL1077 & TÜV, mid trip, one handle per unit | |
| IMRH | UL1077 & TÜV, mid trip, one handle per pole | |
| CER | UL489A & TÜV, series trip, one handle per unit | |
| CERH | UL489A & TÜV, series trip, one handle per pole | |
| CUR | UL489A, series trip, one handle per unit | |
| CURH | UL489A, series trip, one handle per pole | |
| CMR | UL489A & TÜV, mid trip, one handle per unit | |
| CMRH | UL489A & TÜV, mid trip, one handle per pole | |

IER 1 - 1REC4C - 52 - 20.0 - AD - 01 - T



8
TÜV Approval

Per first decision's description: The shaded areas denote TÜV approval options. This approval requires the addition of a "T" at the end of the part number (8th decision).

2
Number of Poles

| | |
|----|-------------|
| 1 | Single pole |
| 11 | Two pole |

3
Internal Configuration

| | |
|---------|---|
| -1 | Series trip |
| -1REC4C | Mechanical trip auxiliary switch* |
| -1RS4C | Electrical trip auxiliary switch* |
| -1RLS4C | Electrical trip auxiliary switch* (mid-trip only) |
| -1REG4C | Series trip with auxiliary switch* 0.110 quick-connects (gold contacts) |
| -1REC40 | Mechanical trip auxiliary switch** |
| -1RS40 | Electrical trip auxiliary switch* |
| -1RLS40 | Electrical trip auxiliary switch* (mid-trip only) |
| -1REG40 | Series trip with auxiliary switch* 0.110 quick-connects (gold contacts) |

* Alarms when circuit breaker closes
** Alarms when circuit breaker opens

Only one auxiliary switch is normally supplied on two pole units. Switch is located in the right hand pole (viewed from terminal end) unless otherwise specified.

7
Handle Color & Markings

| | | | |
|-----|--------|-----|------------------------------------|
| -00 | Black | -01 | Black w/ white markings (standard) |
| -10 | Yellow | -11 | Yellow w/ black markings |
| -20 | Red | -21 | Red w/ white markings |
| -30 | Blue | -31 | Blue w/ white markings |
| -40 | Green | -41 | Green w / white markings |
| -60 | Orange | -61 | Orange w/ black markings |
| -90 | White | -91 | White w/ black markings |

6
Optional

| | |
|----|--|
| -A | Metric thread mounting (M3) & terminals (M5) |
| -B | Barrier (AC only) |
| -C | 65 VDC |
| -D | 80VDC |
| -E | 0.312" diameter bullet (standard is 0.250" when prefix with "B" is chosen in first decision) |
| -F | 250VAC |
| -L | Handle Lock |

Notes:
1. One or more descriptions may be used as required (for example, to get a barrier, 250VAC and handle lock, put -BFL)
2. When the sixth decision is not required, the seventh decision may be substituted and U.S. thread will be supplied

4
Frequency & Delay

| | |
|-----|---|
| -51 | DC short delay |
| -52 | DC long delay |
| -59 | DC 125% instant trip |
| -61 | 50 - 60 Hz short delay |
| -62 | 50 - 60 Hz Long Delay |
| -63 | 50 - 60 Hz motor start / extra long delay (30A max) |
| -69 | 50 - 60 Hz 125% instant trip |

5
Rated Current

Use three numbers to print required current value between 2.00 amps minimum and 50.0 amps maximum.

AIRPAX®

Snapak® Series Magnetic Circuit Protectors



Introduction • 55

Handles • 56

Configurations • 61

Operating Characteristics • 63

Delay Curves • 64

Specifications • 65

Hardware • 66

Decision Tables • 67

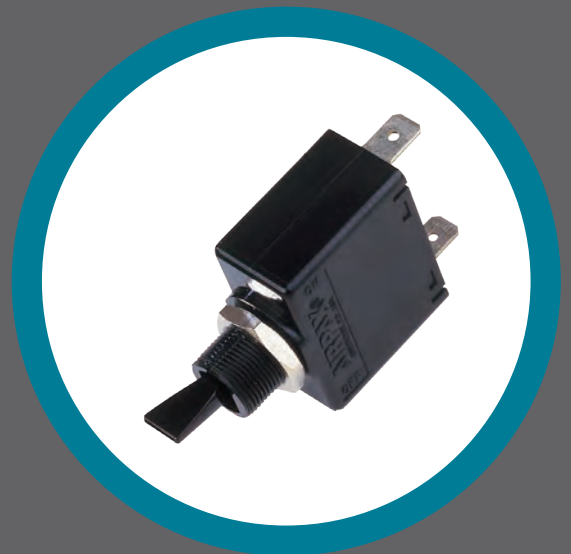



AIRPAX® | T/R/PP/PR/CR/PP/CPR Series Hydraulic Magnetic Circuit Protectors (SNAPAK®)

INTRODUCTION

The Airpax™ SNAPAK® series is a snap-acting hydraulic-magnetic circuit protector that combines power switching and accurate, reliable circuit protection in one aesthetically pleasing package. The SNAPAK® combines the functions of three separate components: power switch, fuse and fuse holder. To the OEM, this means that only one item has to be mounted instead of three. Less assembly is required, inventory is cut by two-thirds and greater panel density is obtainable with less clutter. In addition, the SNAPAK® can be operated at either DC or 50/60Hz, eliminating the need to specify, order and stock separate units. 400Hz units are also available.

To enhance front-panel aesthetics, SNAPAK® is offered with paddle and rocker handles in six attractive colors and push-pull and push-to-reset actuators. Also offered is a variety of optional mounting hardware. The push-pull version is supplied with a black button with a white indicating band.

Orientation of the button when marked with an amperage notation must be specified when using the fourth decision table. Push-to-reset is supplied with a contrasting color indicating shaft. In addition, SNAPAK® is offered in SPST and DPST configurations. The single pole satisfies most applications. The two-pole version is often used for extra safety in products that utilize high voltage or where current sensing and breaking of both sides of the line is required. Quick connect terminals are standard, UNC 8-32 or M4 screw terminals are available as additional termination options.

Since the SNAPAK® is snap-acting, it assures immediate opening and closing of the contacts. Its design also prevents operator “teasing” of the contacts and minimizes arcing. SNAPAK® circuit protectors are UL Recognized as supplementary protectors per UL STD. 1077, CSA Certified as supplementary protectors per CSA STD. C22.2 No. 235, VDE Approved as circuit breakers for equipment per STD. EN 60934, CCC Approved (customer must request product be manufactured in China) and CE Compliant. In addition, most versions are certified by UL to meet spacing requirements of IEC 950 for basic and functional insulation for front panel mounting.

Consult factory for details and exceptions. Typical applications include office appliances, electronic data processing, medical equipment, business machines, vending and amusement machines. Push-pull versions are particularly well suited for medical instrumentation, automotive production transfer lines and other applications where accidental turn off is unacceptable. For those applications which do not require circuit protection, SNAPAK® is offered in a power-switch-only configuration.

TOGGLE ACTUATORS

The SNAPAK® is available with paddle handles in six attractive colors. Engineered for safe, sure operation, the paddle handles may be specified in blue, white, red, green, yellow or black.

Mounting Details with Locking Ring

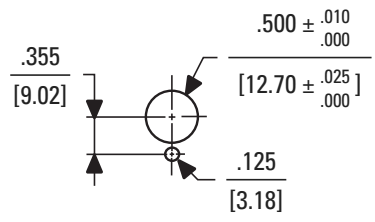

without Locking Ring

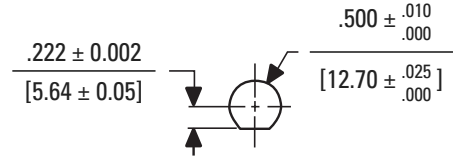

PANEL CUTOUT SHOWN ABOVE
MAY BE MADE WITH GREENLEE
RADIO CHASSIS PUNCH #733 x 1/2" DIA.

Note: Mounting Tolerance ± .005 [.13] unless noted angles: ±5°. Dimensions in Brackets [] are millimeters.

Single Pole, Toggle

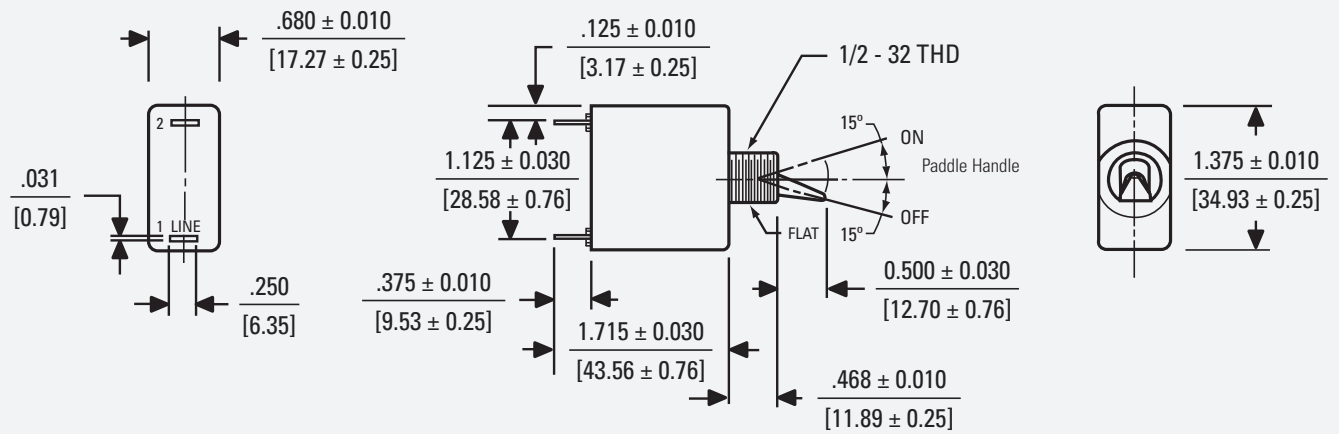

Two Pole, Toggle

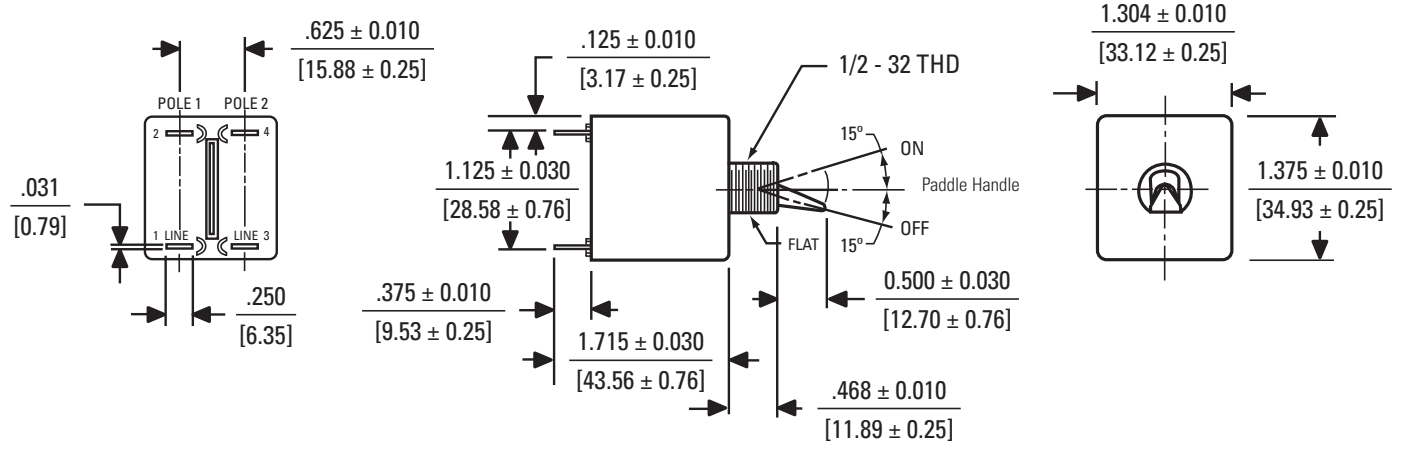

ROCKER HANDLES WITH ILLUMINATION

SNAPAKs are offered in single and two pole rocker styles in a choice of black, white or gray body colors. Handle color in non-illuminated types may be black, red, white or orange. Neon or light emitting diode (LED) illumination may be specified with a variety of options.

SNAPAK® circuit protectors with a second pole are available in paddle handle, push-pull, push-to-reset and rocker handle versions.

Mounting Detail

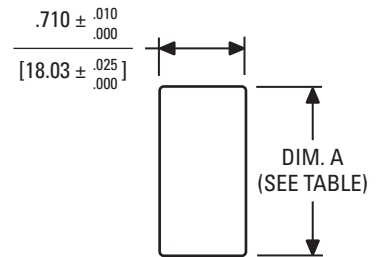

Rocker, Single Pole

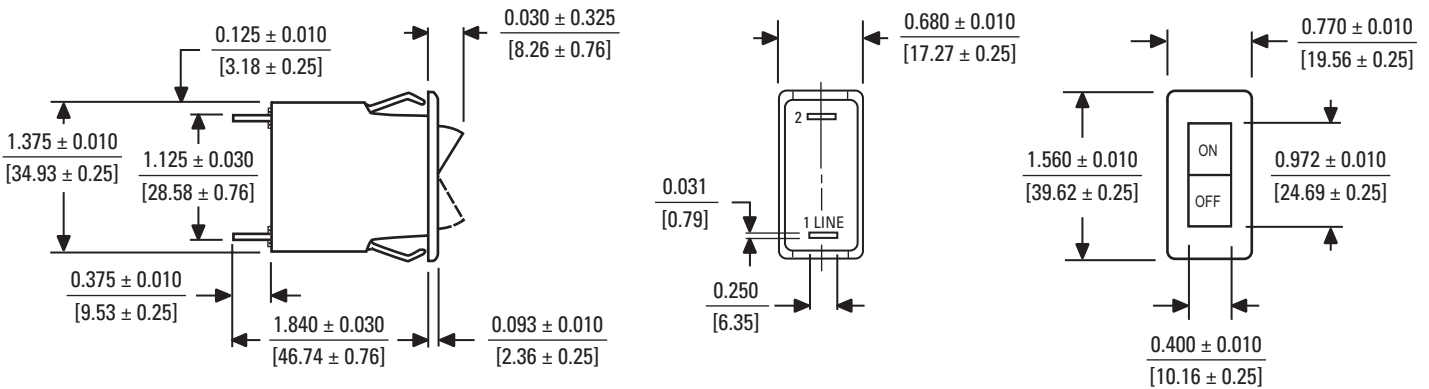

HANDLE GUARDS

The SNAPAK® circuit protector is available with an optional handle guard as an integrated part of the snap-in mounting design. Available for rocker actuators, the guard helps in providing protection from accidental "turn-off." Please refer to the SNAPAK® Part Number Decision Tables; fourth decision.

Handle Guards, Single Pole

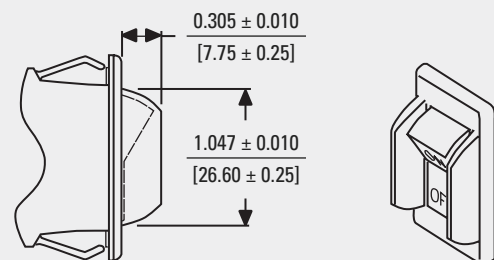

Handle Guards, Two Pole

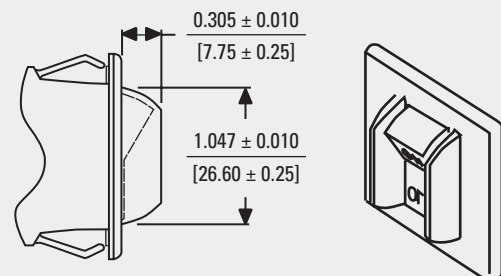

FRONT SNAP-IN MOUNT (STD)

| | | | |
|--|------------------|------------------|------------------|
| Panel Thickness | 0.125 [3.18] | 0.093 [2.36] | 0.062 [1.57] |
| Dimension "A" | 1.460 [37.08] | 1.420 [36.07] | 1.385 [35.18] |
| <i>Note: Tolerance for Mtg. ± .005 (.13)</i> | | | |

Mounting Detail

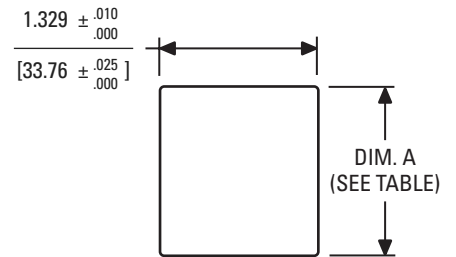

Rocker, Two Pole

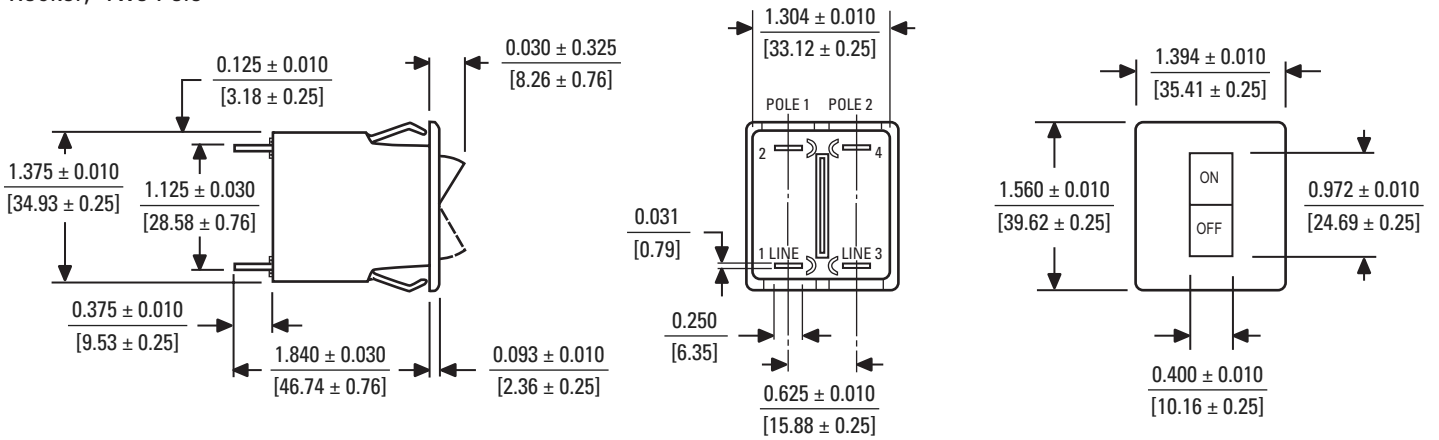

Illuminated Handle
Single Pole

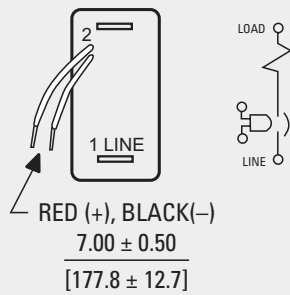

Two Pole

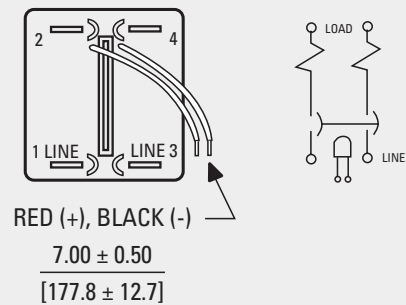

Note: Tolerance ± .005 [.13] unless noted angles: ±5°. Dimensions in Brackets [] are millimeters.

PUSH-PULL, PUSH-TO-RESET ACTUATOR

SNAPAK® may also be ordered with Push-Pull, or Push-to-Reset actuator buttons. As an option, the button can be embossed with the current rating (Push-Pull option only).

Push-Pull, Single Pole

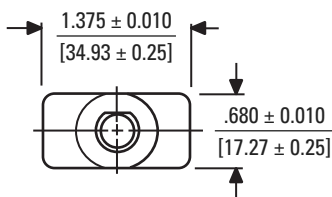
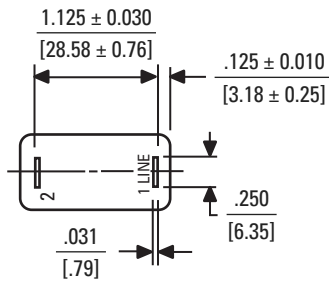
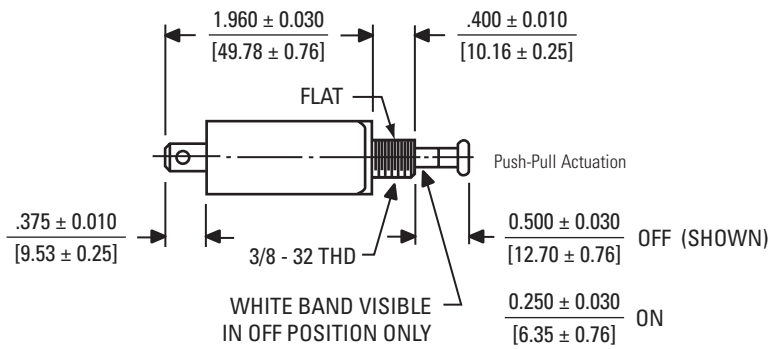

Mounting Detail
(Single Pole and Two Pole)

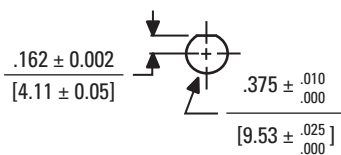

Note: Tolerance ± .005 [0.13] unless noted angles: ±5°. Dimensions in Brackets [] are millimeters.

Push-Pull, Two Pole

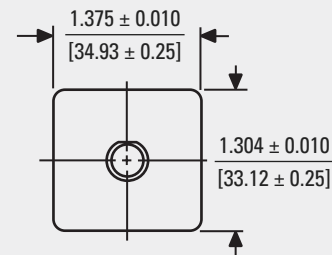
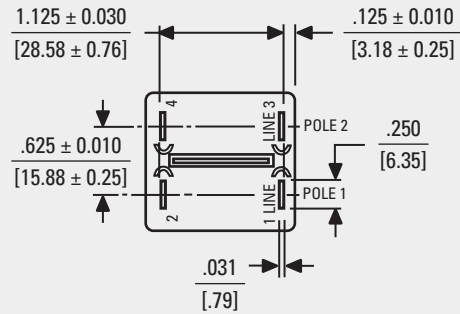
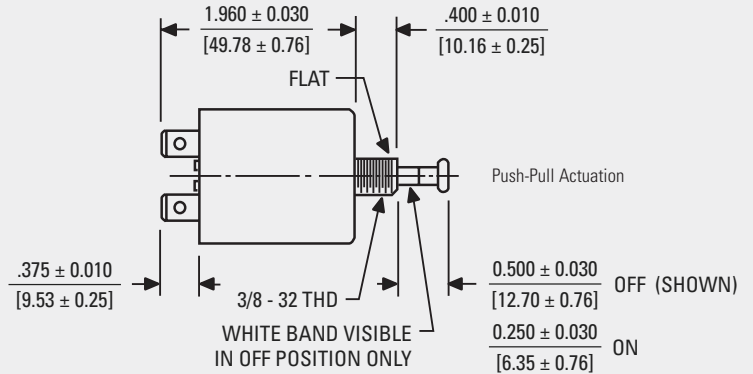

Push-to-Reset Actuation
(Single and Two Pole)

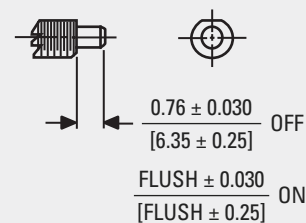

SCREW TERMINALS

Available as straight screw terminals with UNC 8-32 and Metric M4 screw types, bus-type connect (flat) or upturned lugs (tabs), with UL, CSA and TÜV approvals available. Screw terminals are available for all handle options (rocker, toggle, push-pull, push-to-reset). Single pole only, series only, non-auxiliary switch configurations.

| DIMENSION "A" | | |
|---------------|----------------|---------------|
| Handle Style | Screw Terminal | "A" Dimension |
| Toggle | Straight | 1.773 [45.03] |
| Push Button | Straight | 2.180 [55.37] |
| Rocker | Straight | 2.058 [52.27] |

Toggle

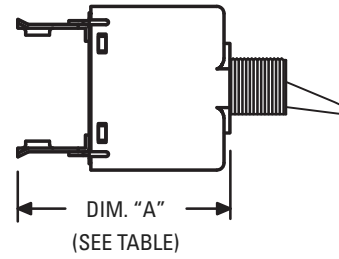

Push Button

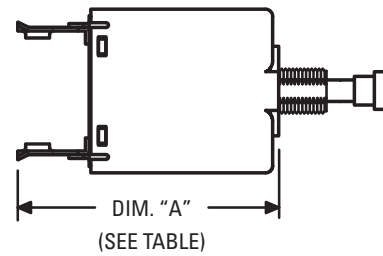

Rocker

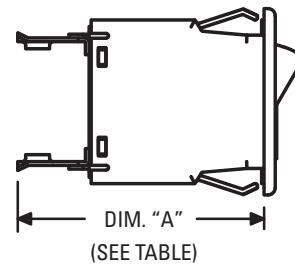

Straight

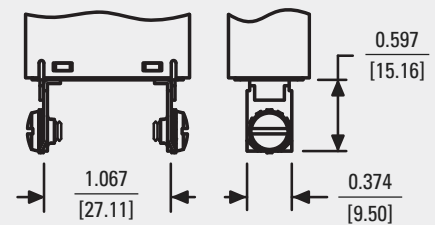

CONFIGURATIONS

Series Trip

The most popular configuration for magnetic protectors is the series trip where the sensing coil and the contacts are in series with the load being protected. In addition to providing conventional overcurrent protection, it is simultaneously used as an on-off switch.

Shunt Trip

The shunt trip is designed for controlling two separate loads with one assembly. The control is established by providing overload protection for the critical load. When the current through this load becomes excessive and reaches the trip point, the protector will open and remove power from both loads simultaneously. The current rating of both loads must not exceed the maximum contact rating.

Relay Trip

This permits the overload sensing coil to be placed in a circuit which is electrically isolated from the contacts. The coil may be actuated by sensors monitoring pressure, flow, temperature, speed, etc. Other typical applications include crowbar, interlock and emergency/rapid shutdown circuitry. Trip may be accomplished by voltage or current, which must be removed after trip.

Series Trip
Single Pole

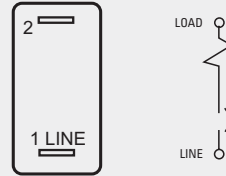

Two Pole

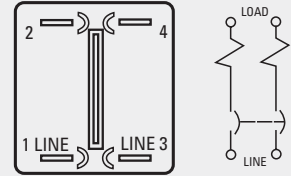

Shunt Trip
Single Pole

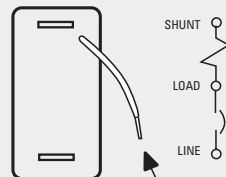

WHITE LEAD
 7.00 ± 0.50
[177.8 ± 12.7]

Two Pole
(1 pole shunt)

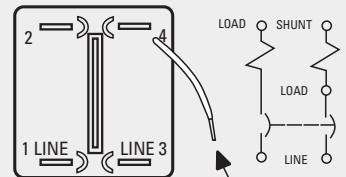

WHITE LEAD
 7.00 ± 0.50
[177.8 ± 12.7]

Relay Trip (Note A)
Single Pole

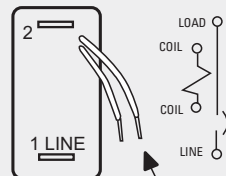

WHITE LEAD
 7.00 ± 0.50
[177.8 ± 12.7]

Two Pole
(1 pole relay)

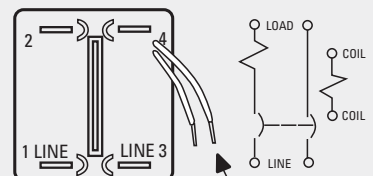

WHITE LEAD
 7.00 ± 0.50
[177.8 ± 12.7]

Note A: Coil Ratings to 5 amperes maximum. Contact ratings are 7.5 amperes at 50 Vdc and 250 Vac; 15 amperes at 120 Vac; 32 Vdc.

Note: Tolerance ± .005 [.13] unless noted.
Dimensions in Brackets [] are millimeters.

Auxiliary Switch

This is furnished as an integral part of a series pole in single or, multi-pole assemblies. Isolated electrically from the protectors circuit, the switch works in unison with the power contacts and provides indication at a remote location of the protector's ON-OFF status.

Voltage Trip

Sometimes called "dump circuits" or "panic trip circuits," these units make it possible to open main power contacts with lower power inputs from one or more sources. This configuration is becoming increasingly more important for sensitive circuitry and denser packaging in automation systems. Available in series, shunt or relay configurations.

Power Switch

In the event that over-current protection is not desired, the coil mechanism can be deleted, providing an excellent low cost single or double-pole power switch. Maximum current rating is 20 amps.

Auxiliary Switch (Note B) Single Pole



0.093 [2.36] 0.040 [1.02] DIA. HOLE (FOR SOLDER ATTACHMENT)

.100 to 20.0 amps,
NON-VDE &
NON-TÜV >20amps

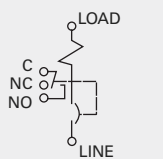

BREAKER SHOWN
IN OFF POSITION

VDE, TÜV >20amps
& U3 Construction

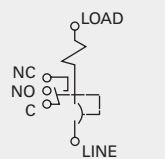

BREAKER SHOWN
IN OFF POSITION

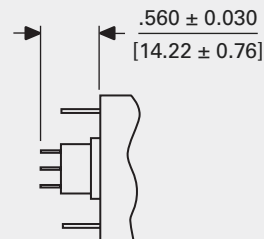

Auxiliary Switch (Note B) Two Pole

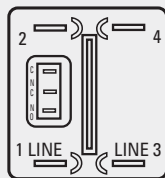

0.093 [2.36] 0.040 [1.02] DIA. HOLE (FOR SOLDER ATTACHMENT)

.100 to 20.0 amps,
NON-VDE &
NON-TÜV >20amps

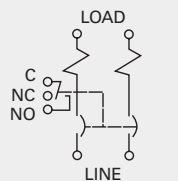

BREAKER SHOWN
IN OFF POSITION

VDE, TÜV >20amps
& U3 Construction

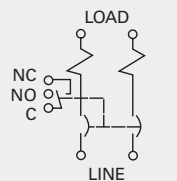

BREAKER SHOWN
IN OFF POSITION

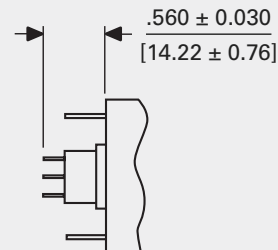

Note B: Switch is located in the left hand pole (viewed from terminal end).

OPERATING CHARACTERISTICS

Inrush Pulse Tolerance

Many circuit protector applications involve a transformer turn-on, an incandescent lamp load, or a capacitor charge from a DC source. Each of these applications has one common factor: a steep transient of very high current amplitude and short duration. This takes the form of a spike or a single pulse and is the cause of most nuisance tripping associated with magnetic circuit breakers.

SNAPAK® will withstand, without tripping, a single pulse of 8 milli-seconds duration (half sine wave configuration) and peak amplitude of 9 times its rating without the inertia wheel and 13 times its rating with an inertia wheel. (Not applicable to instant trip delays).

| MAXIMUM DCR AND IMPEDANCE | | | |
|---------------------------|-------------------------|-----------------------------|--------------------------|
| Current Ratings (Amps) | T/R/PP/PR DC Resistance | T/R/PP/PR 50/60Hz Impedance | CR/CPP/CPR DC Resistance |
| .100 | 175 | 181 | 274 |
| .500 | 6.34 | 6.63 | 9.77 |
| 1.00 | 1.63 | 1.69 | 2.31 |
| 2.00 | .400 | .425 | .465 |
| 3.00 | .175 | .188 | .261 |
| 4.00 | .103 | .106 | .156 |
| 5.00 | .076 | .078 | .091 |
| 7.50 | .038 | .039 | .053 |
| 10.0 | .026 | .028 | .023 |
| 12.5 | .020 | .021 | .020 |
| 15.0 | .013 | .014 | .010 |
| 20.0 | .010 | .011 | .008 |
| 25.0 | | | .004 |
| 30.0 | | | .003 |

DCR and Impedance is measured after 1 hour at 100% rated current using the Voltmeter-Ammeter Method.

| PULSE TOLERANCE | |
|-----------------|-------------------------|
| Delay | Pulse Tolerance |
| 1, 2, 61, 62 | *9 Times Rated Current |
| 3, 4, 61F, 62F | *13 Times Rated Current |

** Units above 15 amps are derated to 8 and 12 times rated current*

| PERCENTAGE OF RATED CURRENT VS TRIP TIME IN SECONDS AT +25°C (VERTICAL MOUNT) | | | | | | | |
|---|---------|----------|----------|----------|------------|-------------|--------------|
| Delay | 100% | 135% | 150% * | 200% | 400% | 600% | 800% |
| Instant | No Trip | May Trip | .100 Max | .100 Max | .100 Max | .100 Max | .100 Max |
| Fast | No Trip | .3 to 7 | .2 to 5 | .1 to 2 | .03 to .50 | .015 to .30 | .010 to .150 |
| Slow | No Trip | 3 to 70 | 2 to 40 | 1 to 15 | .10 to 4.0 | .015 to 2.0 | .010 to .800 |

** Minimum trip for all instantaneous and 400Hz units.*

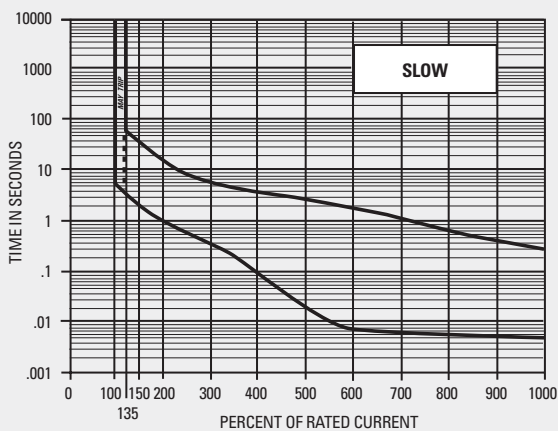
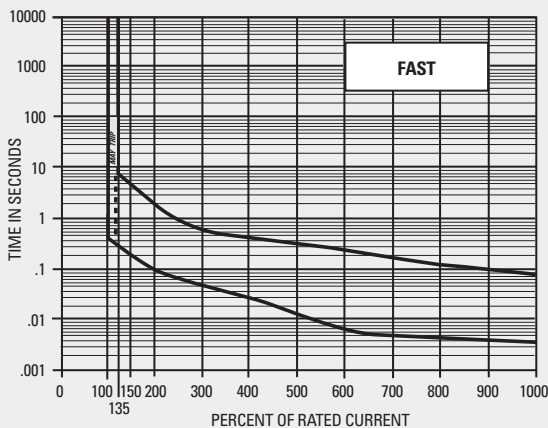
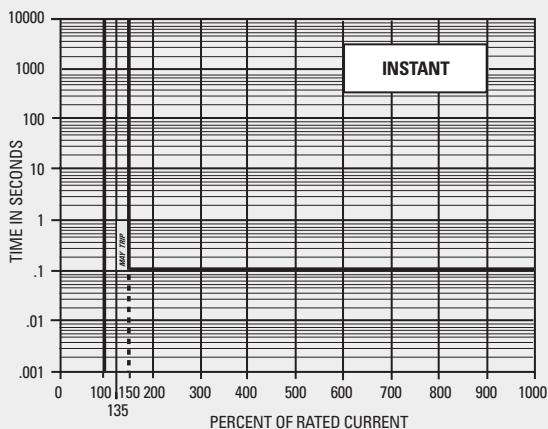

DELAY CURVES & SPECIFICATIONS

400 Hz, DC, 50/60Hz Delay Curves (typ)

A choice of delays is offered for DC, 50/60Hz and 400Hz applications. Delays 0, 49, 59 and 69 provide fast-acting, instantaneous trip and are often used to protect sensitive electronic equipment (not recommended where known inrush exists). Delays 1, 41, 51 and 61 have a short delay for general purpose applications. Delays 2, 42, 52 and 62 are long enough to start certain types of motors and most transformer and capacitor loads.

Trip Free

Will trip open on overload, even when forcibly held on. This prevents operator from damaging the circuit by holding handle in the ON position.

Trip Indication

The operating handle moves forcibly and positively to the OFF position on overload.

Ambient Operation

Operates normally in temperatures between -40°C and $+85^{\circ}\text{C}$.

Insulation Resistance

Not less than 100 megohms at 500Vdc.

Dielectric Strength

Withstands 1500 volts, 60Hz for 60 seconds or 1800Vac for one second between all electrically isolated terminals.

Endurance

Mechanical life in excess of 50,000 operations. In many applications, however, contact wear due to the electrical load determines unit life. At maximum electrical ratings, the SNAPAK® can perform 10,000 operations at rated current and voltage. Under UL 1077, the SNAPAK® can perform 50 operations at 150% of maximum rated current followed by 6,000 operations at maximum rated current. Under VDE 0642 (EN60934) the SNAPAK® can perform 6,000 electrical operations. After any endurance cycle, the breaker will calibrate and have working dielectric strength.

AGENCY APPROVALS (T/P/PP/PR SUPPLEMENTARY PROTECTORS)

| Voltage (Volts), Frequency (hz), Phase, Min Poles, TC, OL | | | | | | Current (Amps) | | Short Circuit Current Rating (Amps) | | Notes |
|---|----------------|-------|------------|----|----|----------------|---------|-------------------------------------|------|----------------|
| Voltage | Frequency (Hz) | Phase | Min. Poles | TC | OL | UL/CSA | VDE | UL 1077 & CSA | VDE | Notes |
| 32 | DC | - | 1 | 1 | 0 | .10-30(3) | .10-20 | U1, 1000 | 500 | |
| 38 | DC | - | 1 | 1 | 0 | .10-15 | - | U2, 1000 / U1, 1000 | - | PR only |
| 65 | DC | - | 1 | 1 | 0 | .10-7.5 | - | U2, 500 / U1, 500 | - | |
| 65 | DC | - | 2 | 1 | 0 | .10-15 | - | U1, 1000 | - | |
| 65 | DC | - | 2 | 1 | 0 | .10-20 | .10-20 | U2, 500 / U1, 500 | 500 | |
| 65(2) | DC | - | 1 | 1 | 0 | .10-30 | .10-30 | U2, 120 | 120 | R, PP, PR only |
| 65(2) | DC | - | 2 only | 1 | 0 | .10-25 | - | U1, 100 | - | R only |
| 65(2) | DC | - | 2 | 1 | 0 | .10-25 | - | U2, 500 | - | R only |
| 125 | 50/60 | 1 | 1 | 1 | 0 | .10-20 | 7.6-20 | U1, 1000 | 500 | |
| 125 | 50/60 | 1 | 1 | 1 | 0 | .10-30(3) | - | U1, 1000 | - | T only |
| 125(2) | 50/60 | 1 | 1 | 1 | 0 | .10-30 | - | U2, 1000 | - | R, PP, PR only |
| 125(2) | 50/60 | 1 | 1 | 1 | 1 | .10-30 | 20.1-30 | U3, 300(1) | 500 | R, PP, PR only |
| 120/240 | 50/60 | 1 | 2 | 2 | 0 | .10-20(3) | - | U2, 1000 | - | |
| 120/240 | 50/60 | 1 | 2 | 2 | 0 | .10-30(3) | - | U1, 650 | - | |
| 125/250 | 50/60 | 1 | 2 | 2 | 0 | .10-20 | - | U1, 1000 | - | |
| 250 | 50/60 | 1 | 1 | 2 | 0 | .10-20 | .1-7.5 | U1, 500 | 500 | |
| 250 | 50/60 | 1 | 1 | 1 | 0 | .10-7.5 | - | C1, 1000(4) | - | |
| 250 | 50/60 | 1 | 2 | 2 | 0 | .10-20 | .10-20 | U1, 1000 | 500 | |
| 250(2) | 50/60 | 1 | 2 | 1 | 1 | .10-30 | - | U3, 300 | - | R only |
| 125 | 400 | 1 | 1 | 2 | 0 | .10-20 | - | U1, 1000 | - | |
| 125/250 | 400 | 1 | 2 | 2 | 0 | .10-20 | - | U1, 1000 | - | |
| 250 | 400 | 1 | 2 | 2 | 0 | .10-20 | - | U1, 1000 | - | |
| 250 | 400 | 1 | 1 | 2 | 0 | .10-7.5 | - | U1, 1000 | - | |
| CR/CPP/CPR COMMUNICATIONS EQUIPMENT CIRCUIT BREAKERS | | | | | | | | | | |
| 65 | DC | - | 1 only | - | - | .10-30 | .10-30 | 1000 | 1000 | |
| 80 | DC | - | 1 only | - | - | .10-30 | .10-30 | 600 | 600 | |

(1) Non-standard construction. "Fit For Further Use" approval; (2) Non-snap action design; (3) No auxiliary switch available above 20A; (4) With 30A max. series fuse

General notes:

All supplementary protectors are of the overcurrent (OC) type
 The family of protectors has been evaluated for end use application for use group (UG) A
 The terminals (FW) are suitable for factory wiring only (O)
 The maximum voltage ratings for which the protectors have been tested are shown in the chart
 The current is the amperage range that the protectors have been tested
 The tripping current (TC) for the protectors is either "1" (in the range of 125% to 135% of ampere rating) or "2" (more than 135% of ampere rating)
 The overload rating (OL) – designates whether the protector has been tested for general use or motor starting applications.
 0 – tested at 1.5 times amp rating for general use
 1 – tested at 6 times AC rating or 10 times DC rating for motor starting
 The short circuit current rating (SC) – The short circuit rating in amperes following a letter and number designating the test conditions and any calibration following the short circuit test is defined below:

| AUXILIARY SWITCH RATING | | | |
|-------------------------|---|---------|--------|
| Silver | | | |
| 3.0 amps | @ | 120 VAC | — |
| 1.5 amps | @ | — | 32 VDC |
| Gold | | | |
| .100 amps | @ | 32 VAC | 32VDC |

| APPROXIMATE WEIGHT PER POLE | | |
|-----------------------------|--------|-------|
| | Ounces | Grams |
| Rocker Configuration | 0.9 | 25 |
| Toggle, PP, PR | 1.2 | 32 |

C – Indicates short circuit test was conducted with series overcurrent protection
 U – Indicates short circuit test was conducted without series overcurrent protection
 1 – Indicates a recalibration was not conducted as part of the short circuit testing
 2 – Indicates a recalibration was performed as part of the short circuit testing
 3 – Indicates recalibration was performed along with the dielectric and voltage withstand for "Suitable for Further Use" rating

Short Circuit Interrupting Capacity

1000 amperes maximum for UL and CSA, 500 amperes maximum for VDE. Consult factory for details.

Handle and Body Material

The handle and upper body material is polycarbonate and the lower body is PET.

Chemical Resistance

Handle and case may be cleaned with detergents or alcohols and should be restricted to outside surfaces only. Organic solvents are not recommended. Special attention should be given when solvents are used to remove excess flux from terminals. No oils or lubricants should be introduced into handle openings or onto bushing threads.

IEC, UL, CSA, SEV, VDE, CCC, CE, TÜV

Recognized by UL to STD-1077 and UL certified to spacing requirements of IEC 950 for basic and functional insulation for front panel mounting. Certified by CSA, file number LR26229 as recognized supplementary protectors, SEV approved, CCC approved, TÜV approved (including screw terminals) and VDE approved to VDE 0642. VDE approval of unmarked rocker handle option for appliance disconnect requires status of protectors to be indicated on the panel. Only VDE approved part numbers will be marked CE compliant. See shaded areas of part number decision tables for approved configurations and/or consult factory for exceptions and limitations.

Shock

Withstands 75G without tripping while carrying full rated current per MIL-STD-202, Method 213, Test Condition I. Instant trip breakers are tested at 80% of rated current.

Vibration

Time delayed units withstand 10G without tripping while carrying full rated current per MIL-STD-202, Method 204, Test Condition A. Instant trip breakers are tested at 80% of rated current.

UL 489A Listed

The CR, CPP and CPR are dimensionally the same as the popular R, PP and PR Snapack products, but provide UL listing to UL489A for Communications Equipment. Available only in single pole with DC trip time delays for series or series with silver auxiliary switch configurations. As a circuit breaker, the CR, CPP or CPR provides communication equipment manufacturers with a UL listed circuit breaker in an extremely compact package that meets the stringent environmental requirements of today's marketplace. This makes the CR, CPP and CPR ideal for switching, transmission and wireless applications.

Paddle Handle Hardware



- A

Vertical Mount

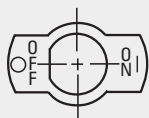

- B

Horizontal Mount

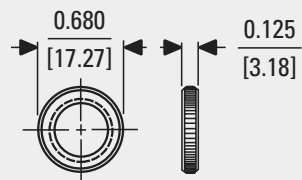

- 10 & -11

Knurled Nut

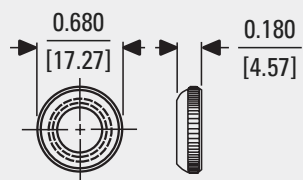

- 20 & -21

Panel Dress Nut

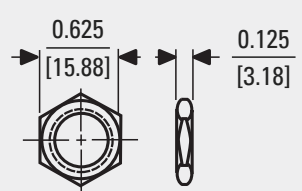

- 31

Hex Nut

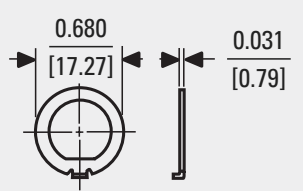

- L

Locking Ring (Toggle)

Push-Pull & Push-to-Reset Hardware

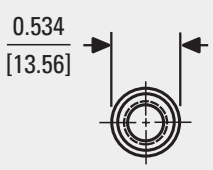

3/8 - 32 Panel Nut
Bright Nickel

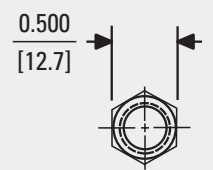
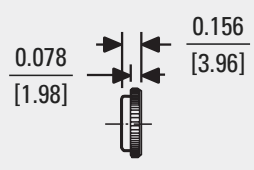

3/8 - 32 Hex Nut
Bright Nickel

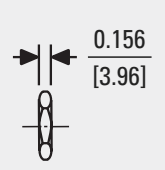

Note: Tolerance ± .010 [.25] unless noted. Dimensions in brackets [] are millimeters.

HARDWARE

Indicator Plates

SNAPAK® toggle handle circuit protectors may be specified with indicator plates for either vertical or horizontal mounting. The "ON-OFF/O-I" plate is standard.

Note 1:

To allow for installation clearances, the minimum recommended distances between centers of panel openings should be:

| RECOMMENDED CENTER DISTANCES FOR PANEL OPENINGS | |
|---|-----------------------|
| Breaker Type | Distance, inches [mm] |
| T11 | 0.750 [19.05] |
| T21 | 1.375 [34.93] |
| PP11 & PR11 | 0.750 [19.05] |
| PP21 & PR21 | 1.375 [34.93] |
| R11 | 0.805 [20.45] |
| R21 | 1.429 [36.30] |

Note 2: Torque on mounting hardware is not to exceed 25 inch-pounds for 1/2 inch bushings or 15 inch-pounds for 3/8 inch bushings.

Mounting Nuts (Toggle)

A choice of knurled, dress and hex nuts are available. All three are available in bright nickel. The knurled and dress nuts are also available in a matte black finish. Every SNAPAK® comes with a hex nut, but you may order the front panel nuts which will best enhance your design.

Miscellaneous Hardware

SNAPAK® circuit protectors with 1/2-32 thread may also be equipped with optional locking rings to prevent rotation of the unit after it is installed.

3/8 - 32 Hex Nut and Panel Nuts

The hardware will be supplied with each Push-Pull (PP) and Push-to-Reset (PR).

3/8 - 32 Panel Nut

This nut when reversed will provide alignment in .437 (11.1) and .468 (11.88) diameter round panel holes.

HOW TO ORDER

The ordering code for the SNAPAK® circuit protectors may be determined by following the steps in the decision tables shown here.

The coding given permits a self-assigning part number, with certain limitations (due to the adaptability of magnetic protectors to complex circuits), requires a factory-assigned part number.

The example shown is the code for a paddle handle, single pole (UL construction), series circuit protector designed for operation of a 50/60Hz/DC circuit. A slow time delay and rating of 5 amperes has been indicated. Handle color is black, and a bright nickel knurled nut, vertical mount (ON-OFF) indicator plate and locking ring are to be supplied.

To determine the ordering code for your particular SNAPAK® unit, simply follow the steps shown, then fill in the letters and/or numbers in the boxes. Space is available on the circuit breaker label for your part number (up to 12 digits). You may then use your own part number to place an order or as a reference for further questions you may have. This option does require a factory assigned part number for traceability to your drawing or internal part number.

| 1 First Decision | | | | | |
|------------------|---------------|-------------------------|---|--|--|
| Handle | Poles | Configurations* | Terminals | | |
| T | Paddle Handle | 1 Single Pole † | 0 Switch Only (Note E) | Quick Connects (leave blank) | |
| PP | Push-Pull | 4 Single Pole †† | 1 Series Circuit Protector | S Screw Terminals, Single pole (-1) and series only (5th decision, group V - screw terminal option is required when 1st decision "S" is specified) | |
| PR | Push-To-Reset | 2 Two Pole † | 3 Shunt Circuit Protector | | |
| R | Rocker | 5 Two Pole †† | 4 Relay Circuit Protector †††† | | |
| CR | Rocker | ** | 5 Series w/ Silver Aux. Switch ††† | | |
| CPP | Push-Pull | ** | 6 Series w/ Gold Aux. Switch ††† | | |
| CPR | Push to Reset | ** | 9 Mixed Construction (2 Pole Only) | | |

† UL & CSA Construction
 †† Non UL & CSA Construction
 ††† Auxiliary Switch is located in the left hand pole (viewed from terminal end)
 †††† Does not meet spacings for many IEC /VDE equipment specs. Consult factory for additional information.
 * Multi-pole units with mixed construction, poles numbered left to right when viewed from terminal end. Shunt or relay construction available in pole 2 only, other pole must be a series or switch only construction.
 **UL 489A listed, available in 1 pole series or series w/silver aux. switch. DC delay only

T11 - 2- 5.00A - 01-11AL- V

| 2 Second Decision | |
|-------------------|-----------------------------------|
| Frequency & Delay | |
| -0 | Instant DC-50/60 Hz |
| -1 | Fast DC-50/60 Hz |
| -2 | Slow DC-50/60 Hz |
| -3 | Fast w/ Inertia Wheel DC-50/60 Hz |
| -4 | Slow w/ Inertia Wheel DC-50/60 Hz |
| -41* | Fast 400 Hz*** |
| -42* | Slow 400 Hz* |
| -49* | Instant 400 Hz |
| -51 | Fast DC+ |
| -52 | Slow DC+ |
| -59 | Instant DC+ |
| -61 | Fast 50/60 Hz* |
| -62 | Slow 50/60 Hz* |
| -69 | Instant 50/60 Hz |
| -S | Switch Pole or Special Delay |

* 20 amps max for 400Hz
 **For addition of Inertia Delay an "F" may be added to delay 41, 42, 51, 52, 61, 62 only
 †CR, CPP, CPR only available in these delays

| 3 Third Decision | |
|---|------------------------|
| Rated Current | |
| Circuit Breaker Construction | |
| Use three numbers to print required current value between .100 amps minimum and 30.0 amps maximum. | |
| For example, use: .100 or 2.00 or 10.0 | |
| Switch Only Construction | |
| -SW | Maintained SPST & DPST |
| Note: 20.0 amps max for 400 Hz units. | |

Notes:

- A A neon bulb is provided when specified for 120Vac and 250Vac operation. For operation at 120Vac a 33,000 ohm, 1/2 watt external resistor is required. At 250Vac a 100,000 ohm, 1 watt external resistor is required.
- B An LED with 750 ft. L @ 20mA is provided in the center of the handle. Maximum power dissipation @ 25°C is 135mW. Continuous forward current is 20mA. Forward voltage, typical, is 1.6v at 20mA. Reverse current, typical, is 100mA @ 3.0 volts. An external resistor may be required to limit current to these values.
- C When ordering Paddle Handles, you may choose one item from each hardware group to add to 5th decision if such items are desired. For example, "-11ALCA" would indicate a bright nickel knurled nut, plus a vertical mount indicator, plus a locking ring, plus #8-32 screw terminal, straight with tabs.
- D All units except Rocker units will have (1) hex nut installed as standard hardware for the back of a panel. The choices in the fifth decision table are intended for the front or visible side of the panel and are offered for Paddle Handle configuration only. Push-Pull and Push-to-Reset configurations include one (1) panel nut and one (1) hex nut as standard hardware.
- E Switch only — no current overload protection provided.
- F CCC Approval - If CCC is required on this product, please inform Sensata to have this product manufactured in our China facility

4 Fourth Decision

| | | | |
|---|-------|----------|-----------------------|
| Rocker | | | |
| Step 1: Choose Letter For Body Color | | | |
| B | Black | R | Black w/ Handle guard |
| G | Gray | S | Gray w/ Handle guard |
| W | White | T | White w/ Handle guard |
| Example: "W..." For White Rocker Body (Rocker Style) | | | |

| | | | |
|--|--------|-----------------|--|
| Step 2: Choose Handle Combinations | | | |
| Without Illumination Basic Handle Color (w/o Markings) | | | |
| 01 | Black | Example: "-W06" | |
| 02 | Red | | |
| 06 | White | | |
| 07 | Orange | | |

| | | | |
|---|---|--|--|
| With Illumination Basic Handle Color & Light Choice (w/o Markings) | | | |
| 101 | Clear w/Neon (Note A) | | |
| 102 | Clear w/Green Glow Neon (Note A) | | |
| 103 | Clear w/Red LED (Note B) | | |
| 104 | Clear w/4-8 Vdc Red LED | | |
| 105 | Clear w/8-16 Vdc Red LED | | |
| 107 | Clear w/Green LED (Note B) | | |
| 108 | Clear w/4-8 Vdc Green LED | | |
| 109 | Clear w/8-16 Vdc Green LED | | |
| 121 | Transparent Red w/Neon (Note A) | | |
| 123 | Transparent Red w/Red LED (Note B) | | |
| 124 | Transparent Red w/Red LED 4-8 Vdc | | |
| 125 | Transparent Red w/Red LED 8-16 Vdc | | |
| 161 | Translucent White w/Neon (Note A) | | |
| 162 | Translucent White w/ Green Glow Neon (Note A) | | |
| 171 | Transparent Amber w/Neon (Note A) | | |
| 181 | Transparent Smoke Gray w/Neon (Note A) | | |
| 182 | Transparent Smoke Gray w/Green Glow Neon (Note A) | | |
| 183 | Transparent Smoke Gray w/Red LED (Note B) | | |
| 184 | Transparent Smoke Gray w/4-8 Vdc Red LED | | |
| 185 | Transparent Smoke Gray w/8-16 Vdc Red LED | | |
| 187 | Transparent Smoke Gray w/Green LED (Note B) | | |
| 188 | Transparent Smoke Gray w/4-8 Vdc Green LED | | |
| 189 | Transparent Smoke Gray w/8-16 Vdc Green LED | | |
| Example: "-W124" | | | |
| If you prefer NO markings, then your handle decision is now complete. | | | |

Step 3: Choose Handle Markings

Marked For Vertical Mount-After choice of 3 digit number in step 2 above.

| | | |
|---------------------------------|--|------------------------------|
| | | |
| Add "CV" for Combined markings. | Add "EV" for English markings. Example: "-W124EV" | Add "IV" for Intl. markings. |

Marked For Horizontal Mount-After choice of 3 digit number in step 2 above.

| | | |
|---------------------------------|--|--------------------------------------|
| | | |
| Add "CH" for Combined markings. | Add "EH" for English markings. Example "-W06EH" | Add "IH" for International markings. |

If you have chosen a handle from this table, your 4th Decision and your catalog part number are now complete (except if you require "-S" screw terminal option from the 5th Decision Table.)

| | |
|-------------------------|--------|
| Paddle (T) Handle Color | |
| -01 | Black |
| -02 | Red |
| -03 | Yellow |
| -04 | Green |
| -05 | Blue |
| -06 | White |

If you have chosen a handle from this table, your 4th Decision is now complete except for hardware options in 5th Decision Table.

| | | | | |
|-----------------------------|--|--|-----|------|
| Push-Pull (PP, CPP and CPR) | | | | |
| -XX | No Button Markings desired (not available for CPP & CPR) | | | |
| -OA | | Marked Buttons Available For These Amperages | | |
| -OB | | 0.1 | 1 | 10 |
| | | .25 | 2.5 | 15 |
| -OC | | 0.5 | 5 | 17.5 |
| | | .75 | 7.5 | 20 |

If you have chosen a handle from this table, your 4th Decision & your catalog PN are now complete (except if you require "-S" screw terminal option from the 5th Decision Table.)

| | |
|--------------------|-------------------------|
| Push-to-Reset (PR) | |
| -XX | No Button Markings Only |

If you have chosen a handle from this table, your 4th Decision and your catalog PN are now complete (except if you require "-S" screw terminal option from the 5th Decision Table.)

5 Fifth Decision

Hardware & Accessories (Notes C and D)

| Group I | | Group II (Indicator Plate) | | Group V (Screw Terminal Options) | |
|------------|-------------------------------|--|---|---|--|
| -00 | No Outer Hardware Desired | -A | Vertical Mount (Off/On & O/I)* | -C | SAE 8-32, Upturned Lugs (Tabs) Straight Terminal |
| -10 | Black Knurled Nut | | | | -F |
| -11 | Bright Nickel Knurled Nut | | | -D | |
| -20 | Black Panel Dress Nut | -H | M4, Bus-Type Connect (Flat) Straight Terminal | | |
| -21 | Bright Nickel Panel Dress Nut | | | | |
| -31 | Bright Nickel Hex Nut | -B | Horizontal Mount (Off/On & O/I)* | | |
| Group III | | *Selection of A or B Indicator Plate required for VDE and CCC. | | Please select a screw terminal option if you selected "S" in Decision 1 | |
| -L | Locking Ring | | | | |

V = VDE, TÜV and CCC Approved

T = TÜV Approved

The shaded areas denote VDE, CCC (if applicable) and CE compliant options. The V will be added to any part number formed entirely from shaded decisions. If non-shaded areas are selected, the unit will not be VDE approved, nor CE compliant, but other approvals still apply. 20 amps max rating on VDE units.

This approval requires the addition of a T at the end of the PN. The unit will not be VDE approved. If non-shaded areas are selected, the unit will not be TÜV approved, with the exception being you can select screw terminals and screw terminal options (1st & 5th decision) as these options are TÜV approved.

AIRPAX®

AP/UP, AP/MIL Series Magnetic Circuit Protectors

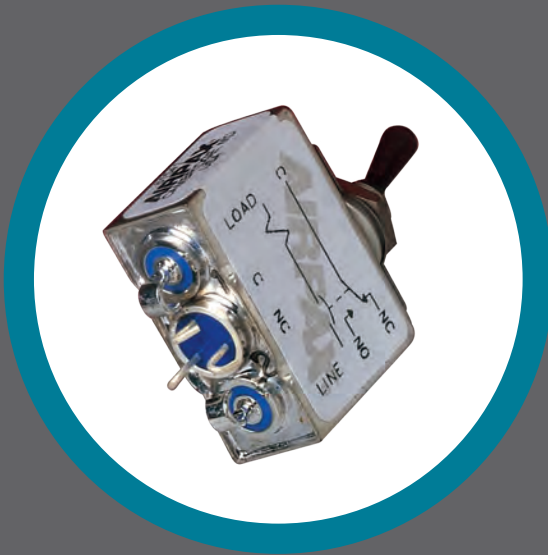

Introduction • 71

Poles • 72

Configurations • 75

Operating Characteristics • 76

Delay Curves • 77

Specifications • 78

Decision Tables • 79





AIRPAX® | AP/UP, AP/MIL Series Hydraulic Magnetic Circuit Protectors

INTRODUCTION

The Airpax™ AP series are fully sealed, magnetic circuit protectors that combine power switching and accurate, reliable circuit protection with inverse time delays and trip free features.

Unlike a thermal circuit protector, the AP does not change its trip current over a wide temperature span. In addition, the AP magnetic circuit protector is available in either DC, 50/60Hz or 400Hz versions and with various delays to match the protector to specific application requirements.

One of the most important features of this protector is the “trip free” action, which means the circuit will not remain closed in the presence of an overload even though the handle is held in the ON position. The delay mechanism senses the fault and the contacts open.

Waterproof panel integrity is provided by an “O” ring bushing seal and a silicon rubber gland within the bushing/handle assembly. Salt spray testing per MIL-STD-202, Method 101, Test Condition B, with no evidence of corrosion, electrical or mechanical damage.

Typical applications include communication, navigation and aircraft instrumentation, radar and power supplies.

The Airpax™ UP circuit protector, with UL recognition and CSA certification, is essentially the same as the AP in construction and operating principle. It is approved for operation at 50 volts DC to 20 amperes, 120 volts 50/60Hz to 15 amperes and 240 volts 50/60Hz to 7.5 amperes. The UP circuit protector is available in single pole units only, due to UL and CSA creepage specifications and the wide glass terminals utilized. The UP series offers an optional FM approval (Factory Mutual Research), provided for petrochemical applications. FM approval is available for single pole, series trip, UP type units only.

The Airpax™ AP-MIL protectors are produced in accordance with MIL-PRF-39019 and the pertinent specification sheets, are subjected to an exacting production and test program to maintain their Qualified Products Listing (QPL). One, two and three pole series trip units, with or without auxiliary contacts, have been accepted for this listing. Refer to specification sheets MIL-PRF-39019/1 through 6 for the application government designations. The AIRPAX cage code number is 81541.

SINGLE POLE CIRCUIT PROTECTORS

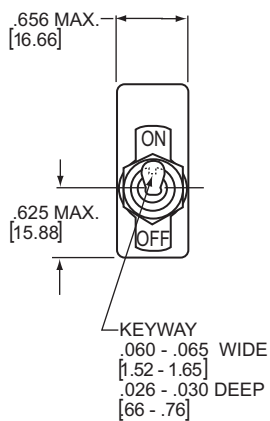
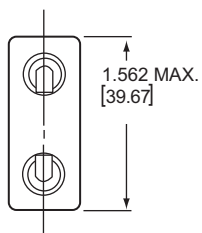
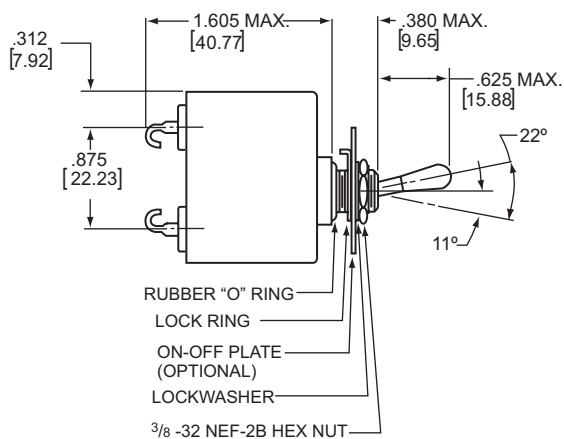

Mounting Detail

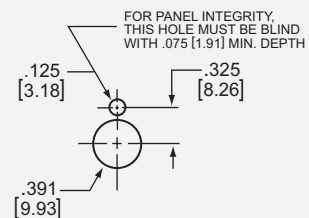

Panel Mounting Detail: Tolerance for Mtg. $\pm .005$ [.13]
 Maximum Panel Thickness: .156 [3.96]

MULTI-POLE CIRCUIT PROTECTORS

AP Multi-Pole Combinations

Circuit demands and design ingenuity suggest a limitless number of special combinations, ranging from a two pole unit with one series breaker and a simple ON-OFF switch, to a more complex three pole unit having one series, one shunt and one relay configuration with auxiliary indicator circuit contacts. Please contact Airpax for specific part number.

Two Pole, AP12

Two of the basic units are combined in a sealed case to provide protection for dual circuit. A single toggle handle actuates both internal trip mechanisms. Conversely, an overload in either circuit trips both simultaneously.

The AP12 consists of two independent series trip protectors, each available with its own rating and delay characteristics.

This two pole unit can therefore have an unlimited number of combinations, which makes ordering by a code system impractical. Thus, if the poles differ, a descriptive drawing is recommended.

One frequent use of two pole protectors is to interrupt either or both sides of a power line. Likewise, three pole protectors often use three identical coils. However, any two or three pole protectors may have any coil of any delay in any desired combination. (Unless otherwise specified, we assume the two or three poles to be all alike.)

Two Pole, AP12, Toggle

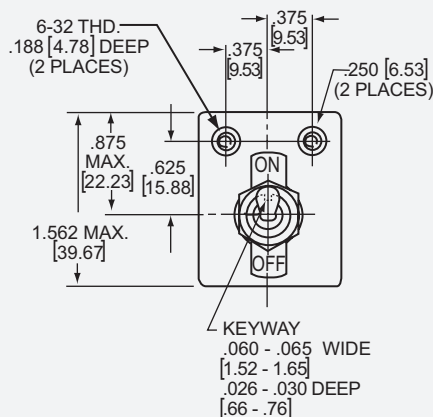
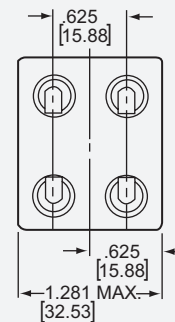
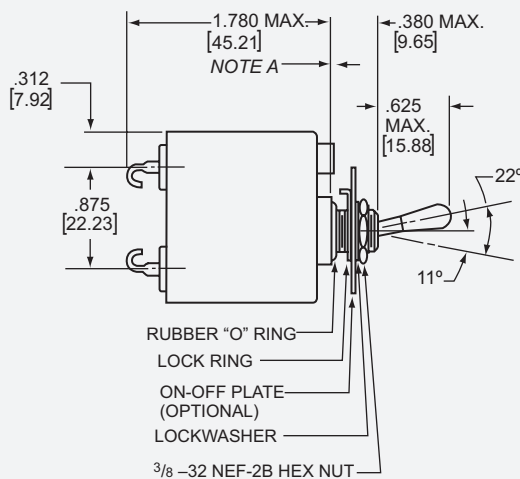

Mounting Detail

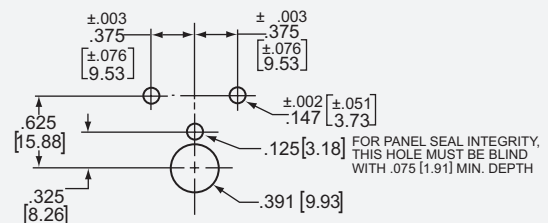

Panel Mounting Detail: Tolerance for Mtg. $\pm .005$ [.13]
Panel Thickness: .125-.156 [3.18-3.96]

Note: Tolerance $\pm .031$ [.79] Angles: $\pm 5^\circ$ unless noted. Dimensions in brackets [] are millimeters.
A: Threaded inserts exceed seated height of bushing by .005-.015 [.13-.38]

All multi-pole units have provisions for a rugged three point panel mount. Use of 6-32 panel seal screws together with the bushing mount is recommended to maintain specification shock and vibration levels.

Three Pole, AP112

Three circuits may be simultaneously protected. One actuating toggle handle closes all circuits and all poles trip in the presence of an overload on any circuit. Some typical combinations could be: 3 series poles; 2 series and one shunt; 2 series and one relay; or 3 series with a set of auxiliary contacts. Like the two pole protectors, each pole may have different ratings and delays.

Three Pole, AP112, Toggle

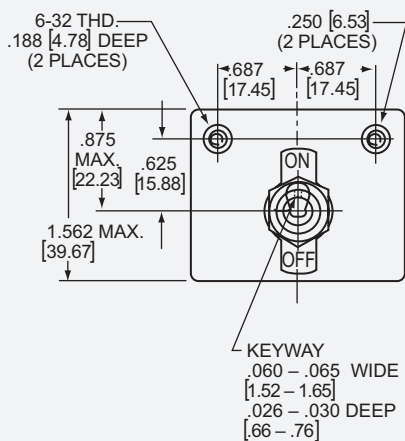
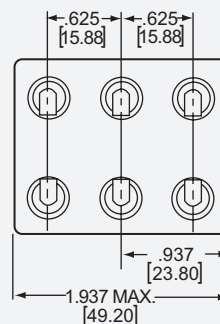
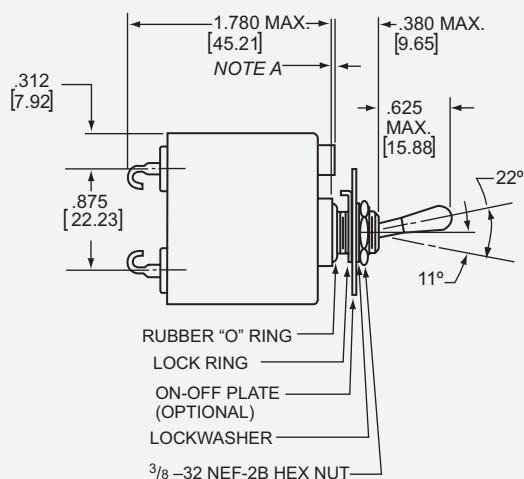

Mounting Detail

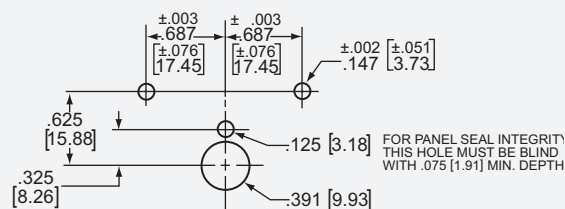

Panel Mounting Detail: Tolerance for Mtg. ±.005 [0.13]
 Panel Thickness: .125-.156 [3.18-3.96]

CONFIGURATIONS

Series Trip

The most popular configuration for magnetic protectors is the series trip where the sensing coil and contacts are in series with the load being protected. The handle position conveniently indicates circuit status. In addition to providing conventional overcurrent protection, it's simultaneously used as a power disconnect.

Shunt Trip

The shunt trip is designed for controlling two separate loads with one assembly. The control is established by providing overload protection for the critical load. When the current through this load becomes excessive and reaches the trip point the protector will open and remove power from both loads simultaneously. The total current rating of both loads must not exceed the maximum contact rating.

Relay Trip

This permits the overload sensing coil to be placed in a circuit which is electrically isolated from the trip contacts. The coil may be actuated by sensors monitoring pressure, flow, temperature, speed, etc. Other typical applications include crowbar, interlock and emergency/rapid shutdown circuitry. Trip may be accomplished by voltage or current, which must be removed immediately upon tripping.

Remote Indication, AP1-1R

AP series trip circuit protectors are available with electrically isolated contacts which are rated at 1/2 ampere, 120 volts AC or 50 volts DC. These contacts provide SPDT switching action which can be used to indicate "power-on" and "power-off" conditions or to actuate lights, alarms or timing devices.

Voltage Trip

Sometimes called "dump circuits" or "panic trip circuits," these units make it possible to open main power contacts with lower power inputs from one or more sources. This configuration is becoming increasingly more important for sensitive circuitry and denser packaging in automation systems. Available in series, shunt or relay configurations.

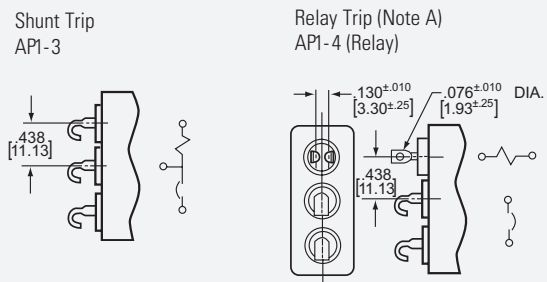
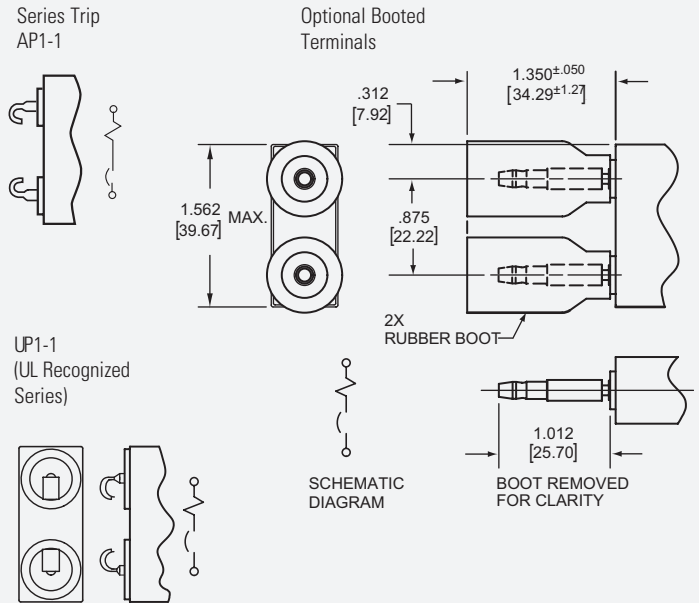

Series with Auxiliary Switch
AP1-1R (Note A)

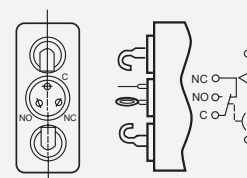

Switch with Auxiliary Switch
AP1-1RC (Note A)

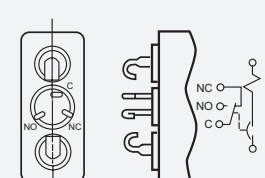

AP7-1 (Screw Terminal with Terminal Block)

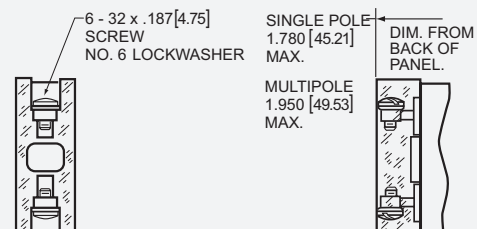

Note: Tolerance $\pm .031$ [7.9] Angles: $\pm 5^\circ$ unless noted.
Dimensions in brackets [] are millimeters.
A. Main protector contacts open.

OPERATIONAL CHARACTERISTICS

Inrush Pulse Tolerance

The following table provides a comparison of inrush pulse tolerance with and without the inertial delay feature for each of the 50/60Hz delays. Pulse tolerance is defined as a single pulse of half sine wave peak current amplitude of 8 milli-seconds duration that will not trip the circuit protector.

| DELAY VS PEAK AMPLITUDE | |
|-------------------------|--------------------------------|
| Delay | Peak Amplitude |
| 61, 62, 71, 72, A, B | 4 Times Rated Current (60Hz) |
| 61F, 62F, 71F, 72F | 6.5 Times Rated Current (60Hz) |
| 64, 65 | 10 Times Rated Current (60Hz) |
| 64F, 65F | 13 Times Rated Current (60Hz) |
| 41, 42, AF, BF | 14 Times Rated Current (400Hz) |
| 41F, 42F | 20 Times Rated Current (400Hz) |
| 51, 52 | 6 Times Rated Current (60Hz) |
| 51F, 52F, AF, BF | 8 Times Rated Current (60Hz) |

SERIES RESISTANCE NOMINAL VALUES @ +25°C

| Current Ratings DC, 50/60Hz, 400 Hz (Amps) | DC Series Resistance All Delays except 40, 50, 60 (ohms) | DC Series Resistance Delays 40, 50, 60 (ohms) |
|--|--|---|
| 0.050 | 470 | 105 |
| 0.100 | 145 | 27.0 |
| 0.250 | 18.0 | 3.80 |
| 0.500 | 4.30 | 1.00 |
| 0.750 | 1.60 | 0.400 |
| 1.00 | 1.15 | 0.230 |
| 2.00 | 0.298 | 0.060 |
| 3.00 | 0.130 | 0.033 |
| 5.00 | 0.052 | 0.012 |
| 7.50 | 0.025 | 0.007 |
| 10.0 | 0.016 | 0.006 |
| 15.0 | 0.006 | 0.005 |
| 20.0 | 0.005 | 0.004 |

Tolerance at ±25% values based on V-A method after 1 hour stabilization at 100% rated current. Consult factory for other limits.

PERCENTAGE OF RATED CURRENT VS TRIP TIME IN SECONDS AT +25°C (VERTICAL MOUNT)

| Delay | 100% | 125% (Note A) | 200% | 400% | 800% |
|-------------|---------|---------------|--------------|--------------|--------------|
| 40* | No Trip | .035 Max | .025 Max | .015 Max | .015 Max |
| 41 | No Trip | .200 to 7 | .055 to .950 | .010 to .240 | .005 to .080 |
| 42 | No Trip | 3 to 60 | .500 to 9 | .010 to 1.75 | .005 to .100 |
| 49* | No Trip | .100 Max | .050 Max | .020 Max | .015 Max |
| 50* | No Trip | .035 Max | .025 Max | .015 Max | .015 Max |
| 51 | No Trip | .400 to 4 | .060 to .600 | .010 to .200 | .005 to .035 |
| 52 | No Trip | 4 to 40 | .600 to 6 | .010 to 1.50 | .005 to .050 |
| 59* | No Trip | .100 Max | .050 Max | .020 Max | .015 Max |
| 60* | No Trip | .035 Max | .025 Max | .015 Max | .015 Max |
| 61 | No Trip | .500 to 5 | .070 to .700 | .020 to .200 | .008 to .080 |
| 62 | No Trip | 4 to 40 | .800 to 8 | .010 to .300 | .005 to .080 |
| 64 | No Trip | .900 to 10 | .200 to 1.70 | .040 to .500 | .012 to .100 |
| 65 | No Trip | 9 to 60 | 1.15 to 7 | .110 to 1 | .010 to .190 |
| 69* | No Trip | .100 Max | .050 Max | .020 Max | .015 Max |
| 71 (Note B) | No Trip | .200 to 7 | .055 to .950 | .010 to .240 | .005 to .080 |
| 72 (Note B) | No Trip | 3 to 60 | .500 to 9 | .010 to 1.75 | .005 to .100 |
| 79 (Note B) | No Trip | .100 Max | .050 Max | .020 Max | .015 Max |

*Notes: Instantaneous delays (40, 49, 59, 60, 69, 79) are not compatible with inrush enhancement options and are not recommended for general use.

A. 150% for delays 40, 50 & 60. 135% minimum trip for delays 41, 42, 49, 71, 72 & 79.

B. Military time delays. 71=A, 72=B, 79=C

TYPICAL DELAY CURVES

The delay curves below illustrate our standard instant, short and long delays. Please consult factory for specific delay curves or refer to table on page 87.

Delay curves 64 and 65 illustrate the improved inrush tolerance provided compared to standard delays. Not available in MIL configurations.

All trip times and trip currents are specified with the breaker mounted in the normal vertical position at ambient temperature of 25°C. For time delay test and measurement purposes, the breakers should not carry current prior to application of overload.

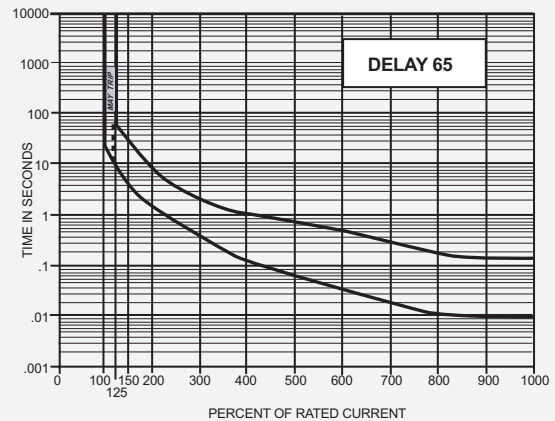
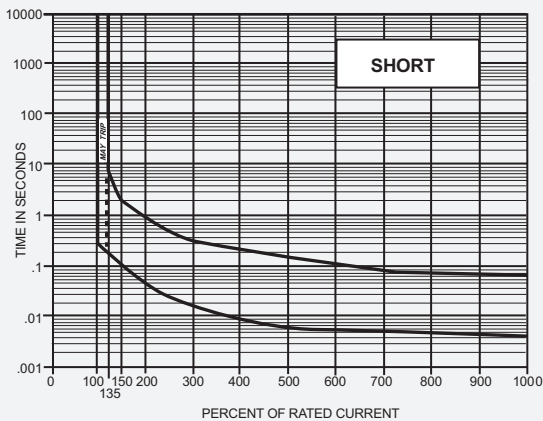
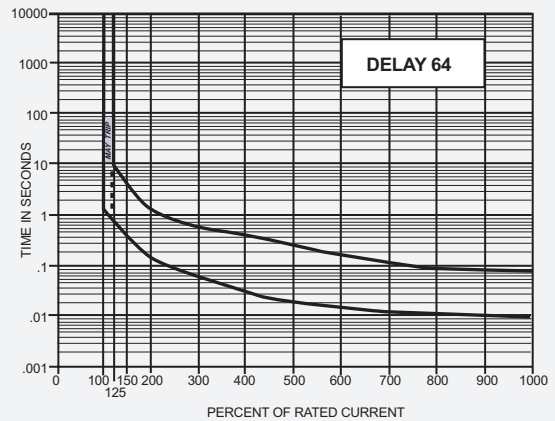
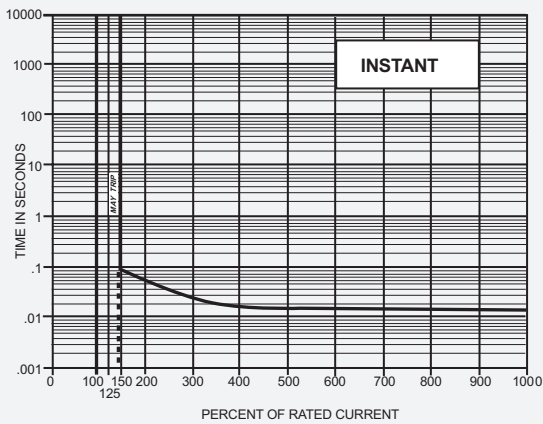
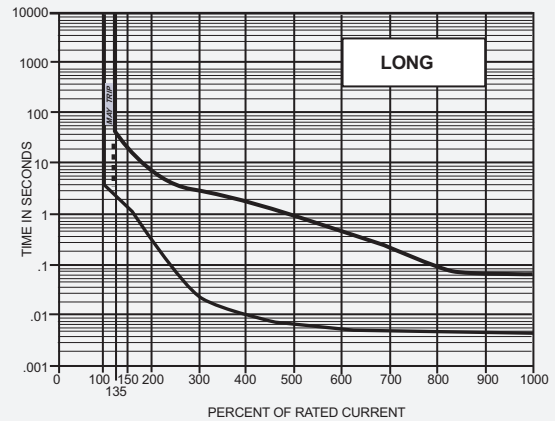

Trip Free

AP circuit protectors will trip open on overload, even when forcibly held ON. This prevents the operator from damaging the circuit by holding the handle in the ON position.

Trip Indication

The operating handle of the breaker moves forcibly and positively to the OFF position on overload. It is not necessary to manually “reset” to full “OFF” in order to turn it on again.

Ambient Operation

The protector will operate at any ambient between -40° C and $+100^{\circ}$ C, when tested in accordance with the requirements of MIL-PRF-39019.

Insulation Resistance

Exceeds 100 megohms at a potential of 100Vdc.

Dielectric Strength

The protector will withstand 1250 volts RMS, 60Hz from terminals to case and between the terminals when open.

Endurance

With the circuit protector operated as an ON-OFF switch, operating life exceeds 10,000 operations at a rate of 6 per minute when tested as follows: 6000 OPS @ rated current plus 4000 OPS @ no load.

Ratings

AP protectors are available in current ratings from 50 milliamperes to 20 amperes, 50 volts DC or 240 volts AC, maximum, 60 Hz or 400 Hz. UP protectors are UL 1077 and CSA approved as per the following table. Please consult factory for ratings other than those noted.

Lever Strength

The operating lever or its seal will not be damaged by a 10 lb. force applied in any direction.

Shock

All protectors withstand 100G without tripping, even while carrying full rated current with shock applied in any plane of 6 ms duration. Test is made according to Method 213, Test Condition I or MIL-Std-202 as outlined in Paragraph 4.6.14 of MIL-PRF-39019. Delay 40, 50 and 60 breakers are tested at 80% of rated current.

Vibration

All protectors withstand vibration from 10 to 55 cycles at .06 double amplitude and 55 to 2000 cycles at 10G, applied in any plane, without damage and without tripping even while operating at full rated current. Test is made in accordance with Method 204A, Test Condition C, of MIL-Std-202 as outlined in Paragraph 4.6.12 of MIL-PRF-39019. Delay 40, 50 and 60 protectors are tested at 80% of rated current.

Short Circuit Capacity

When tested in accordance with the procedures of UL1077, AP supplementary protectors have a short circuit capacity of 1000 amperes at 32Vdc, 120Vac, 240Vac, 60 or 400Hz. Parts are recognized to UL1077 for type UP1 only. The rated Rupture Capacity per MIL-PRF-39019 is 500 amperes, 50 volts DC, 500 amperes, 120 volts AC and 300 amperes, 240 volts AC, 60 or 400Hz.

Case Seal

The breaker is fully sealed and will not show evidence of leakage under total immersion. Meets requirements of MIL-PRF-39019.

Panel Seal

The “O” ring provides, with the other illustrated hardware, a seal against a pressure differential of 15 psi applied for an hour.

| RATINGS | | | | | | | |
|---------|---------------|------------------|----|----|---------------------------------|-----|-------|
| Series | Voltage | Current | TC | OL | Short Circuit Rating (SC, amps) | CSA | Phase |
| UP | 50 VDC | 0.05 to 20 amps | 1 | 1 | U1, 1000 | YES | — |
| UP | 240 VAC | 0.05 to 7.5 amps | 1 | 0 | C1, 1000 4X fuse max | YES | 1 |
| UP | 120 VAC | 0.05 to 15 amps | 1 | 1 | C1, 1000 4X fuse max | YES | 1 |
| UP | 240 VAC (400) | 0.05 to 7.5 amps | 1 | 0 | C1, 1000 4X fuse max | YES | 1 |
| UP | 120 VAC (400) | 0.05 to 15 amps | 1 | 0 | C1, 1000 4X fuse max | YES | 1 |

| RECOMMENDED TORQUE SPECIFICATIONS | |
|-----------------------------------|-----------------|
| Component | Torque (in-lbs) |
| 6-32 Mounting Inserts | 6 to 8 |
| 6-32 Screw Terminals | 6 to 8 |
| 3/8-32 Mounting Bushing Nut | 20 to 25 |

| AUXILIARY SWITCH RATING | | | |
|-------------------------|---|---------|--------|
| 3.0 amps | @ | 120 VAC | 50 VDC |

| APPROXIMATE WEIGHT PER POLE | |
|-----------------------------|----------|
| 1.8 Ounces | 49 Grams |

HOW TO ORDER

The ordering code for AP magnetic circuit protectors may be determined by following the steps in the decision tables shown here.

For example, the following is the code for a two pole AP, hook terminal, series unit, designed for operation in a DC circuit. It has a short time delay and a rating of 20 amperes. The coding given permits a descriptive part number, with limitations. In the illustrated double pole example (AP12-1-51-203), it is automatically assumed that both poles are identical. One great virtue of magnetic circuit protectors is their adaptability to complex circuits, thus variations from pole to pole become the rule rather than the exception. Descriptive drawings are recommended. In this event, factory assigned part numbers are utilized.

To determine the ordering number for your particular AP unit, simply follow the steps shown. You may use this number to place a order or as a reference for further questions you may have.

Notes:

A The UP has a wide glass terminal to meet UL and CSA creepage specifications. Except as completely non-standard there is no space for more than two terminals and the UP is therefore limited to only the single pole series circuit configuration (Third Decision Table – 1). Delays available in the UP are: 40, 50 and 60; 41, 51 and 61; 42, 52 and 62; 64, 65, 69, 71, 72 and 79.

B Users should refer to the applicable drawings of MIL-PRF-39019. Configurations vary dependent upon the revision of MIL-PRF-39019. The 6-32 threaded mounted bushings, useful for added strength, are approved under this specification.

To assure that proper parts are received, consult the factory for application assistance if there is any doubt about which version is correct for the application concerned.

C Screw terminals are available and are equipped with standard terminal block. Space permits their use only in the series configuration (Third Decision Table). Standard terminals are heavy copper hooks.

D Screw terminals with SPDT auxiliary switch, available only with the series circuit, may have "R" soldering terminals, flattened and pierced, or "RC" soldering terminals which are cane hooks. Screw terminals (-7, -17, -117) are available with SPDT auxiliary switch "R" type only.

E The nominal current values for 100% of rated current (see delay curves) are those listed. Other values can be readily supplied, in general, without delayed delivery. For values above or below the listed range, please consult an Airpax sales office or sales representative.

F Consult factory for assigned part numbers.

Example:

AP12 -1 -51-203-FM

1 2 3 4 5 6

| 1 First Decision | |
|-----------------------------|---|
| Type | |
| AP | Fully sealed magnetic circuit protector |
| UP (Note A) | Underwriters' Laboratories recognized circuit supplementary protector |
| AP - MIL (Note B) | /1 through /6 QPL per MIL-PRF-39019 |

| 6 Optional | |
|---|--|
| FM Approved (Factory Mutual Research) | |
| Add -FM to part number to indicate FM approval. FM approval is available for Single Pole, Series Trip, UP type units only. TA = -40°C to +65°C | |
| Units < 10A are rated CL 1, DIV 2, Group ABCD, T6 | |
| Units > 10A are rated CL 1, DIV 2, Group ABCD, T4A | |

| 2 Second Decision (Note C) | | |
|----------------------------|-----------------|---|
| Poles | | |
| Hook Terminals | Screw Terminals | |
| 1 | 7 | Single pole unit, mounted with 3/8 threaded bushing |
| 12 | 17 | Two pole unit, bushing plus (2) 6-32 threaded inserts |
| 112 | 117 | Three pole unit, bushing plus (2) 6-32 threaded units |

| 4 Fourth Decision | |
|-------------------|---|
| Hz and Delay | |
| -40 | 400Hz 150% instant trip* |
| -41 | 400Hz short time delay |
| -42 | 400Hz long time delay |
| -49 | 400Hz 135% instant trip* |
| -50 | DC 150% instant trip* |
| -51 | DC short time delay |
| -52 | DC long time delay |
| -59 | DC 125% instant trip* |
| -60 | 50/60Hz 150% instant trip* |
| -61 | 50/60Hz short time delay |
| -62 | 50/60Hz long time delay |
| -64 | 50/60Hz high pulse, short time delay (50/60Hz only) |
| -65 | 50/60Hz high pulse, long time delay (50/60Hz only) |
| -69 | 50/60Hz 125% instant trip* |
| -71 | DC, 50/60Hz, 400Hz short time delay 135% trip |
| -72 | DC, 50/60Hz, 400Hz long time delay 135% trip |
| -79 | DC, 50/60Hz, 400Hz instant time delay 135% trip* |

| 5 Fifth Decision (Note E) | |
|---------------------------|---------|
| Nominal Amperage Rating | |
| Code | Amperes |
| -051 | .050 |
| -101 | .100 |
| -201 | .200 |
| -251 | .250 |
| -401 | .400 |
| -501 | .500 |
| -601 | .600 |
| -751 | .750 |
| -102 | 1.000 |
| -1251 | 1.250 |
| -1751 | 1.750 |
| -202 | 2.000 |
| -252 | 2.500 |
| -302 | 3.000 |
| -502 | 5.000 |
| -702 | 7.000 |
| -752 | 7.500 |
| -802 | 8.000 |
| -103 | 10.000 |
| -123 | 12.000 |
| -153 | 15.000 |
| -173 | 17.000 |
| -203 | 20.000 |

| 3 Third Decision | |
|-------------------------|---|
| Internal Configuration | |
| -0 | Switch Only (Omit 4th and 5th Decisions) |
| -1 | Series |
| -1R (Note D) | Series with Auxiliary Switch with pierced pin terminals |
| -1RC (Note D) | Series with Auxiliary Switch with cane hook terminals |
| -3 | Shunt |
| -4 | Relay (5 amps max coil rating) |

Multi-pole units with mixed construction, poles numbered left to right when viewed from terminal end (Note F).

For addition of inertial delay, add an "F" to any delay number. Except 40, 50 & 60.

*Instantaneous delays are not compatible with inrush enhancement options and are not recommended for general use.

See page 61 for maximum voltage ratings.

Note: Standard current ratings listed. For other ratings, please consult the factory.

AIRPAX®

IPA/CPA Series Magnetic Circuit Protectors



- Introduction* • 83
- Poles* • 84
- PC Board Mount* • 87
- Configurations* • 89
- Operating Characteristics* • 90
- Delay Curves* • 91
- Specifications* • 93
- Decision Tables* • 95



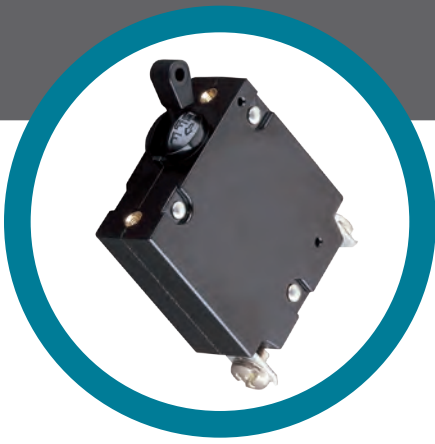

AIRPAX® | IPA/CPA Series

Hydraulic Magnetic Circuit Protectors

INTRODUCTION

The Airpax™ IPA/CPA hydraulic-magnetic circuit protectors provide low-cost power switching, reliable circuit protection and accurate circuit control for equipment in the international marketplace.

IPA models meet IEC spacing requirements that are mandatory for equipment which must comply with IEC specifications 601 and 950 and VDE specifications 0804 and 0805. In addition, they are UL Recognized as supplementary protectors per UL STD. 1077, CSA Certified as supplementary protectors per CSA C 22.2-No. 235, TUV Approved to VDE 0642 (EN60934), CCC Approved (pending) and CE Compliant.

Designed using the latest in sensitive hydraulic magnetic technology, the IPA line adapts itself to many applications and environments. They're ideal for data processing and business

machines, medical instrumentation, broadcast equipment, vending and amusement machines, military applications and wherever precision operation is required. Temperature differences which affect fuses and other thermal devices are not a concern.

One important feature of this protector line is a "trip free" action, which means the circuit will trip in the presence of an overload even though the handle is held in the ON position. The delay mechanism senses the fault and the contacts open.

The IPA is available in configurations including series and series with auxiliary switch, with a choice of delays and ratings in either DC, 50/60Hz or 400Hz versions. Single or multi-pole versions are available, with a variety of pole arrangements to meet your specifications.

SINGLE POLE (ONE HANDLE)

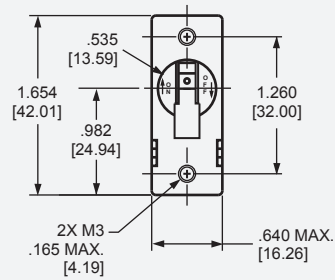
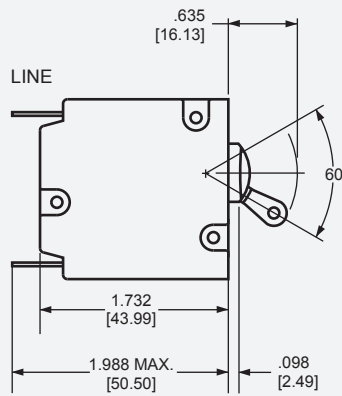

Mounting Detail

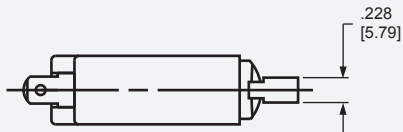
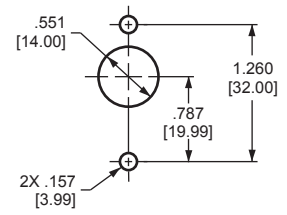

Notes:

1. Tolerance $\pm .015$ [.38] unless noted. Dimensions in brackets [] are millimeters.
2. Main circuit breaker terminals are stationary male push-on type: .248 [6.30] wide x .031 [.787] thick x .474 [12.00] long, or screw type: M4 x .354 [8.99] wide x .031 [.787] thick x .474 [12.00] long.

MULTI-POLE CIRCUIT PROTECTORS

Two Pole Protectors

An assembly consisting of two single pole units, having their trip mechanisms internally coupled and with a single toggle handle, forms the IPA-11 with quick-connect D.I.N.-style terminals. Individual poles may differ in ratings, delays and internal connections. An auxiliary switch may be included in either or both poles, allowing you to mix SELV and hazardous voltages. Rugged screw-type terminals can be provided, in which case the designation would be IPA-66. The IPAH offers a toggle handle for each pole.

Three Pole Protectors

The three pole construction consists of three single pole units assembled with an internal mechanical interlock which actuates

all units simultaneously. A single toggle handle operates all three poles for quick and convenient control, or if preferred, a handle per pole is available. The individual poles need not have identical characteristics and any series trip pole may have an auxiliary switch. If screw-type terminals are required, the breaker designation will be IPA-666 for a three pole version.

Breaker poles are numbered consecutively when viewed from the terminal side, with the ON position up, starting with Pole #1 on the left side and proceeding to the right.

Handles

The IPAH two and three pole models are available with a handle per pole.

Two Pole Protectors
(one handle)

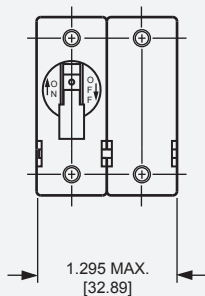

(Optional: Handle may be located in Pole 1 instead of Pole 2)

Three Pole Protectors
(one handle)

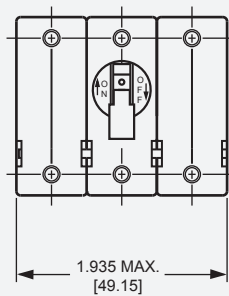

Mounting Details

Two Pole

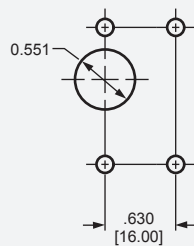

Three Pole

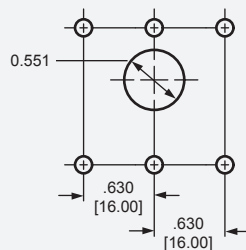

Note: Tolerance $\pm .015$ [.38] unless noted. Dimensions in Brackets [] are millimeters.



Two Pole Protectors
(one handle)

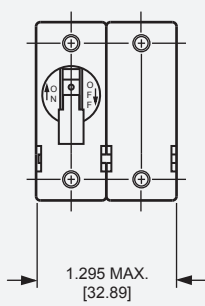

Three Pole Protectors
(one handle)

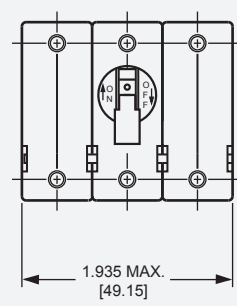

(Optional: Handle may be located in Pole 1 instead of Pole 2)

Mounting Details

Two Pole

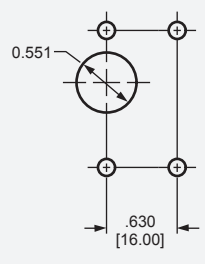

Three Pole

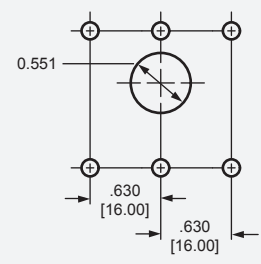

Note: Tolerance $\pm .015$ [.38] unless noted. Dimensions in Brackets [] are millimeters.

PC (PRINTED CIRCUIT) BOARD MOUNTED CIRCUIT PROTECTORS

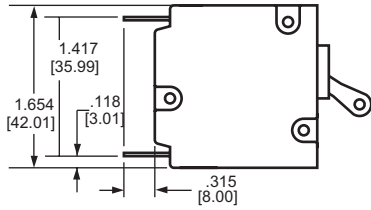

Printed Circuit Board Mounting Terminal Type "S"

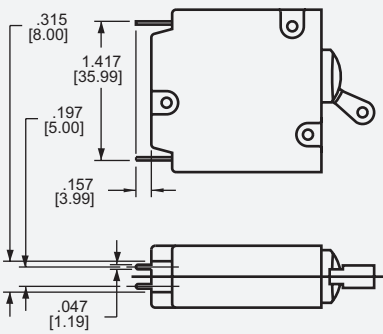

Mounting Detail

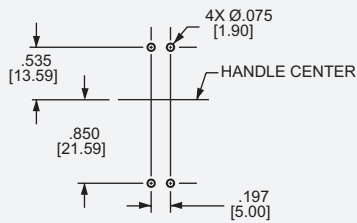

(Auxiliary switch is not recommended with this type mounting.)

Note: Tolerance $\pm .015$ [3.8] unless noted.
Dimensions in brackets [] are millimeters.

Printed Circuit Board Mounting Terminal Type "R"

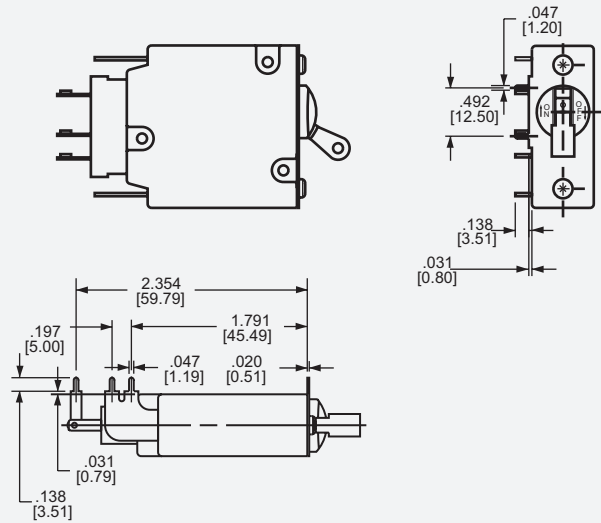

Mounting Detail

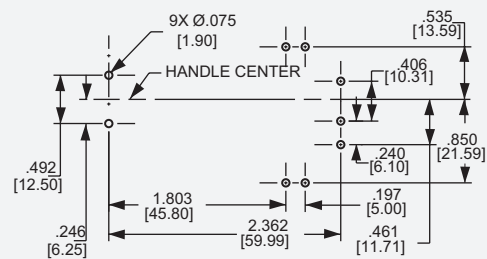

Printed Circuit Board Mounting Terminal Type "L"

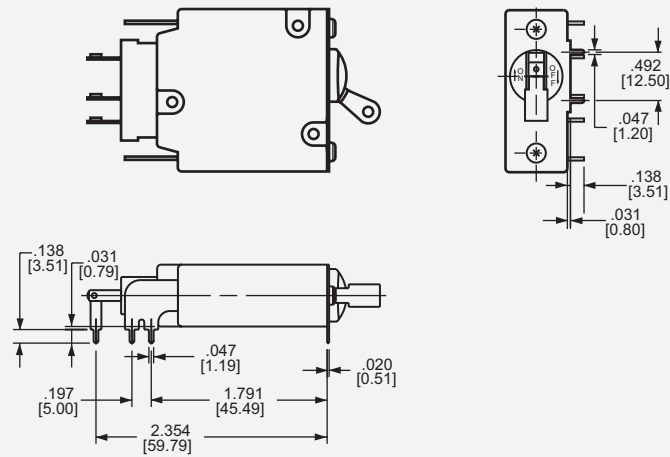

Mounting Detail

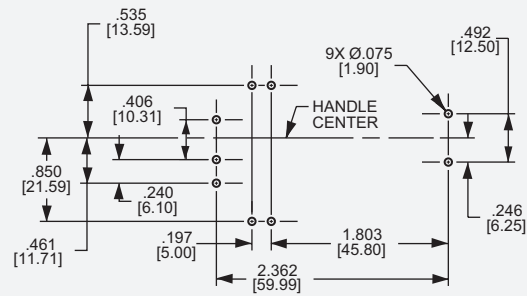

Note: Tolerance $\pm .015$ [.38] unless noted.
Dimensions in brackets [] are millimeters.

CONFIGURATIONS

Series Trip

The most popular configuration for magnetic protectors is the series trip where the sensing coil and contacts are in series with the load being protected. In addition to providing conventional overcurrent protection, the handle position conveniently indicates circuit status.

Auxiliary Switch (Applies to Series Trip Only)

This is furnished as an integral part of a series pole in single or multi-pole assemblies. Isolated electrically from the protector's circuit, the switch works in unison with the power contacts and provides indication at a remote location of the protector's on-off status.

Auxiliary switch contacts actuate simultaneously with the main breaker contacts, and will open regardless of whether the breaker contacts are opened manually or electrically. For auxiliary switch ratings below 6Vac or 5Vdc, an auxiliary switch with gold contacts, designated as REG, is available. Gold contacts are not recommended for load current above 100 milliamps. An optional auxiliary switch, RS, configuration allows an alarm or signal to be forwarded only upon electrical overload, allowing for easier detection of fault circuit.

| TYPICAL RESISTANCE / IMPEDANCE | | | |
|--------------------------------|--|--------------------|------------------|
| Current Ratings (Amps) | Series Type (Except delays 40, 50, 60) | | |
| | DC (ohms) | AC, 50/60Hz (ohms) | AC, 400Hz (ohms) |
| 0.050 | 427 | 478 | — |
| 0.100 | 100 | 103 | 204 |
| 0.250 | 19 | 20 | 34 |
| 0.500 | 4.6 | 6.3 | 8.2 |
| 0.750 | 2.04 | 2.06 | 3.52 |
| 1.00 | 0.91 | 0.92 | 1.86 |
| 2.50 | 0.17 | 0.19 | 0.28 |
| 5.00 | 0.045 | 0.046 | 0.073 |
| 7.50 | 0.018 | 0.019 | 0.037 |
| 10.0 | 0.013 | 0.014 | 0.020 |
| 15.0 | 0.0072 | 0.0073 | 0.0109 |
| 20.0 | 0.005 | 0.0051 | — |
| 25.0 | 0.003 | 0.0035 | — |

*DCR and Impedance values are based on measurements by the voltmeter ammeter method. Rated current is applied for one hour and at a voltage not less than 20 volts. Ambient temperature: 25 C; Tolerance: Below 10 amps ± 25%; Above 10 amps ± 50%; *Consult factory for special values and for coil impedance of delays not shown.*

Series Trip

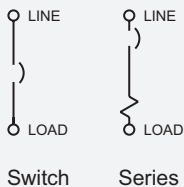
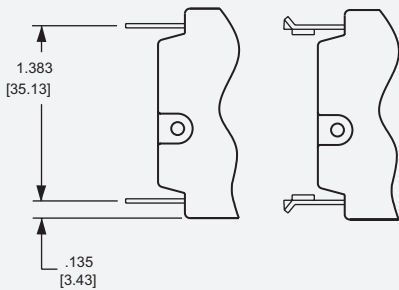

Notes:

1. Main circuit protector terminals are stationary male push-on type: .248 [6.30] wide x .031 [.787] thick x .474 [12.00] long, or screw type: M4 x .354 [8.99] wide x .031 [.787] thick x .474 [12.00] long.
2. Auxiliary switch terminals are: .110 [2.79] wide x .020 [0.51] thick x .343 [8.71] long.
3. Tolerance ± .015 [.38] unless noted. Dimensions in brackets [] are millimeters.

Series with Auxiliary Switch

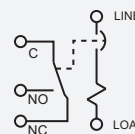
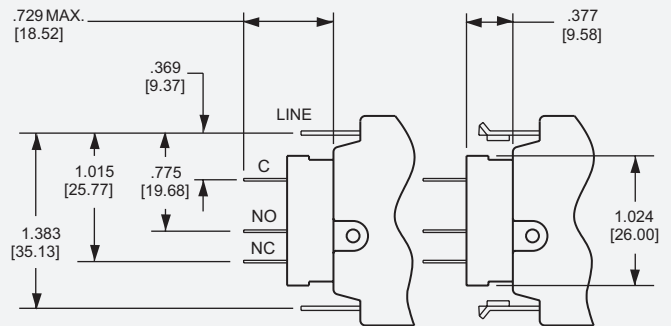

C-NC = Breaker in "OFF" position.

Series with Auxiliary Switch

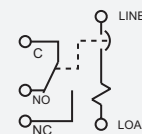

Breaker in "ON" or manually turned "OFF" position.

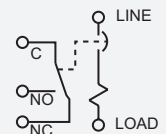

Breaker in electrically tripped "OFF" position.

Auxiliary Alarm Switch (IRS4, IRSG4)

AGENCY APPROVALS

| IPA Series | | | | Rated Current (Amps) | | Interrupting Capacity (Amps) | |
|--------------------|----------------|-------|---------------|----------------------|-----------|------------------------------|---------------|
| Max Voltage Rating | Frequency (Hz) | Phase | Minimum Poles | UL/CSA | TÜV | UL1077 & CSA | TÜV |
| 65 | DC | — | 1 | .05 to 30 | .05 to 25 | 3000 | 1000 (Note 1) |
| 80 | DC | — | 1 | .05 to 20 | — | 300 | — |
| 240 | 50/60 | 1 & 3 | 1 | 25.1 to 30 | — | 1000 (Note 1) | — |
| 250 | 50/60 | 1 & 3 | 1 | .05 to 25 | .05 to 25 | 1000 (Note 2) | 1000 (Note 1) |
| 250 | 50/60 | 1 | 2 | .05 to 30 | .05 to 30 | 1500 | 1500 (Note 1) |
| 250 | 400 | 1 & 3 | 1 | .10 to 15 | .05 to 15 | 1000 | 1000 (Note 1) |
| CPA Series | | | | Rated Current (Amps) | | Interrupting Capacity (Amps) | |
| Max Voltage Rating | Frequency (Hz) | Phase | Minimum Poles | UL/CSA | TÜV | UL1077 & CSA | TÜV |
| 65 | DC | — | 1 | 1 to 30 | — | 1000 | — |

Notes: (1) with 4 times rated series backup fuse.
(2) with 80A max. series fuse.

PERCENTAGE OF RATED CURRENT VS TRIP TIME IN SECONDS AT +25°C (VERTICAL MOUNT)

| Frequency | Delay | 100% | 125% | 150% | 200% | 400% | 600% | 800% | 1000% |
|-----------|-------|---------|------------|-----------|------------|------------|-------------|-------------|--------------|
| 400 Hz | 40 | No Trip | May Trip | May Trip | .090 Max | .060 Max | .050 Max | .040 Max | .035 Max |
| | 41 | No Trip | May Trip | .2 to 9 | .09 to 3 | .02 to .6 | .006 to .3 | .003 to .2 | .003 to .15 |
| | 42 | No Trip | May Trip | 3 to 80 | 1 to 25 | .06 to 4 | .01 to 1.5 | .004 to .6 | .003 to .3 |
| | 400 | No Trip | May Trip | 20 to 900 | 6 to 250 | .2 to 45 | .01 to 6 | .003 to .9 | .003 to .5 |
| DC | 51* | No Trip | .500 to 16 | .3 to 5 | .13 to 1.5 | .03 to .2 | .005 to .1 | .003 to .05 | .003 to .025 |
| | 52* | No Trip | 7 to 100 | 3 to 40 | .620 to 15 | .12 to 2.5 | .003 to .5 | .003 to .05 | .003 to .025 |
| | 59* | No Trip | .120 Max | .073 Max | .038 Max | .021 Max | .017 Max | .017 Max | .017 Max |
| | 500 | No Trip | 70 to 800 | 25 to 300 | 10 to 100 | 1.2 to 20 | .007 to 5 | .004 to .65 | .003 to .1 |
| 50/60 Hz | 61 | No Trip | .700 to 15 | .3 to 4 | .1 to 1.3 | .02 to .25 | .006 to .13 | .003 to .07 | .003 to .04 |
| | 62 | No Trip | 12 to 180 | 6 to 70 | 2 to 25 | .15 to 3.5 | .005 to .3 | .004 to .13 | .004 to .04 |
| | 69 | No Trip | .120 Max | .073 Max | .038 Max | .021 Max | .017 Max | .017 Max | .017 Max |
| | 600 | No Trip | 50 to 800 | 20 to 300 | 5.5 to 110 | .3 to 17 | .004 to .5 | .004 to .5 | .004 to .1 |

Notes: All trip times and trip currents are specified with the protector mounted in the normal vertical position at ambient temperature of 25 C.

Breakers do not carry current prior to application of overload.

*CPA type units are available only with 51, 52 and 59 delays.

DELAY CURVES - DC, 50/60HZ, 400HZ

A choice of delays is offered for DC, 50/60Hz and 400Hz applications.

Delays 40, 59 and 69 provide fast acting, instantaneous trip and are often used to protect sensitive electronic equipment (not recommended where a known inrush exists).

Delays 41, 51 and 61 have a short delay for general purpose applications.

Delays 42, 52 and 62 are long enough to start certain types of motors and most transformer and capacitor loads.

Delays 400, 500 and 600 are long delays for special motor applications.

DC Delay Curves (typ)

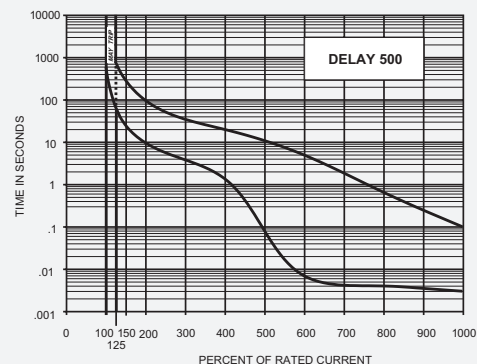
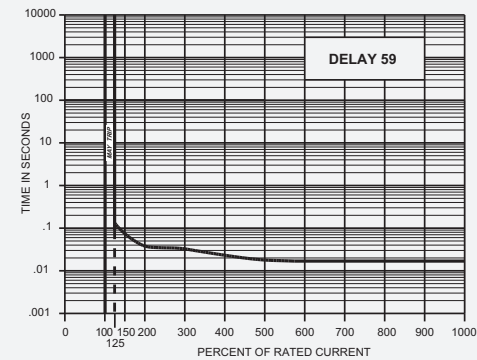
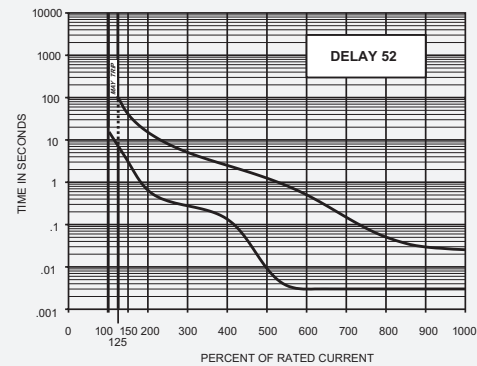
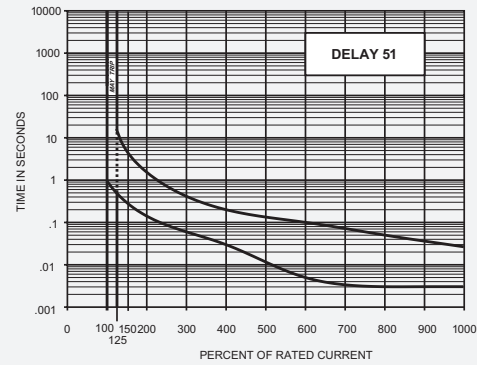

50/60Hz Delay Curves (typ)

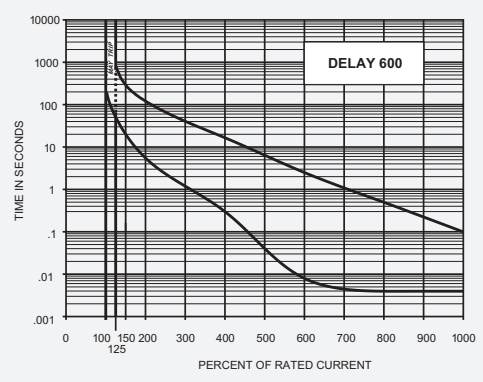
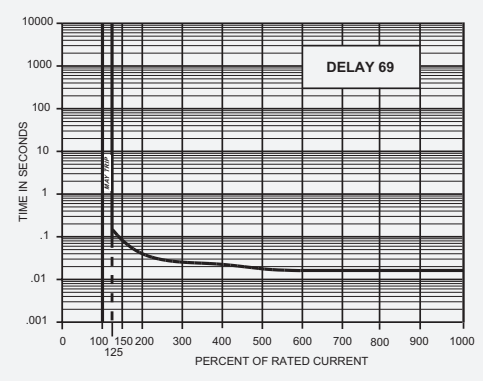
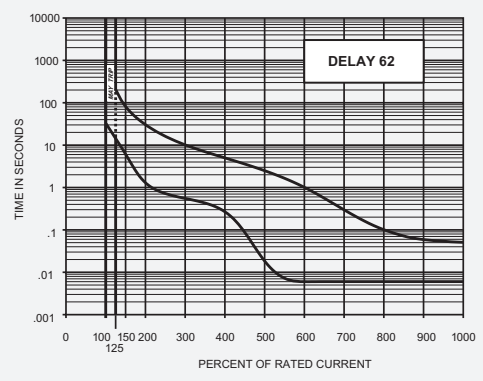
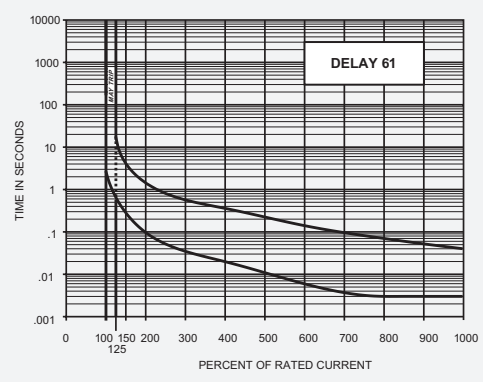

400Hz Delay Curves (typ)

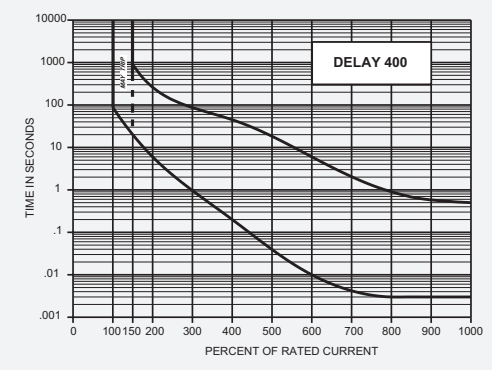
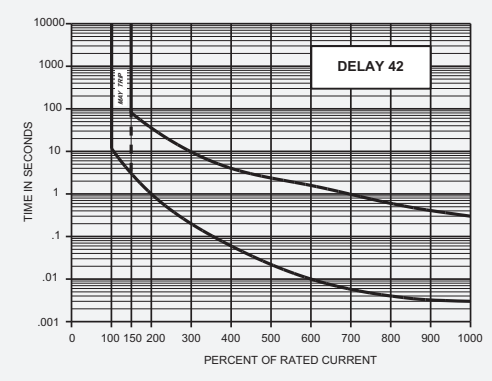
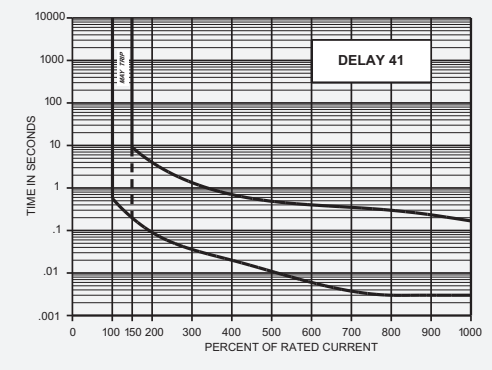
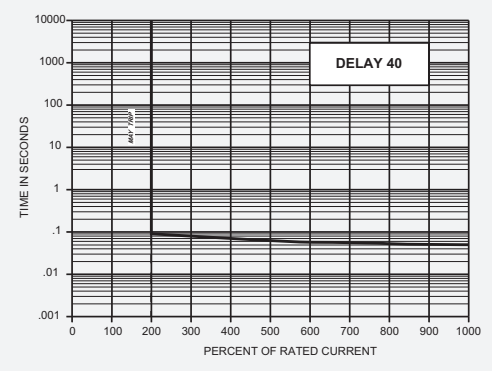

SPECIFICATIONS

Trip Free

Will trip open on overload, even when the handle is forcibly held on or restrained. This prevents operator from damaging the circuit by holding the handle in the ON position.

Trip Indication

The operating handle moves positively to the OFF position.

Ambient Operation

IPA protectors operate in temperatures between -40°C and $+85^{\circ}\text{C}$.

Insulation Resistance

Not less than 100 megohms at 500 volts DC.

Dielectric Strength

IPA protectors withstand 3000Vac, 60Hz for 60 seconds between all electrically isolated terminals except auxiliary switch terminals shall withstand 500Vac, 60Hz for REG and REC types.

Endurance

Operating as a switch, the operating life exceeds 10,000 operations, at rated current, at a rate of 6 per minute.

Electrical Characteristics

IPA protectors are rated .050 to 30 amperes 65Vdc; .050 to 30 amperes 240 Vac 50/60Hz; 0.050 to 15 amperes 250Vac, 400Hz.

Poles

One through three poles available.

Construction

Series and series with auxiliary switch available in various delays and combinations.

Auxiliary and Alarm Switch

When supplied shall be S.P.D.T. configuration with a maximum rating of 3.0 amperes, 250Vac resistive load. Gold contacts are rated at .100 amperes, 125Vac resistive load.

Moisture Resistance

Meet all the requirements of MIL-PRF-55629 when tested in accordance with Method 106 of MIL-STD-202.

Salt Spray (Corrosion)

Meet the requirements of MIL-PRF-55629 when tested in accordance with Method 101 of MIL-STD-202.

Shock

Circuit protectors shall not trip when tested per MIL-STD-202, Method 213, Test Condition B with 100% rated current applied to delayed units and 80% rated current to instantaneous units. Units with auxiliary switches will withstand 30G max.

Vibration

Circuit protectors shall not trip when vibrated per MIL-STD-202, Method 201, Test Condition A with 100% rated current applied to delayed units and 80% rated current to instantaneous units.

RECOMMENDED TORQUE SPECIFICATIONS

| Component | Torque (in-lbs) |
|-----------------------|------------------------|
| 6-32 Mounting Inserts | 6 to 8 |
| M3 Mounting Screws | 4 to 5 |
| M4 Terminal Screws | 10 to 12 |

Where applicable, mechanical support must be provide to the terminals when applying torque

APPROXIMATE WEIGHT PER POLE

| Ounces | Grams |
|---------------|--------------|
| 1.7 | 48 |

INRUSH PULSE TOLERANCE

| Delay | Pulse Tolerance |
|----------------|------------------------|
| 61, 62, 600 | 8 times rated current |
| 61F, 62F, 600F | 12 times rated current |

Comparison of inrush pulse tolerance is with and without the inertia delay feature for each of the 50/60 Hz delays. Pulse tolerance is defined as a single pulse of half sine wave peak current amplitude of 8 milliseconds duration that will not trip the circuit protector.

HOW TO ORDER

The ordering code for IPA/CPA protectors may be determined by following the steps in the decision tables shown here.

| 1 First Decision | |
|------------------|---|
| Type | |
| IPA | One toggle handle per unit UL Recognized |
| IPAP | One toggle handle per unit UL Recognized PC board mount |
| IPAH | One toggle handle per pole UL Recognized |
| IPAHP | One toggle handle per pole UL Recognized PC board mount |
| CPA | One toggle handle per unit UL Listed per UL489A |
| CPAH | One toggle handle per pole UL Listed per UL489A |

| 2 Second Decision | |
|-------------------|--|
| Poles | |
| -1 | Single pole w/ quick connect terminals or PC board if P is used. |
| -11 | Two pole w/ quick connect terminals or PC board if P is used. |
| -111 | Three pole w/ quick connect terminals or PC board if P is used. |
| -6 | Single pole w/ screw terminals |
| -66 | Two pole w/ screw terminals |
| -666 | Three pole w/ screw terminals |

Note:

A The coding given permits a self-assigning part number. Other configurations may require a factory assigned part number. Typical examples are units with mixed ratings, combinations of styles or construction. With these, it is suggested that order entry be by description and/or drawings and a part number will be assigned. Additionally, it is a standard policy to establish a factory assigned part number wherever a descriptive drawing exists to provide cross reference, traceability and manufacturing control.

Example:

IPAP -1 -1REC4 - 61- 10.0 - L - 01 - T

1 2 3 4 5 6 7 8

| 3 Third Decision | |
|------------------|---|
| Configurations | |
| -0 | Switch only |
| -1 | Series |
| -1REC4 | Series with silver contact Auxiliary switch |
| -1REG4 | Series with gold contact Auxiliary switch |
| -1RS4 | Series with silver contact Alarm switch |
| -1RSG4 | Series with gold contact Alarm switch |

Notes: 1. For switch type, eliminate 4th & 5th decision.
 2. Switch will be marked with Max. current & voltage.
 3. The alarm switch is located in the handle pole for single handle types and in pole 2 for units with a handle per pole. The auxiliary switch may be located in any pole. However the standard location is in pole 2.
 4. Switch type with alarm switch must be multi-pole connected to a pole equipped with either an overcurrent or overvoltage mechanism.
 (Consult factory for further information.)

| 4 Fourth Decision | |
|-------------------|----------------------|
| Frequency & Delay | |
| SW | Switch only |
| -40 | 400Hz instant trip |
| -41 | 400Hz short delay |
| -42 | 400Hz long delay |
| -400 | 400Hz motor start |
| -50 | DC instant trip* |
| -51 | DC short delay* |
| -52 | DC long delay* |
| -500 | DC motor start |
| -60 | 50/60Hz instant trip |
| -61 | 50/60Hz short delay |
| -62 | 50/60Hz long delay |
| -600 | 50/60Hz motor start |

Note: For addition of inertial delay, add an "F" to any delay numeral. (Example: 62F)
 *CPA types are only available with DC ratings.

| 5 Fifth Decision | |
|--|--|
| Rated Current | |
| Use three numbers to specify required value within ranges described below. | |
| Rating | |
| 0.50 to 30.0* | |

Notes: 1. On multi-pole units, the poles are numbered left to right when viewed from terminal end.
 2. *15 amps maximum at 400Hz

| 6 Sixth Decision (Optional) | |
|-----------------------------|--|
| Mounting & Terminal Type | |
| A- | Metric M3 mounting inserts and if screw terminals M4. |
| L- | PC board mounting plate & terminals, 90 facing left |
| R- | PC board mounting plate & terminals, 90 facing right |
| S- | PC board terminals, rear facing with front panel insert mount. |

Note: Right and Left determined with breaker viewed from the rear, in normal vertical mounted position. (see pages 70 & 71)

| 7 Seventh Decision | |
|--------------------|-------------------------|
| Handle Color | |
| 01 | Black with I/O markings |

| 8 Eighth Decision (Optional) | |
|------------------------------|------|
| Agency Approval | |
| T | TÜV* |
| C | CCC |

Notes: 1. *25 amperes max rated current for TÜV approval.
 2. CCC Approval is pending.

AIRPAX[®]

IAG/IUG/IEG/CEG/LEG Series Magnetic Circuit Protectors



| | | |
|----------------------------------|---|------------|
| <i>Introduction</i> | • | 99 |
| <i>Poles</i> | • | 100 |
| <i>Handles</i> | • | 103 |
| <i>Configurations</i> | • | 108 |
| <i>Operating Characteristics</i> | • | 110 |
| <i>Delay Curves</i> | • | 111 |
| <i>Specifications</i> | • | 115 |
| <i>Decision Tables</i> | • | 117 |





AIRPAX® | IAG/IUG/IEG/CEG/LEG Series Hydraulic Magnetic Circuit Protectors

INTRODUCTION

The Airpax™ IAG/IUG/IEG/CEG/LEG magnetic circuit protectors provide low-cost power switching, reliable circuit protection and accurate circuit control for equipment in the international marketplace.

IEG models meet IEC spacing requirements which is mandatory for equipment that must comply with IEC specifications 601 and 950 and VDE specifications 0804 and 0805. In addition, they are UL Recognized as supplementary protectors per UL STD. 1077, CSA Certified as supplementary protectors per CSA C22.2–No. 235, VDE Approved to VDE 0642 (EN60934), CCC Approved and CE Compliant. IAG models are for those applications where the unit's inherent attributes are desired, but compliance with the various standards is not required.

Designed using the latest in sensitive hydraulic magnetic technology, the IAG/IUG/IEG/CEG/LEG line adapts itself to many applications and environments. They're ideal for data processing and business machines, medical instrumentation, broadcast

equipment, vending and amusement machines, military applications and wherever precision operation is required. Temperature differences which affect fuses and other thermal devices are not a concern.

One important feature of this protector line is a "trip free" action, which means the circuit will trip in the presence of an overload even though the handle is held in the ON position. The delay mechanism senses the fault and the contacts open.

The IAG/IUG/IEG/CEG/LEG is available in a wide variety of configurations including series, series with auxiliary switch, shunt and relay with a choice of delays and ratings in either DC, 50/60Hz or 400Hz versions. Handles come in seven different colors and international markings are standard. Single or multi-pole versions are available, with a variety of pole arrangements to meet your specifications. Four pole models require a double toggle handle. Units with a handle per pole come in one through six pole assemblies.

SINGLE POLE CIRCUIT PROTECTOR

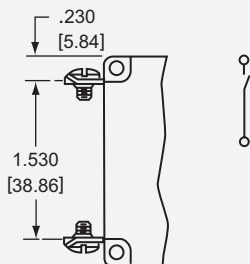
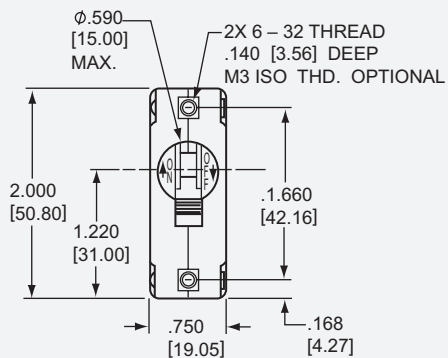
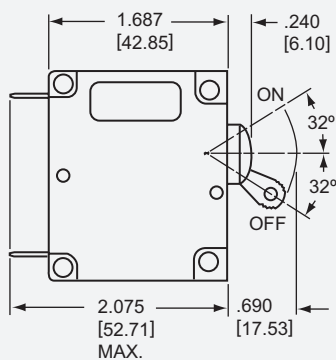

Note: Tolerance $\pm .015$ [.38] unless noted.
 Dimensions in brackets [] are millimeters.
 LEG Type Units Require Screw Terminals

Single Pole Mounting Detail

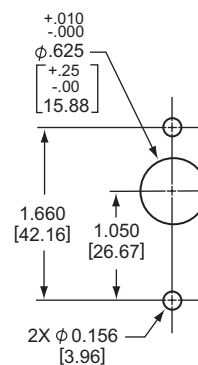

MULTI-POLE CIRCUIT PROTECTORS (IAG/IUG/IEG/CEG/LEG)

Two Pole Protectors

An assembly consisting of two single pole units, having their trip mechanisms internally coupled and with a single toggle handle, forms the IEG11 with quick-connect D.I.N.-style terminals. Individual poles may differ in ratings, delays and internal connections. An auxiliary switch may be included in either or both poles, allowing you to mix SELV and hazardous voltages. Rugged screw-type terminals can be provided, in which case the designation would be IEG66. The IEGH offers a toggle handle for each pole. LEG type units are available only in one or two pole configurations.

Three Pole and Four Pole Protectors

The three pole construction consists of three single pole units assembled with an internal mechanical interlock which actuates

all units simultaneously. A single toggle handle operates all three poles for quick and convenient control, or if preferred, a handle per pole is available. The four pole construction consists of four single pole units assembled with an internal mechanical interlock which actuates all units simultaneously. A double toggle handle operates all four poles. The individual poles need not have identical characteristics and any series trip pole may have an auxiliary switch. If screw-type terminals are required, the breaker designation will be IEG666 for a three pole version and IEG6666 for a four pole version.

Protector poles are numbered consecutively when viewed from the terminal side, with the ON position up, starting with Pole #1 on the left side and proceeding to the right.

IAG/IUG/IEG/CEG/LEG Multi-Pole Circuit Breakers

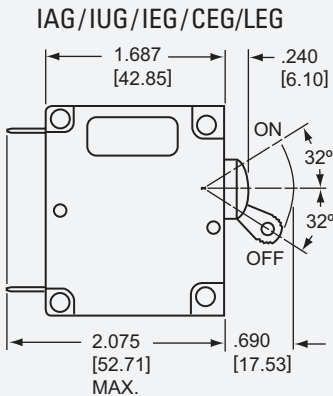

Two Pole*

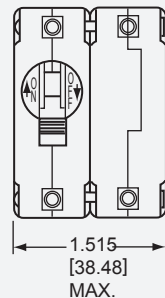

Three Pole*

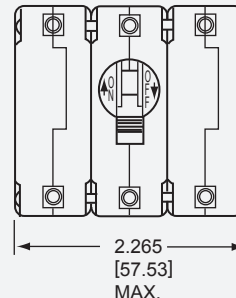

Four Pole*

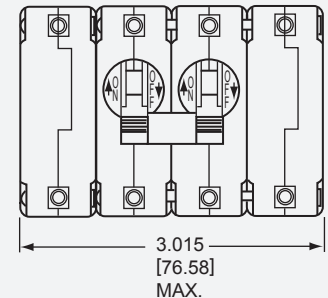

(Optional: Handle may be located in Pole 1 instead of Pole 2)

LEG Type Units Require Screw Terminals

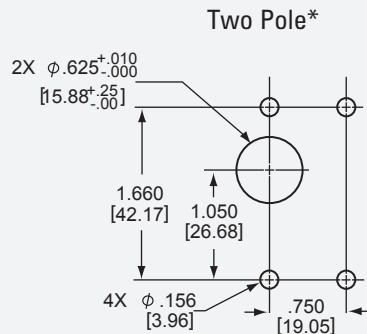
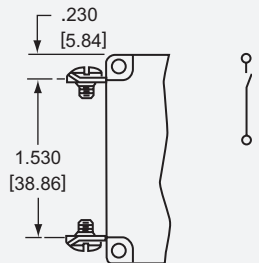

Three Pole*

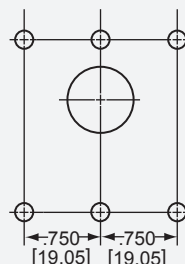

Four Pole*

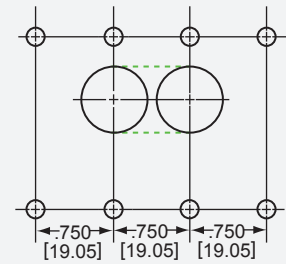

Panel Mounting Detail: Tolerance for Mtg. $\pm .005$ [.13] unless noted.
*See Single Pole Mounting Detail for hole sizes and locations. LEG type units are only available in one or two poles.

Note: Tolerance $\pm .015$ [.38] unless noted. Dimensions in brackets [] are millimeters.

MULTI-POLE CIRCUIT PROTECTORS (IAGH/IUGH/IEGH/CEGH/LEGH)

The IAGH/IUGH/IEGH/CEGH/LEGH two, three and four pole models are available with a handle per pole. LEGH type units are available only in two pole models.

IAGH/IUGH/IEGH/CEGH/LEGH Protectors

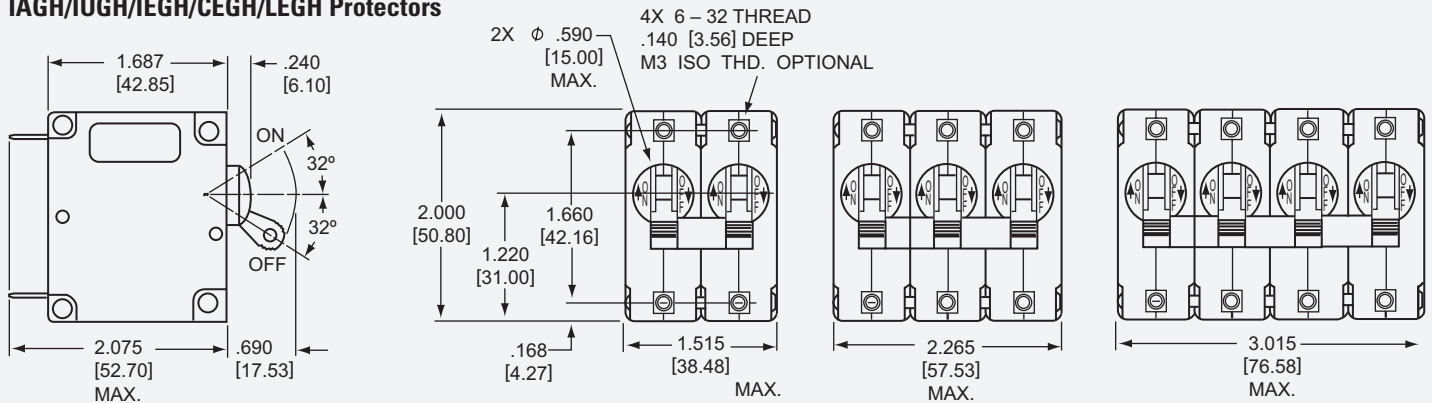

LEG (Requires Screw Terminals)

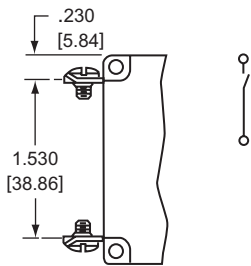

Two Pole

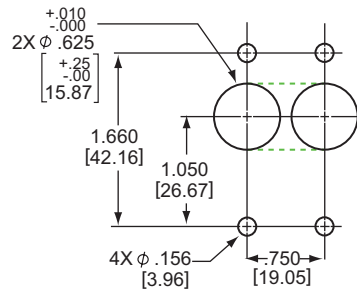

Three Pole*

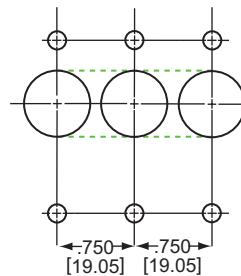

Four Pole*

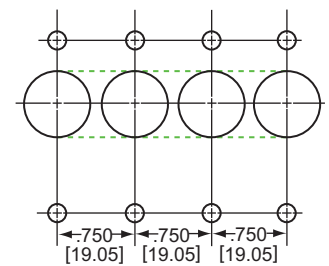

*See Two Pole Mounting Detail for hole sizes and locations.

Panel Mounting Detail: Tolerance for Mtg. ± 0.005 [0.13] unless noted.

NOTE: We recommend machining slots into your panel for 2 or more poles. This eliminates the need to disassemble/reassemble the handle ties to be able to insert the handles thru individually drilled holes. LEG type units are only available in one or two poles.

LEG/LEGH Barriers (required)

In order to meet UL listing requirements, the LEG/LEGH two pole model requires barriers. Available with a standard straight barrier or an optional "Z" type barrier.

Standard Barrier

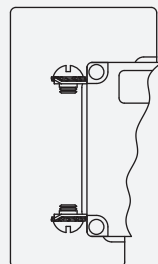
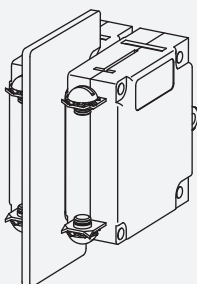

Optional "Z" Barrier

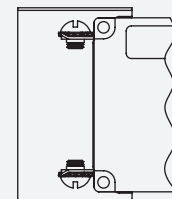
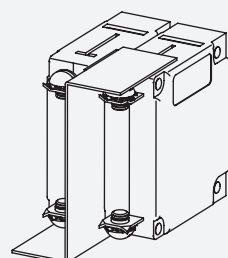

Note: Tolerance ± 0.015 [0.38] unless noted. Dimensions in brackets [] are millimeters.

ROCKER CIRCUIT PROTECTORS (IAGX/IAGZX/IUGX/IUGZX/IEGX/IEGZX/CEGX/CEGZX/LEGZX)

The IAGX/IUGX/IEGX/CEGX and IAGZX/IUGZX/IEGZX/CEGZX/LEGZX styles offer two attractive rocker actuator versions of our popular IAG/IUG/IEG/CEG/LEG family. Designed with the operator in mind, each features handles with a concave surface and aesthetic appearance for front panel applications.

Both are available with rocker handle styles in a choice of five single colors: black, red, grey, orange or white.

The IAGZX/IUGZX/IEGZX/CEGZX/LEGZX style adds our "EZ" options of contrasting dual color rocker actuators, affording a clear visual indication of the handle position and integrated handle guards, to help prevent accidental turn-on and turn-off of the unit. Available with a black rocker and white, red or green indicator color for either ON or OFF indication.

IAGX/IUGX/IEGX/CEGX

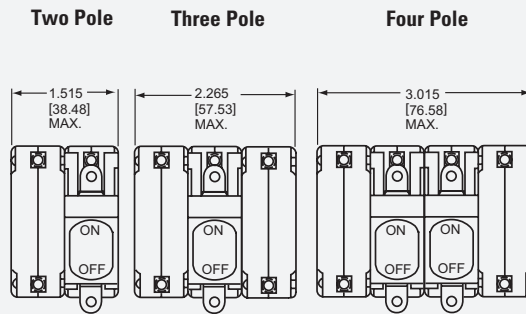
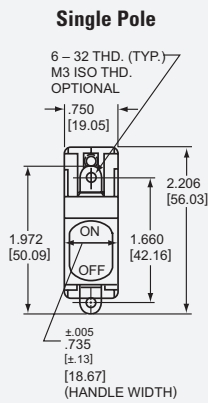
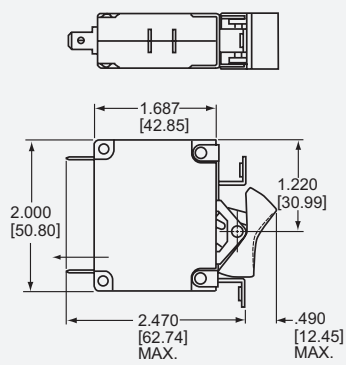

(Optional: Handle may be located in Pole 2 instead of Pole 1)

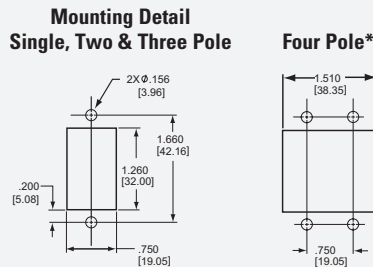

Panel Mounting Detail: Tolerance for mounting $\pm .005$ [0.13] unless noted.
*See Single Pole Mounting Detail for hole sizes and locations.

IAGZX/IUGZX/IEGZX/CEGZX/LEGZX

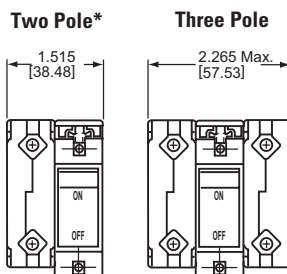
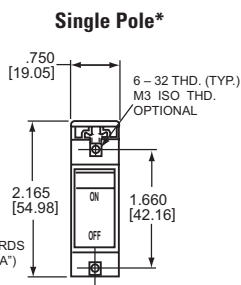
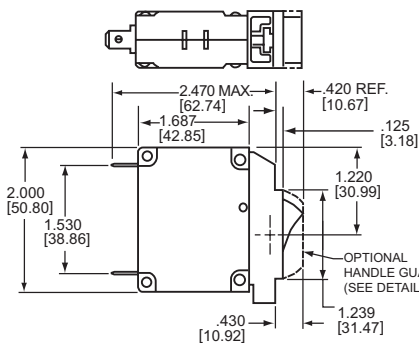

Single, Two & Three Pole

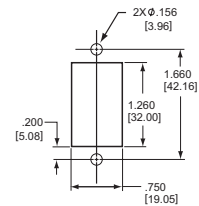

Panel Mounting Detail: Tolerance for Mtg. $\pm .005$ [0.13] unless noted.

Note: Tolerance $\pm .015$ [0.38] unless noted. Dimensions in brackets [] are millimeters.

* LEG type units are only available in one or two poles.

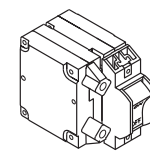

Detail "A"

ROCKER CIRCUIT PROTECTORS (IAGBX/IUGBX/IEGBX/CEGBX/LEGBX)

The innovative new design of our IEG BX style circuit breaker features a flat front rocker that not only satisfies your aesthetic needs, it guards against accidental actuation while providing the highest degree of circuit protection and quality. Only Sensata Technologies offers this new standard in user interface, providing additional peace of mind that guards alone can't supply.

Available on a variety of versions with a full range of agency approvals, the new IEG BX style circuit breakers meet or exceed all current performance specifications, including interrupting capacities up to 50,000 amperes. Various guard options offer additional and increasing levels of actuation protection performance. The two shot mold on the flat rocker surface provides a clean, crisp legend that can withstand demanding use.

IAGBX/IUGBX/IEGBX/CEGBX/LEGBX

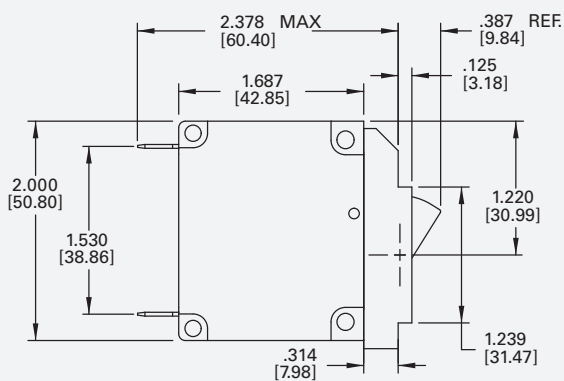
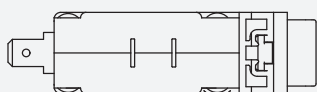

SINGLE POLE

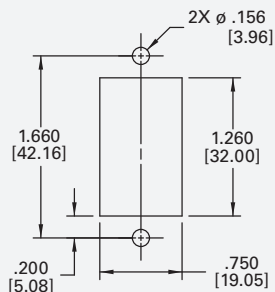
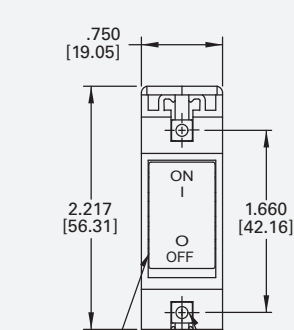

Panel Mounting Detail

MOUNTING DETAIL TOLERANCE:
±.005 [.13] UNLESS NOTED

OPTIONAL
GUARD
(SEE DETAIL "A")

6-32THD. MOUNTING
M3 ISO THD. OPTIONAL

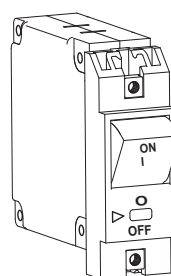

Handle position
"OFF" with guard
(6th decision, G)

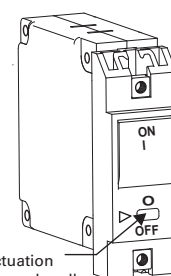

Handle
position "ON"
with guard
(6th decision, G)

Actuation
access handle
(see note)

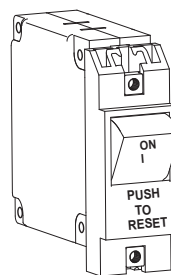

Handle position
"OFF" guard with
no actuate "OFF"
feature
(6th decision, X)

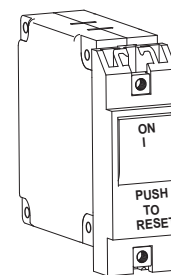

Handle position
"ON" guard with
no actuate "OFF"
feature
(6th decision, X)

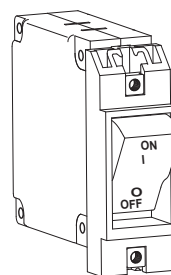

Handle position
"OFF" without
guard

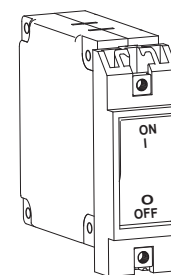

Handle position
"ON" without
guard

DETAIL "A"

Note: Access is limited to a device smaller than the Underwriters Laborator "articulated probe"
Defined in UL-489 FIG. 11.1.7.2.1.

SEALED TOGGLE CIRCUIT PROTECTORS (IAGN/IUGN)

The IAGN/IUGN family is a sealed toggle version of the IAG/IUG family. The silicone rubber seal around the handle assures panel seal integrity and makes this style a natural for harsh environments.

This sealed toggle family is available in one to three poles with ratings of .050 to 50 amperes.

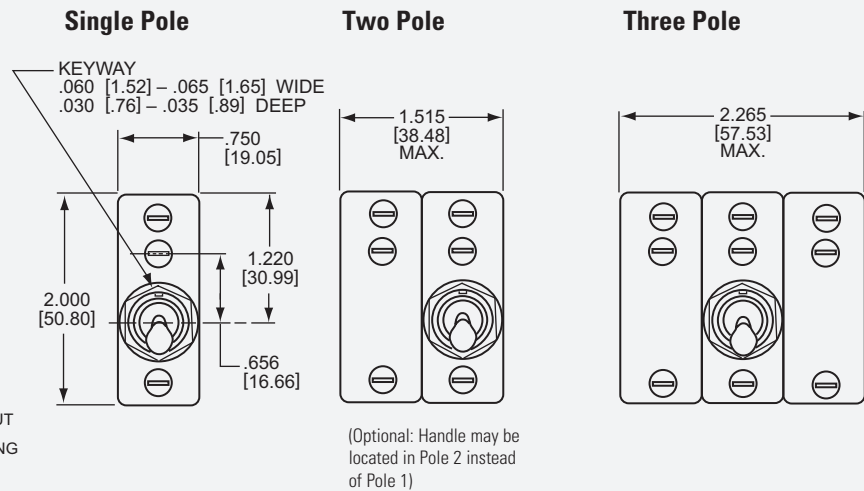
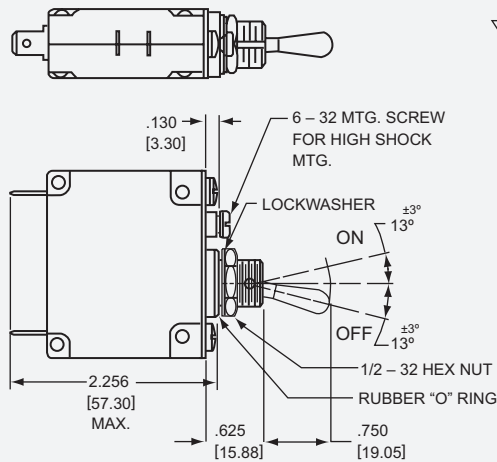

Optional Handle

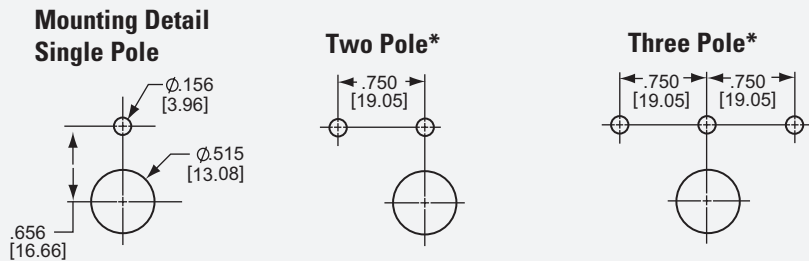
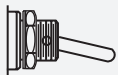

Panel Mounting Detail: Tolerance for Mtg. ±.005 [.13] unless noted.
*See Single Pole Mounting Detail for hole sizes and locations.

Note: Tolerance ± .015 [.38] unless noted. Dimensions in brackets [] are millimeters.

SNAP-IN CIRCUIT PROTECTORS (IEGS/IEGHS/CEGS/CEGHS/LEGS/LEGHS)

The Snap-In version of the IEG brings mounting simplification and international spacing together in a package that is aesthetically enhanced. The IEGS securely snaps into a rectangular cut-out, eliminating the need for panel mounting hardware and the associated costs. The face plate of the IEGS is a clean, black matte and it satisfies the increasing demand for front panel components that are designed with ergonomic considerations.

The IEGS is offered in either flush or beveled versions, in 1, 2, 3 or 4 pole packages, and with a handle per pole or per unit.

The IEGS is UL Recognized, CSA Certified and VDE approved.

IEGHS/CEGHS/LEGHS Circuit Protectors (Note B)

(Multi-Pole-IEGH Handles Per Pole)

(Omit H for Single Pole)

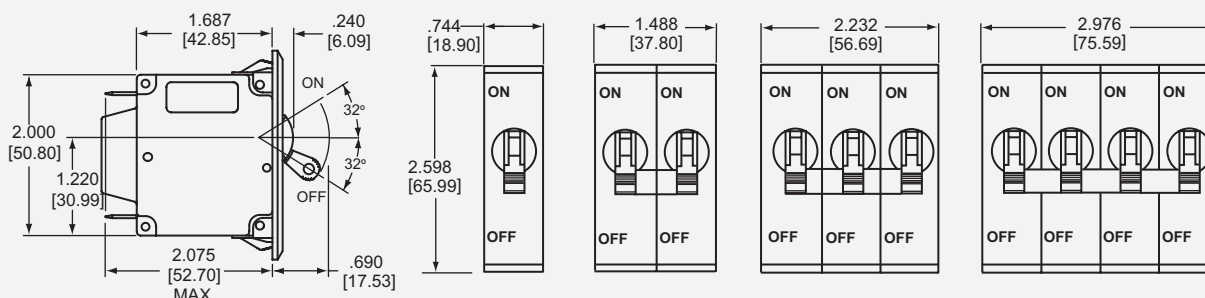

Panel Cutout Detail
Panel Thickness: (See Table)

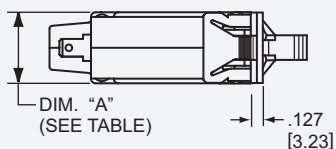

Note:

A: Flush face plate is optional. See decision tables, sixth decision.
B: Tolerance $\pm .031$ [.79] Angles: $\pm 5^\circ$ unless noted. Dimensions in brackets [] are millimeters.

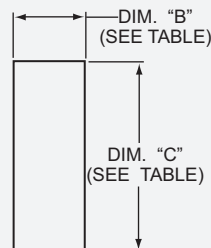

DIMENSIONS "A", "B", "C"

| Number of Poles | Dimension "A", inches [mm] | Dimension "B", inches [mm] | Dimension "C", inches [mm] | |
|------------------------|------------------------------|------------------------------|---------------------------------------|---------------------------------------|
| 1 pole | .750 [19.05] max | .755 [19.18] min | 2.180 \pm .005 [55.37 \pm .13] | 2.186 \pm .011 [55.52 \pm .28] |
| 2 pole | 1.515 [38.48] max | 1.520 [38.61] min | | |
| 3 pole | 2.265 [57.53] max | 2.270 [57.66] min | | |
| 4 pole | 3.015 [76.58] max | 3.020 [76.71] min | | |
| Panel Thickness | | | .040 to .059 [1.02 to 1.50] | .060 to .100 [1.52 to 2.54] |

IEGS/CEGS/LEGS Circuit Protectors (Note B)
(Add H for multiple handles per unit, IEGHS)

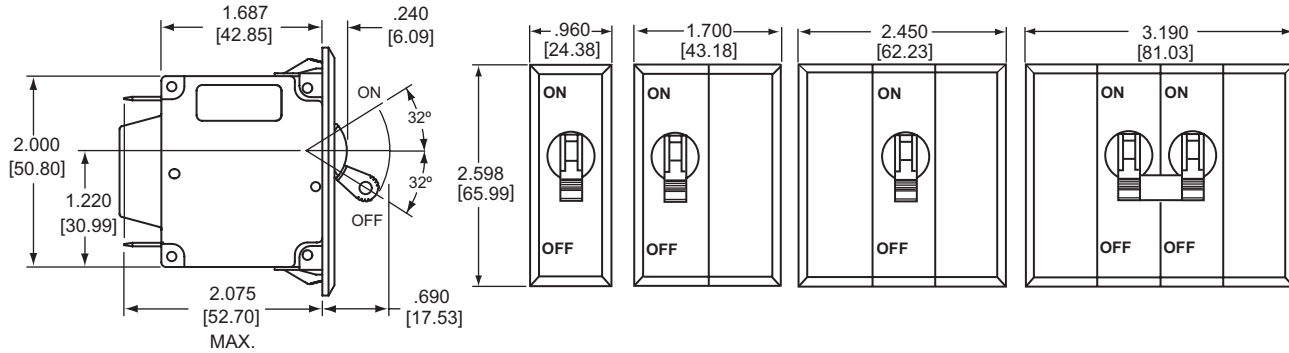

Panel Cutout Detail
Panel Thickness: (See Table)

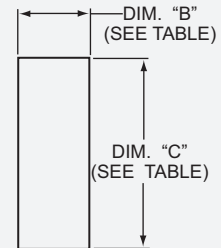
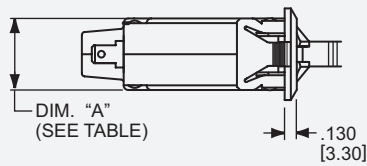

| DIMENSIONS "A", "B", "C" | | | | |
|--------------------------|------------------------------|------------------------------|--------------------------------|--------------------------------|
| Number of Poles | Dimension "A", inches [mm] | Dimension "B", inches [mm] | Dimension "C", inches [mm] | |
| 1 pole | .750 [19.05] max | .780 ± .015 [19.81 ± .381] | 2.180 ± .005 [55.37 ± .13] | 2.186 ± .011 [55.52 ± .28] |
| 2 pole | 1.515 [38.48] max | 1.540 ± .015 [39.12 ± .381] | | |
| 3 pole | 2.265 [57.53] max | 2.290 ± .015 [58.17 ± .381] | | |
| 4 pole | 3.015 [76.58] max | 3.040 ± .015 [77.22 ± .381] | | |
| Panel Thickness | | | .040 to .059 [1.02 to 1.50] | .060 to .100 [1.52 to 2.54] |

Optional Handle Guard

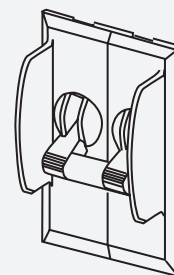
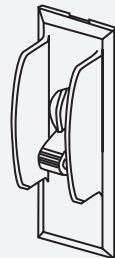
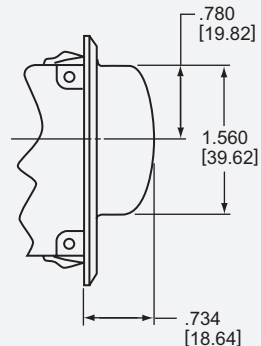

Note: A: Tolerance ± .015 [.38] unless noted. Dimensions in brackets [] are millimeters.
B: Bevelled face plate is standard.

CONFIGURATIONS

Series Trip

The most popular configuration for magnetic protectors is the series trip where the sensing coil and contacts are in series with the load being protected. The handle position conveniently indicates circuit status. In addition to providing conventional overcurrent protection, it's simultaneously used as an on-off switch.

Shunt Trip

The shunt trip is designed for controlling two separate loads with one assembly. The control is established by providing overload protection for the critical load. When the current through this load becomes excessive and reaches the trip point, the protector will open and remove power from both loads simultaneously. The total current rating of both loads must not exceed the maximum contact rating.

Auxiliary Switch (Applies to Series Trip Only)

This is furnished as an integral part of a series pole in single or multi-pole assemblies. Isolated electrically from the protector's circuit, the switch works in unison with the power contacts and provides indication at a remote location of the protector's on-off status.

Auxiliary switch contacts actuate simultaneously with the main protector contacts, and will open regardless of whether the protector contacts are opened manually or electrically. For auxiliary switch ratings below 6Vac or 5Vdc, an auxiliary switch with gold contacts designated as REG is available. Gold contacts are not recommended for load current above 100 milliamps.

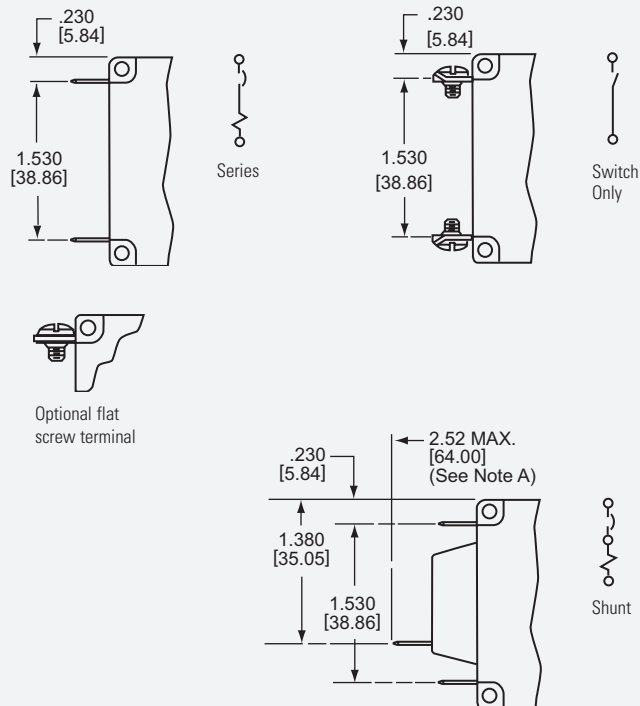

Standard Auxiliary Switch

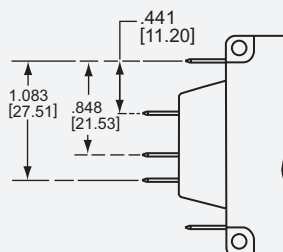

VDE Auxiliary Switch

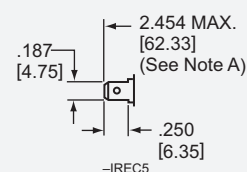
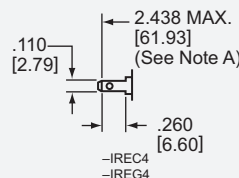
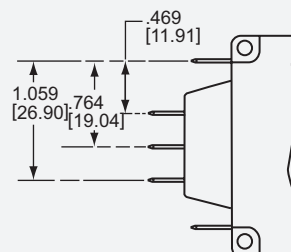

Series with Auxiliary Switch

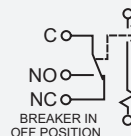

| MAIN TERMINAL TYPES | | | | | |
|---------------------|---------|------------|----------|-------------|----------|
| Amp Rating | Push-On | 8-32 Screw | M4 Screw | 10-32 Screw | M5 Screw |
| .05 to 30 | X | X | X | | |
| 30.1 to 50 | | | | X | X |

Note:

A: Terminal protrusion dimensions are referenced from back mounting panel.

B: Main terminals are male push-on type .250 [6.35] wide x 0.31 [.79] thick x .375 [9.53] long or 8-32 x .187 [4.75] screw type. Metric screw terminals are M4 x 5mm (<=30A); M5 x 5mm screw type (>30A). On VDE approved builds with screw terminals, external tooth lockwashers are supplied. On VDE approved builds with push-on terminals a soldered connection is required above 25 amperes.

Relay Trip

This permits the overload sensing coil to be placed in a circuit which is electrically isolated from the trip contacts. The coil may be actuated by sensors monitoring pressure, flow, temperature, speed, etc. Other typical applications include crowbar, interlock and emergency /rapid shutdown circuitry. Trip may be accomplished by voltage or current, which must be removed after trip.

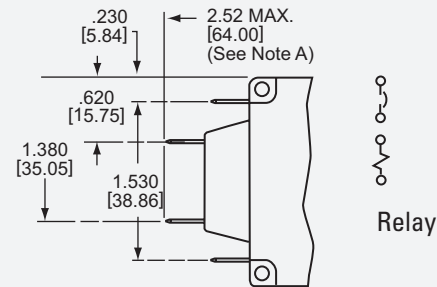

Dual Coil

By combining two electrically independent coils on a common magnetic circuit, it is possible to provide contact opening when either an over-current or trip voltage is applied to the respective coils. One coil will be a current trip coil with standard specifications. The second, or dual coil, can be used to provide a control function permitting contact opening from a remote interlock or other transducer functions. Standard coils are 6, 12, 24, 48, 120 and 240 volts. Tripping is instantaneous and must be removed (usually self-interrupting) after trip.

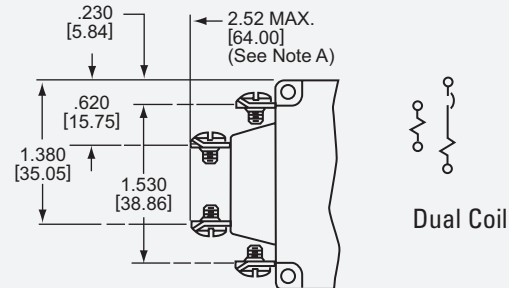
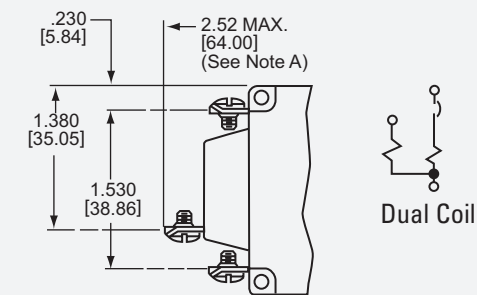

Voltage Trip

Sometimes called "dump circuits" or "panic trip circuits," these units make it possible to open main power contacts with lower power inputs from one or more sources. This configuration is becoming increasingly more important for sensitive circuitry and denser packaging in automation systems. Available in series, shunt or relay configurations.

Optional Barriers (IEG Only)

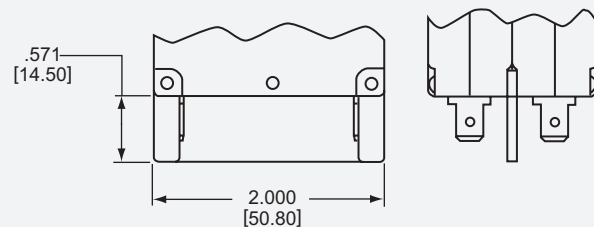

Note: Tolerance $\pm .015$ [.38] unless noted.
Dimensions in brackets [] are millimeters.

TYPICAL RESISTANCE / IMPEDANCE

| Current Ratings (Amps) | Impedance | | |
|---------------------------|----------------|-----------------------|---------------------|
| | DC (ohms) | AC, 50/60Hz (ohms) | AC, 400Hz (ohms) |
| | 51, 52, 53, 59 | 61, 62, 63, 69 | 41, 42, 43, 49 |
| 0.200 | 45.8 | 28.5 | 71.94 |
| 1.00 | 1.38 | 1.10 | 2.85 |
| 2.00 | 0.371 | 0.29 | 0.76 |
| 5.00 | 0.055 | 0.051 | 0.12 |
| 10.0 | 0.017 | 0.016 | 0.032 |
| 20.0 | 0.006 | 0.006 | 0.010 |
| 30.0 | 0.003 | 0.004 | 0.006 |
| 50.0 | 0.0019 | 0.0018 | — |

DCR and Impedance based on 100% rated current applied and stabilized for a minimum of one hour. Tolerance .05-2.5 amperes \pm 20%; 2.6 -20 amperes \pm 25%, 21-50 amperes \pm 50%. Consult factory for special values and for coil impedance of delays not shown.

OPERATING CHARACTERISTICS

Inrush Pulse Tolerance

The following table provides a comparison of inrush pulse tolerance with and without the inertial delay feature for each of the 50/60Hz delays. Pulse tolerance is defined as a single pulse of half sine wave peak current amplitude of 8 milliseconds duration that will not trip the circuit breaker. The table at left provides a guide to determine if the inertia delay feature is required. Consult factory for further assistance.

INRUSH PULSE TOLERANCE

| Delay | Pulse Tolerance |
|------------------------------|---------------------------------|
| 61, 62, 63, 71, 72, 73 | 10 times rated current (approx) |
| 61F, 62F, 63F, 71F, 72F, 73F | 12 times rated current (approx) |
| 64, 65, 66 | 25 times rated current (approx) |

PERCENTAGE OF RATED CURRENT VS TRIP TIME IN SECONDS

| Delay | 100% | 125% | 150% | 200% | 400% | 600% | 800% | 1000% |
|-------|---------|-------------|-------------|-------------|--------------|-------------|-------------|-------------|
| 41 | No Trip | May Trip | .500 to 8.0 | .150 to 1.9 | .020 to .40 | .006 to .25 | .004 to .1 | .004 to .05 |
| 42 | No Trip | May Trip | 5 to 70 | 2.2 to 25 | .40 to 5.0 | .012 to 2 | .006 to .2 | .006 to .15 |
| 43 | No Trip | May Trip | 35 to 350 | 12 to 120 | 1.5 to 20 | .012 to 2.2 | .01 to .22 | .01 to .1 |
| 49 | No Trip | May Trip | .100 Max | .050 Max | .020 Max | .020 Max | .020 Max | .020 Max |
| 51* | No Trip | .500 to 6.5 | .300 to 3.0 | .100 to 1.2 | .031 to .500 | .011 to .25 | .004 to .1 | .004 to .08 |
| 52* | No Trip | 2 to 60 | 1.8 to 30 | 1 to 10 | .15 to 2.0 | .04 to 1 | .008 to .5 | .006 to .1 |
| 53* | No Trip | 80 to 700 | 40 to 400 | 15 to 150 | 2 to 20 | .23 to 9 | .018 to .55 | .012 to .2 |
| 59* | No Trip | .120 Max | .050 Max | .050 Max | .022 Max | .017 Max | .017 Max | .017 Max |
| 61* | No Trip | .700 to 12 | .35 to 7.0 | .130 to 3.0 | .030 to 1 | .015 to .3 | .01 to .15 | .008 to .1 |
| 62* | No Trip | 10 to 120 | 6 to 60 | 2 to 20 | .2 to 3.0 | .02 to 2 | .015 to .8 | .01 to .25 |
| 63* | No Trip | 50 to 700 | 30 to 400 | 10 to 150 | 1.5 to 20 | .4 to 10 | .013 to .85 | .013 to .5 |
| 64 | No Trip | .7 to 12 | .35 to 7 | .13 to 3 | .030 to 1 | .017 to .3 | .01 to .16 | .008 to .1 |
| 65 | No Trip | 10 to 120 | 6 to 60 | 2 to 20 | .2 to 3 | .02 to 2 | .017 to .76 | .01 to .6 |
| 66 | No Trip | 50 to 700 | 30 to 400 | 10 to 150 | 1.5 to 20 | .4 to 10 | .014 to 5 | .014 to 3 |
| 69* | No Trip | .120 Max | .100 Max | .050 Max | .022 Max | .017 Max | .017 Max | .017 Max |
| 71** | No Trip | .440 to 10 | .300 to 7 | .100 to 3.0 | .03 to 1 | .012 to .3 | .004 to .15 | .004 to .1 |
| 72** | No Trip | 1.8 to 100 | 1.7 to 60 | 1 to 20 | .15 to 3 | .04 to 2 | .008 to .79 | .006 to .28 |
| 73** | No Trip | 50 to 600 | 30 to 400 | 10 to 150 | 1.8 to 20 | .22 to 10 | .018 to .88 | .011 to .50 |
| 79** | No Trip | .120 Max | .100 Max | .050 Max | .023 Max | .016 Max | .015 Max | .015 Max |

*CEG type units are available only with 51, 52, 53 and 59 delays LEG type units are available only with 61, 62, 63 and 69 delays

**135% minimum trip point for delays 71, 72, 73 and 79

DELAY CURVES (IAG/IUG/IEG/CEG/LEG)

400Hz, DC, 50/60Hz Delay Curves (typ)

A choice of delays is offered for DC, 50/60Hz and 400Hz applications. Delays 49, 59 and 69 provide fast acting, instantaneous trip and are often used to protect sensitive electronic equipment (not recommended where known inrush exists). Delays 41, 51 and 61 have a short delay for general purpose applications. Delays 42, 52 and 62 are long enough to start certain types of motors and most transformer and capacitor loads. Delays 43, 53 and 63 are long delays for special motor applications at 400Hz, DC and 60Hz. CEG type units are only available in 51, 52, 53 and 59 delay curves. LEG type units are only available in 61, 62, 63 and 69 delay curves.

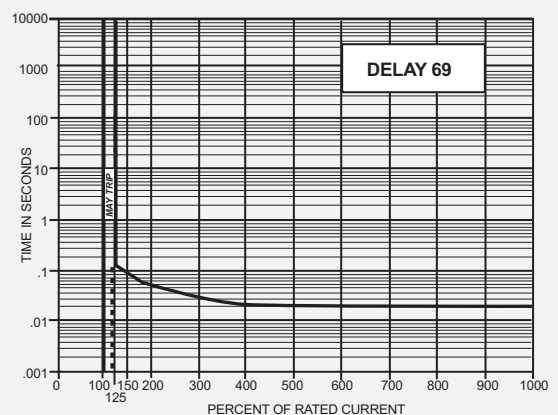
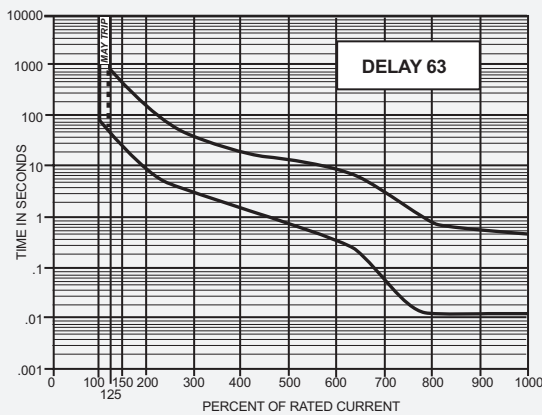
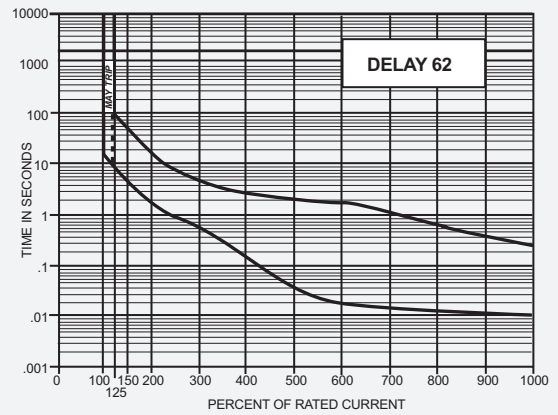
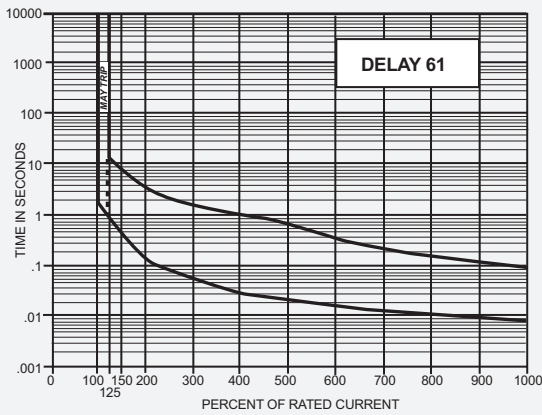

DELAY CURVES (IAG/IUG/IEG/CEG)

DC Delay Curves (typ)

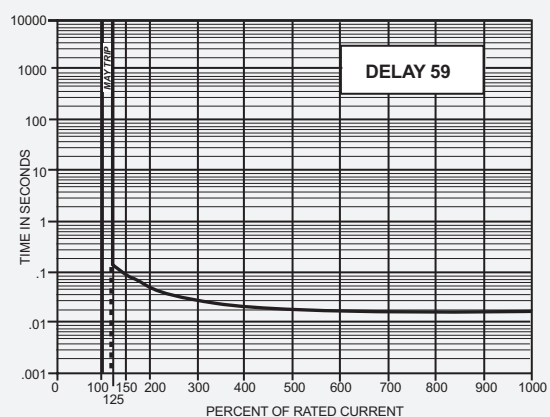
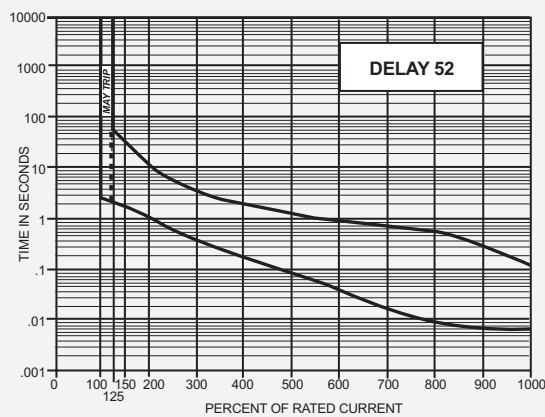
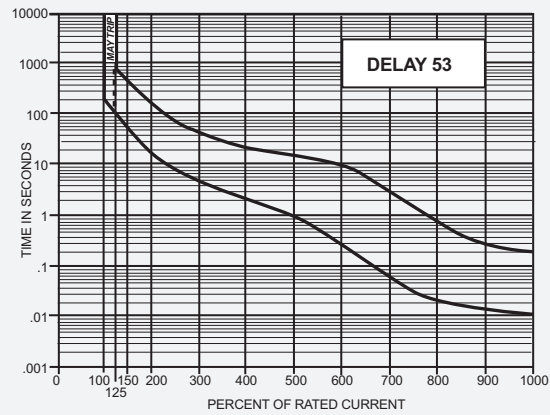
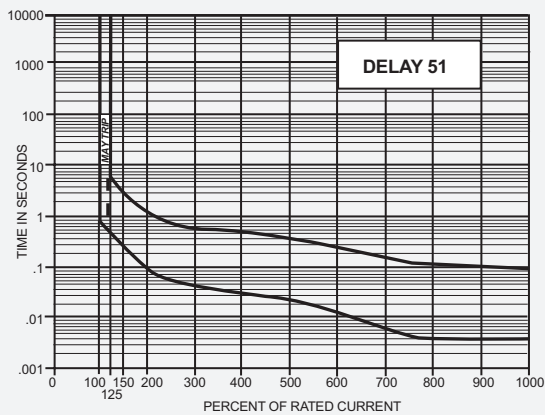

DELAY CURVES (IAG/IUG/IEG)

Multi-frequency - DC, 50/60Hz Delay Curves (typ)

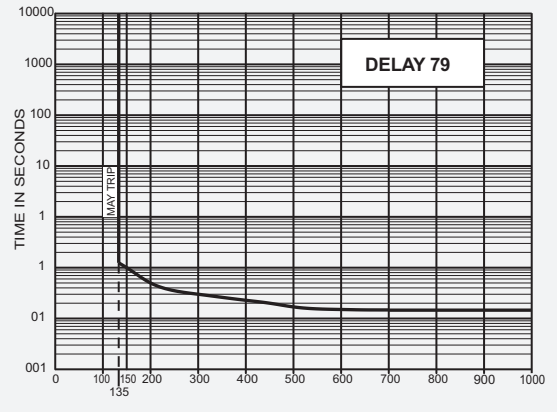
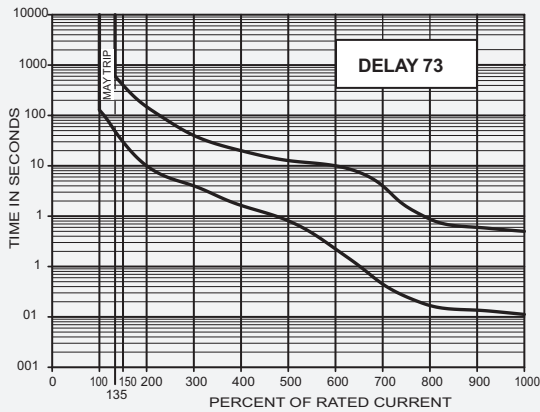
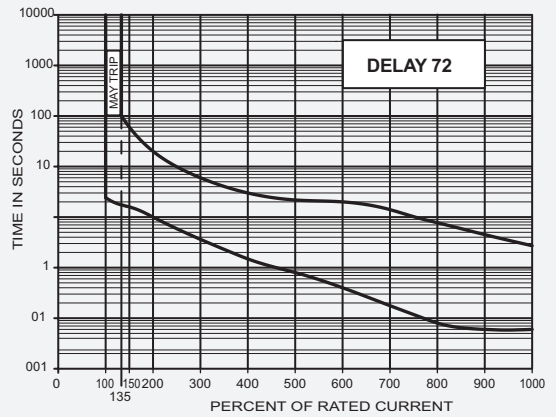
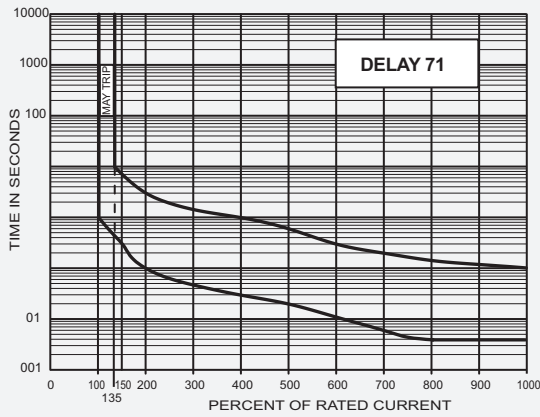

DELAY CURVES (IAG/IUG/IEG)

400Hz Delay Curves (typ)

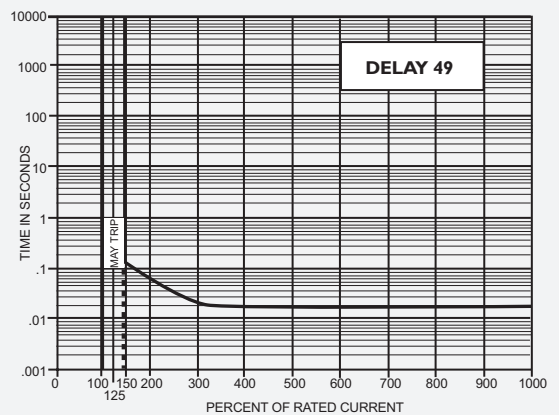
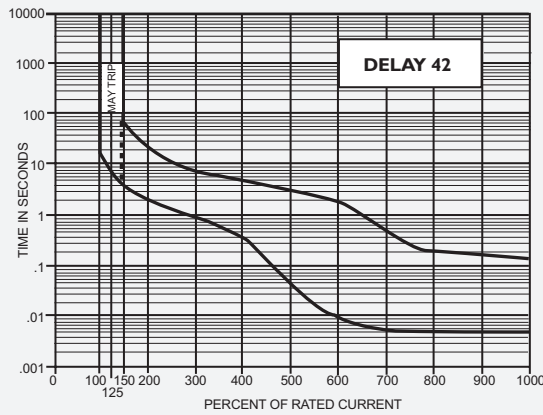
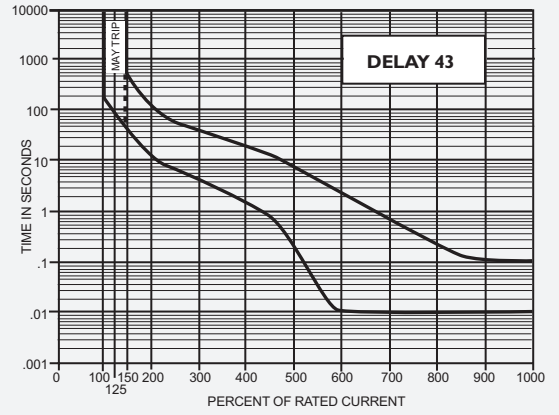
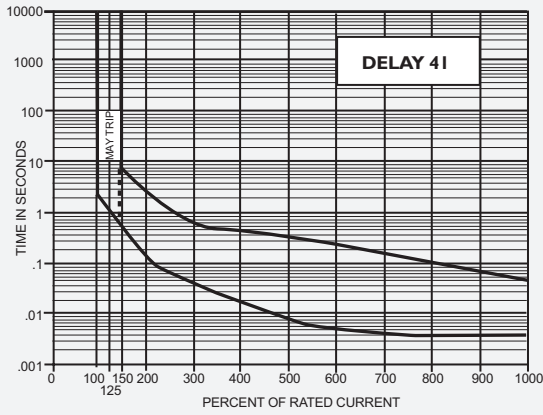

SPECIFICATIONS

Trip Free

Will trip open on overload, even when forcibly held in the ON position. This prevents the operator from damaging the circuit by holding on the protector.

Trip Indication

The operating handle moves positively to the OFF position on overload.

Ambient Operation

IAG/IUG/IEG/CEG/LEG protectors operate in temperatures between -40°C to $+85^{\circ}\text{C}$.

Insulation Resistance

Not less than 100 megohms at 500 volts DC.

Dielectric Strength

IAG/IUG/IEG/CEG/LEG protectors withstand 3750Vac, 60Hz for 60 seconds between all electrically isolated terminals, except auxiliary switch terminals shall withstand 600Vac, 60Hz for REG and REC types. Four terminal dual coil and relay construction (not offered in the IEG) will withstand 1500Vac.

Endurance

Operating as a switch, the operating life exceeds 10,000 operations at a rate of 6 per minute when tested as follows: 6000 OPS @ rated current plus 4000 OPS @ at no load.

Electrical Characteristics

.050-50 amperes; 80Vdc Max., 240Vac Max., 50/60Hz and .050-30 amperes: 250Vac Max., 400Hz. Units above 30 amps are not suitable for cross-the-line motor starting.

Auxiliary Switch

When supplied shall be SPDT configuration. Non VDE approved switches have a maximum UL rating of 10.0 amperes, 250 volts, 60Hz; 3.0 amperes, 50 volts DC, 1 amperes, 80 volts DC (REC) type or 0.1 amperes, 125 volts, 60Hz. (REG type).

VDE approved switches have a maximum UL rating of 10.0 amperes, 250 volts, 60Hz, 1 amperes, 80 volts DC (REG type); or 0.1 amperes, 125 volts, 60Hz (REG type); or 0.1 amperes, 125 volts, 60Hz (REG type).

Moisture Resistance

Meets all the requirements of MIL-PRF-55629 when tested in accordance with Method 106 of MIL-STD-202.

Salt Spray (Corrosion)

Meets the requirements of MIL-PRF-55629 when tested in accordance with Method 101 of MIL-STD-202.

Shock

Circuit protectors shall not trip when tested per MIL-STD-202, Method 213, Test Condition I with 100% rated current applied to delayed units, except 90% current in plane 4 (i.e., handle down). Instantaneous units shall have 80% rated current applied in all planes.

Construction

Series, shunt, relay and series with auxiliary switch available in various delays and combinations.

Vibration

Circuit protector shall not trip when vibrated per MIL-STD-202, Method 204, Test Condition A with 100% rated current applied to delayed units and 80% rated current to instantaneous units.

VDE Approval

IEG is VDE approved under VDE 0642 (EN60934). The IEG has 8mm creepage and clearance between the main circuit and the following areas:

- A. Operator accessible area around the handle.
- B. The mounting inserts or brackets.
- C. The auxiliary switch circuit.
- D. Between poles.

Care must be taken to maintain spacings at the terminals when wired. The VDE approval for standard terminals is not for use with bare wire. A crimp type lug is required. In addition, all VDE approved units will be in compliance with specific CE Directives. These units will be marked as CE Compliant.

UL1500 (Marine Ignition Protected)

IDG/IDGH is approved for Marine Ignition Protection

UL489A Listed

The CEG is dimensionally the same as the popular IEG, but provides UL listing to UL489A. Available in one to three poles, in series, series with auxiliary switch, shunt, dual coil and voltage trip configurations. As a circuit breaker, the CEG provides communication equipment manufacturers with a UL listed circuit breaker in a very compact package that meets the stringent environmental requirements of today's marketplace. This makes the CEG ideal for switching, transmission and wireless applications.

UL489 Listed

The LEG is dimensionally the same as the popular IEG, but provides UL listing to UL489. Available with one or two poles, in series, series with auxiliary switch, shunt and three-terminal dual coil configurations. As a circuit breaker, the LEG provides equipment manufacturers with a UL listed magnetic hydraulic circuit breaker in the most compact package available on the market.

APPROXIMATE WEIGHT PER POLE (1 TO 6 POLES AVAILABLE)

| Ounces | Grams |
|--------|-------|
| 2.2 | 62.4 |

RECOMMENDED TORQUE SPECIFICATIONS

| Component | Torque (in-lbs) |
|---------------------------|-----------------|
| 6-32 Mounting Inserts | 6 to 8 |
| M3 Mounting Screws | 4 to 5 |
| 8-32 Screw Terminals | 10 to 12 |
| M4 Terminal Screws | 10 to 12 |
| 10-32 Screw Terminals | 14 to 15 |
| M5 Screw Terminals | 14 to 15 |
| 1/2 - 32 Mounting Bushing | 30 to 35 |

Where applicable, mechanical support must be provide to the terminals when applying torque

AGENCY APPROVALS

| IAG/IUG/IEG Supplementary Protectors | | | | Rated Current (Amps) | | Short Circuit Rating (SC), Amps | |
|--------------------------------------|----------------|-------|---------------|----------------------|-----------|---------------------------------|------|
| Max Voltage | Frequency (Hz) | Phase | Minimum Poles | UL/CSA | TÜV | UL1077 & CSA | TÜV |
| 80 | DC | — | 1 | .02 to 50 | .10 to 30 | U2, 7500 | 4000 |
| 125 | 50/60 | 1 | 1 | .02 to 50 | — | U2, 3000 | — |
| 125 | 50/60 | 1 | 1 | .02 to 30 | — | C1, 5000(3) | — |
| 125 | 50/60 | 1 | 1 | .02 to 50 | — | U3, 1000 | — |
| 125 / 250 | 50/60 | 1 | 2 | .02 to 50 | — | U1, 3000 | — |
| 125 / 250 | 50/60 | 1 | 1 | 2/1 - 30/15 | — | C2, 5000(1) | — |
| 240 | 50/60 | 1 & 3 | 1 | .02 to 50 | — | U1, 2000 | — |
| 240 | 50/60 | 1 & 3 | 1 | .02 to 50 | — | C2, 5000(1) | — |
| 250 | 50/60 | 1 | 1 | .02 to 2 | — | U2, 5000 | — |
| 250 | 50/60 | 1 & 3 | 1 | .02 to 30 | .10 to 50 | U1, 2000 | 2000 |
| 250 | 50/60 | 1 & 3 | 1 | .02 to 30 | — | C2, 3500(2) | — |
| 250 (4) | 50/60 | 1 & 3 | 1 | .02 to 30 | — | C1, 3500(2) | — |
| 250 (4) | 50/60 | 1 & 3 | 1 | .02 to 30 | — | U1, 1000 | — |
| 250 (5) | 50/60 | 1 | 2 | .02 to 50 | — | U3, 1000 | — |
| 250 (5) | 50/60 | 3 | 3 | .02 to 50 | — | U3, 1000 | — |
| 277 | 50/60 | 1 | 1 | .02 to 30 | — | U2, 2000 | — |
| 277 | 50/60 | 1 | 1 | .02 to 30 | — | C2, 5000(2) | — |
| 250 | 400 | 1 & 3 | 1 | .02 to 30 | — | U2, 1500 | — |
| 250 | 400 | 3 | — | .02 to 30 | — | U3, 200 | — |

| IDG Supplementary Protectors | | | | | | | |
|------------------------------|----------------|-------|---------------|--------|-----|--------------|-----|
| Max Voltage | Frequency (Hz) | Phase | Minimum Poles | UL/CSA | TÜV | UL1077 & CSA | TÜV |
| 48 | DC | — | 1 | .02-50 | — | U2, 5000 | — |
| 65 | DC | — | 1 | .02-50 | — | U2, 3000 | — |
| 125 | 50/60 | 1 | 1 | .02-50 | — | U2, 2000 | — |
| 125/250 | 50/60 | 1 | 2 | .02-50 | — | U2, 1500 | — |
| 250 | 50/60 | 1 & 3 | 1 | .02-30 | — | U1, 1000 | — |

| CEG Communications Equipment Circuit Breakers | | | | | | | |
|---|----------------|-------|---------------|--------|-----|--------|-----|
| Max Voltage | Frequency (Hz) | Phase | Minimum Poles | UL/CSA | TÜV | UL489A | TÜV |
| 80 | DC | — | 1 | .05-50 | — | 5000 | — |

| LEG Circuit Breakers | | | | | | | |
|----------------------|----------------|-------|---------------|--------|--------|-------|------|
| Max Voltage | Frequency (Hz) | Phase | Minimum Poles | UL/CSA | TÜV | UL489 | TÜV |
| 125 | 50/60 | 1 | 1 | .05-30 | .10-30 | 5000 | 2000 |
| 120/240 | 50/60 | 1 | 2 | 1-30 | .10-30 | 5000 | 2000 |

Notes: (1) With 125 A max. series fuse; (2) With 80 A max. series fuse; (3) With 50 A max. circuit breaker; (4) With blocked vent construction; (5) Non-standard construction. "Fit for further use" approval

General notes:

All supplementary protectors are of the overcurrent (OC) type
 The family of protectors has been evaluated for end use application for use groups (UG) A, B, C and D
 The terminals (FW) are suitable for factory wiring only (0)
 The maximum voltage ratings for which the protectors have been tested are shown in the chart
 The current is the amperage range that the protectors have been tested
 The tripping current (TC) for all of the protectors is "1" (in the range of 125% to 135% of ampere rating except for the 400Hz protectors which is "2" (more than 135% of ampere rating)
 The overload rating (OL) - designates whether the protector has been tested for general use or motor starting applications.

0 – tested at 1.5 times amp rating for general use
 1 – tested at 6 times AC rating or 10 times DC rating for motor starting
 The short circuit current rating (SC) – The short circuit rating in amperes following a letter and number designating the test conditions and any calibration following the short circuit test is defined below:
 C – Indicates short circuit test was conducted with series overcurrent protection
 U – Indicates short circuit test was conducted without series overcurrent protection
 1 – Indicates a recalibration was not conducted as part of the short circuit testing
 2 – Indicates a recalibration was performed as part of the short circuit testing
 3 – Indicates recalibration was performed along with the dielectric and voltage withstand for "Suitable for Further Use" rating

IAG/IUG/IEG/CEG DECISION TABLES

The ordering code for IAG/IUG/IEG/CEG/IDG circuit protectors may be determined by following the decision steps in the tables shown here.

The coding given permits a self-assigning part number but with certain limitations. Special applications may require a factory-assigned part number. Typical examples are units with mixed ratings, combinations of styles, or constructions not listed in the third decision table. With these, it is suggested that order entry be by description and/or drawings and a part number will be established. Additionally, it is standard policy to establish a factory-assigned part number whenever a descriptive drawing exists to provide cross reference, traceability and manufacturing control.

When specifying a circuit protector for AC motor start or high inrush applications, the peak amplitude and surge duration should be specified for factory assistance in rating selection.

For example, the following is the code for a single pole, IEG quick-connect type terminal, series unit with auxiliary switch, designed for operation in a 50/60Hz circuit. It has a short time delay, a rating of 20 amperes, a black marked handle and is VDE approved.

To determine the ordering number for your particular IAG/IUG/IEG/CEG unit, simply follow the steps shown. You may use this number to place an order or as a reference for further questions you may have.

Notes:

- A. It is recommended that power leads be soldered to circuit protectors having push-on type terminals for current trip ratings above 20 amperes.
- B. When "A" (metric thread mounting) is specified in the sixth decision in combination with screw terminal option in the second decision, metric screw terminals are supplied.
- C. IEG, IEGH, IEGS, IEGHS, IEGX and IEGZX circuit protectors are designed to meet 8mm creepage and clearance requirements for installation Category III, Pollution Degree 3, Case A as measured in IEC 664. Intended for use in equipment designed to comply with IEC 601 and 950 and VDE 0804 and 0805.

1 First Decision

Select Type and Terminal

| Type | Description | Handle and Mounting Options |
|--|--|---|
| IAG IUG* IEG** CUG+ CEG++ | One toggle handle per unit | Standard toggle/mounting, no designation required |
| IAGH IUGH* IEGH** CUGH+ CEGH++ | One toggle handle per pole | S Toggle w/ snap-in mounting X Rocker w/ standard mounting* ZX ZX Rocker w/ integral mounting* BX BX Rocker w/ integral mounting N Sealed toggle w/bushing mounting** |
| IDG*** | One toggle handle per unit, marine ignition protection | |
| IDGH*** | One toggle handle per pole marine ignition protection | |
| IMG** CMG++ | One toggle handle per unit mid-trip indication | |
| IMGH** CMGH++ | One toggle handle per pole mid-trip indication | |

*UL Recognized, CSA Certified
**UL Recognized, CSA Certified, VDE Approved
***UL Recognized UL1500
+UL489A Listed CSA Certified
++UL489A Listed CSA Certified VDE Approved

Note: Add "F" for flat screw terminals
* Not available on mid-trip units
** Available only on IAG, IUG units

2 Second Decision

Poles and Terminals

| Push-on Terminals | Screw Terminals | |
|-------------------|-----------------|-------------|
| 1 | 6 | Single pole |
| 11 | 66 | Two pole |
| 111 | 666 | Three pole |
| 1111 | 6666 | Four pole |

*Not available in toggle seal handle type.

Example:

1
2
3
4
5
6
7

IEG 1 - 1REC4 - 61 - 20.0 - 01 - V

3 Third Decision

Internal Configuration

| | |
|--------|--|
| -0 | Switch only |
| -1 | Series |
| -1REC4 | Series w/ auxiliary switch * .110 quick connect |
| -1REC5 | Series w/ auxiliary switch * .187 quick connect |
| -1REG4 | Series w/ auxiliary switch (gold contacts)* .110 quick connect |
| -1RS4 | Series w/ alarm switch, electrical trip, .110 Q.C. terminals |
| -1RLS4 | Series w/ alarm switch, electrical trip, .110 Q.C. terminals (mid-trip only) |
| -3 | Shunt |
| -4 | Relay |

* Only one auxiliary switch is normally supplied on two or three pole units. Switch is located in the right-hand pole (viewed from terminal end) unless otherwise specified.

4 Fourth Decision

Frequency and Delay

| | |
|-----|----------------------------|
| SW | Switch only |
| -41 | 400Hz short delay |
| -42 | 400Hz long delay |
| -43 | 400Hz motor start |
| -49 | 400Hz 150% instant trip |
| -51 | DC short delay* |
| -52 | DC long delay* |
| -53 | DC motor start* |
| -59 | DC 125% instant trip* |
| -61 | 50/60Hz short delay |
| -62 | 50/60Hz long delay |
| -63 | 50/60Hz motor start |
| -64 | 50/60Hz short delay |
| -65 | 50/60Hz long delay |
| -66 | 50/60Hz motor start |
| -69 | 50/60Hz 125% instant trip |
| -71 | DC/60Hz short delay |
| -72 | DC/60Hz long delay |
| -73 | DC/60Hz motor start |
| -79 | DC/60 Hz 135% instant trip |

For addition of inertial delay, add an IFI to any delay numeral.
* CEG types are only available with DC ratings

C = CCC Approved

This approval requires the addition of a C at the end of the part number. The unit will not be VDE Approved.

V = VDE and CCC Approved

The shaded areas denote VDE and CCC (if applicable) approval options. This approval requires the addition of a V at the end of the part number. The V will be added to any part number formed entirely from shaded decisions. If non-shaded areas are selected, the unit will not be VDE or CCC Approved, but other approvals still apply.

117

IAG Series - Decision Tables

<http://airpax.sensata.com>

5 Fifth Decision

Rated Current

Standard ratings listed. For other ratings, please contact the factory.

| | |
|------|-------|
| .100 | 10.0 |
| .250 | 15.0 |
| .500 | 20.0 |
| .750 | 30.0 |
| 1.00 | 35.0* |
| 2.50 | 40.0* |
| 5.00 | 50.0* |
| 7.50 | |

* IDG/IDGH is rated for 30 amps max.

6 Sixth Decision

Optional

Standard hardware. No designation required.

| | |
|----|--|
| -A | Metric thread mounting inserts and terminals |
| -B | Barriers* |
| -C | 277V (50/60Hz only) (See note 3) |
| -G | Handle guard, (available in ZX, BX and snap-in versions only) |
| -L | Handle lock |
| -M | Handle in opposite pole (2 pole only) |
| -Q | APG style "FAT" handle |
| -S | Face plate sides flush with protector (see note 4) |
| -X | Handle guard with no actuation feature (BX rocker only) (Not available with mid-trip indication) |

Notes:
 1. One or more descriptions may be used as required.
 2. When this is not used, table one may be substituted and U.S. thread will be supplied. Unit will be rated at 250V (50/60Hz only).
 3. VDE approved at 250VAC
 4. IEGS standard face plate has beveled sides(see pg.90)
 * Not available on snap-in units

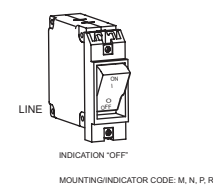
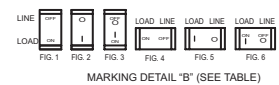
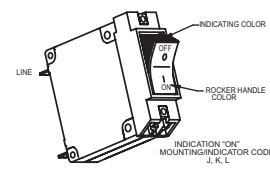
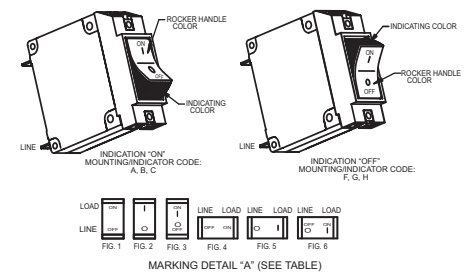

7 Seventh Decision

Handle Color and Marking Selection

Toggle Handle

| Color | Unmarked | Marked ON-OFF I-O |
|--------|----------|-------------------|
| Black | -00 | -01 (STD) |
| Yellow | -10 | -11 |
| Red | -20 | -21 |
| Blue | -30 | -31 |
| Green | -40 | -41 |
| Orange | -60 | -61 |
| White | -90 | -91 |

Handle marking color is white on black, red, blue & green handles and black on white, yellow and orange handles. See alternate 7th decision below for X, ZX & BZ rocker handles.

7 Seventh Decision

Rocker Handle Color, Indicator Color and Marking Selection (See Notes)

| IAGX, IUGX, IEGX, IAGZX, IUGZX, IEGZX, CUGZX, CEGZX Rocker Handle (Single Rocker Color) | | | | | Vertical Mounting | | | Horizontal Mounting | | | Marking Detail |
|---|------------------|---------------|------------|----------|-------------------|-----------|------------------|---------------------|-----------|------------------|----------------|
| Rocker Handle Color | Indicating Color | Marking Color | Indicates: | Unmarked | On-Off Fig.1 | I-O Fig.2 | On-Off I-O Fig.3 | On-Off Fig.4 | I-O Fig.5 | On-Off I-O Fig.6 | |
| Black | N/A | White | N/A | -00 | -01 | -02 | -03 | -04 | -05 | -06 | A |
| Red | N/A | White | N/A | -20 | -21 | -22 | -23 | -24 | -25 | -26 | |
| Grey | N/A | Black | N/A | -40 | -41 | -42 | -43 | -44 | -45 | -46 | |
| Orange | N/A | Black | N/A | -50 | -51 | -52 | -53 | -54 | -55 | -56 | |
| White | N/A | Black | N/A | -90 | -91 | -92 | -93 | -94 | -95 | -96 | |
| IAGZX, IUGZX, IEGZX, CUGZX, CEGZX Rocker Handle (Dual Rocker Color) | | | | | | | | | | | |
| Black | White | White | On | -A0 | -A1 | -A2 | -A3 | -A4 | -A5 | -A6 | A |
| Black | Red | White | On | -B0 | -B1 | -B2 | -B3 | -B4 | -B5 | -B6 | |
| Black | Green | White | On | -C0 | -C1 | -C2 | -C3 | -C4 | -C5 | -C6 | |
| Black | White | White | Off | -F0 | -F1 | -F2 | -F3 | -F4 | -F5 | -F6 | |
| Black | Red | White | Off | -G0 | -G1 | -G2 | -G3 | -G4 | -G5 | -G6 | |
| Black | Green | White | Off | -H0 | -H1 | -H2 | -H3 | -H4 | -H5 | -H6 | |
| Black | White | White | On | -J0 | -J1 | -J2 | -J3 | -J4 | -J5 | -J6 | B |
| Black | Red | White | On | -K0 | -K1 | -K2 | -K3 | -K4 | -K5 | -K6 | |
| Black | Green | White | On | -L0 | -L1 | -L2 | -L3 | -L4 | -L5 | -L6 | |
| IAGBX, IUGBX, IEGBX, CUGBX, CEGBX Rocker Handle (Dual Rocker Color) | | | | | | | | | | | |
| Black | White | White | Off | -M0 | N/A | -M2 | -M3 | N/A | -M5 | -M6 | C |
| Black | Red | Red | Off | -N0 | N/A | -N2 | -N3 | N/A | -N5 | -N6 | |
| Black | Green | Green | Off | -P0 | N/A | -P2 | -P3 | N/A | -P5 | -P6 | |
| Black | Yellow | Yellow | Off | -R0 | N/A | -R2 | -R3 | N/A | -R5 | -R6 | |

Notes: A. Bezels of IAGBX, IUGBX, IEGBX, CUGBX, CEGBX are black.
 B. Consult factory for other marking options.

LEG DECISION TABLES

The ordering code for LEG circuit breakers may be determined by following the decision steps in the tables shown here.

The coding given permits a self-assigning part number but with certain limitations. Special applications may require a factory-assigned part number. Typical examples are units with mixed ratings, combinations of styles, or constructions not listed in the third decision table. With these, it is suggested that order entry be by description and/or drawings and a part number will be established. Additionally, it is standard policy to establish a factory-assigned part number whenever a descriptive drawing exists to provide cross reference, traceability and manufacturing control.

When specifying a circuit breaker for AC motor start or high inrush applications, the peak amplitude and surge duration should be specified for factory assistance in rating selection.

For example, the following is the code for a single pole, LEG screw type terminal, series unit with auxiliary switch, designed for operation in a 50/60Hz circuit. It has a short time delay, a rating of 20 amperes, a black marked handle and is VDE approved.

To determine the ordering number for your particular LEG unit, simply follow the steps shown. You may use this number to place an order or as a reference for further questions you may have.

Notes:

A. When "A" (metric thread mounting) is specified in the sixth decision in combination with screw terminal option in the second decision, metric screw terminals are supplied.

B. LEG, LEGH, LEGS, LEGHS, LEGZX and LEGBX circuit breakers are designed to meet 8mm creepage and clearance requirements for installation Category III, Pollution Degree 3, Case A as measured in IEC 664. Intended for use in equipment designed to comply with IEC 601 and 950 and VDE 0804 and 0805.

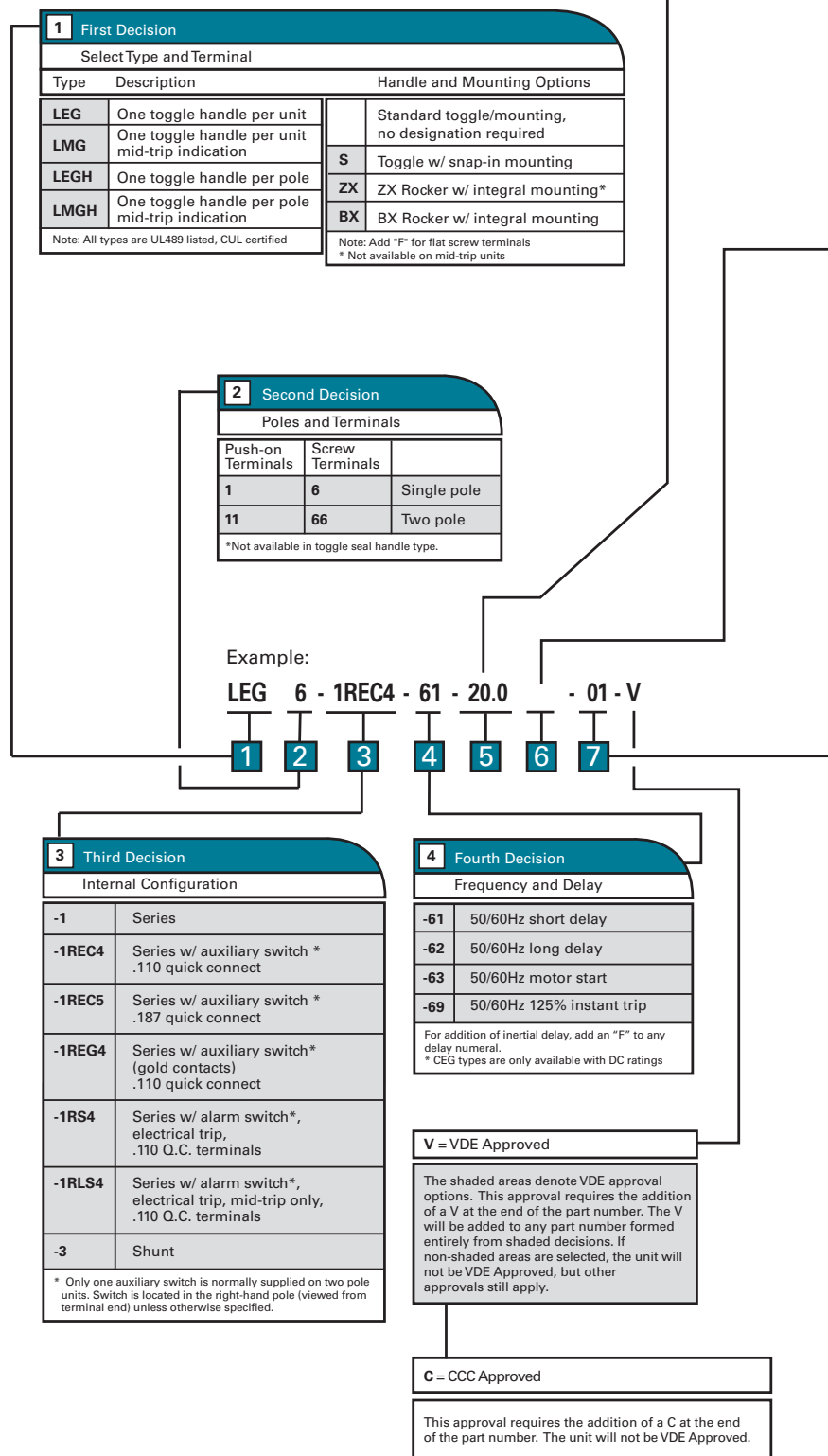

5 Fifth Decision
Rated Current

Use three numbers to print required current value between **.100** amps minimum and **30.0** amps maximum.

For example, use:
 .100 or 2.00 or 10.0

6 Sixth Decision
Optional

| | |
|-----|---|
| | Standard hardware. No designation required. |
| -A | Metric thread mounting inserts and terminals |
| -G | Handle guard, (available in ZX, BX and snap-in versions only) |
| -L | Handle lock |
| -S | Face plate sides flush with breaker |
| -X* | Handle guard with no actuation feature (BX rocker only) |
| -Z | "Z" Barriers |

Notes:
 1. One or more descriptions may be used as required.
 2. When this is not used, table one may be substituted and U.S. thread will be supplied. Unit will be rated at 250V (50/60Hz only.)
 3. LEGS standard face plate has beveled sides(see pg. 90)
 * Not available on mid-trip units

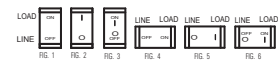
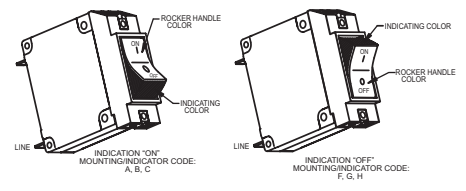

MARKING DETAIL "A"

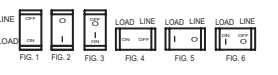
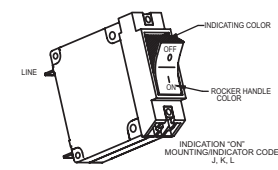

MARKING DETAIL "B"

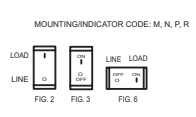
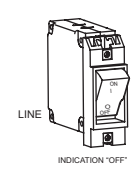

MARKING DETAIL "C"

7 Seventh Decision
Handle Color and Marking Selection

Toggle Handle

| Color | Unmarked | Marked ON-OFF I-O |
|--------|----------|-------------------|
| Black | -00 | -01 (STD) |
| Yellow | -10 | -11 |
| Red | -20 | -21 |
| Blue | -30 | -31 |
| Green | -40 | -41 |
| Orange | -60 | -61 |
| White | -90 | -91 |

Handle marking color is white on black, red, blue & green handles and black on white, yellow and orange handles. See alternate 7th decision below for ZX & BZ rocker handles.

7 Seventh Decision
Rocker Handle Color, Indicator Color and Marking Selection (See Note)

| LEGZX Rocker Handle (Single Rocker Color) | | | | | | | | | | | |
|---|------------------|---------------|------------|----------|-------------------|-----------|------------------|---------------------|-----------|------------------|----------------|
| Rocker Handle Color | Indicating Color | Marking Color | Indicates: | Unmarked | Vertical Mounting | | | Horizontal Mounting | | | Marking Detail |
| | | | | | On-Off Fig.1 | I-O Fig.2 | On-Off I-O Fig.3 | On-Off Fig.4 | I-O Fig.5 | On-Off I-O Fig.6 | |
| Black | N/A | White | N/A | -00 | -01 | -02 | -03 | -04 | -05 | -06 | A |
| Red | N/A | White | N/A | -20 | -21 | -22 | -23 | -24 | -25 | -26 | |
| Grey | N/A | Black | N/A | -40 | -41 | -42 | -43 | -44 | -45 | -46 | |
| Orange | N/A | Black | N/A | -50 | -51 | -52 | -53 | -54 | -55 | -56 | |
| White | N/A | Black | N/A | -90 | -91 | -92 | -93 | -94 | -95 | -96 | |
| LEGZX Rocker Handle (Dual Rocker Color) | | | | | | | | | | | |
| Black | White | White | On | -A0 | -A1 | -A2 | -A3 | -A4 | -A5 | -A6 | A |
| Black | Red | White | On | -B0 | -B1 | -B2 | -B3 | -B4 | -B5 | -B6 | |
| Black | Green | White | On | -C0 | -C1 | -C2 | -C3 | -C4 | -C5 | -C6 | |
| Black | White | White | Off | -F0 | -F1 | -F2 | -F3 | -F4 | -F5 | -F6 | |
| Black | Red | White | Off | -G0 | -G1 | -G2 | -G3 | -G4 | -G5 | -G6 | |
| Black | Green | White | Off | -H0 | -H1 | -H2 | -H3 | -H4 | -H5 | -H6 | |
| Black | White | White | On | -J0 | -J1 | -J2 | -J3 | -J4 | -J5 | -J6 | B |
| Black | Red | White | On | -K0 | -K1 | -K2 | -K3 | -K4 | -K5 | -K6 | |
| Black | Green | White | On | -L0 | -L1 | -L2 | -L3 | -L4 | -L5 | -L6 | |
| LEGBX Rocker Handle (Dual Rocker Color) | | | | | | | | | | | |
| Black | White | White | Off | -M0 | N/A | -M2 | -M3 | N/A | N/A | -M6 | C |
| Black | Red | Red | Off | -N0 | N/A | -N2 | -N3 | N/A | N/A | -N6 | |
| Black | Green | Green | Off | -P0 | N/A | -P2 | -P3 | N/A | N/A | -P6 | |
| Black | Yellow | Yellow | Off | -R0 | N/A | -R2 | -R3 | N/A | N/A | -R6 | |

Notes: A. Bezels of LEGBX are black.
 B. Consult factory for other marking options.

AIRPAX®

LEGA Series

Low-Depth, Hydraulic-Magnetic Circuit Breakers



Introduction • 123

Configurations • 124

Delay Curves • 127

Operating Characteristics • 128

Decision Tables • 129





AIRPAX® | LEGA Series

Low-Depth, Hydraulic-Magnetic Circuit Breakers

INTRODUCTION

Developed to meet the evolving demand for low-profile datacenter rack power distribution units, the Airpax™ LEGA series circuit breaker provides a cost effective solution with uncompromising performance and reliability in a low-depth package. The UL-489 Listed product includes TÜV certification to EN60947-2 for global acceptance in UL-60950 and EN60950 ITE applications, a variety of limited access actuator styles and secure screw terminals oriented for ease of assembly and efficient power conductor routing.

FEATURES

- Retains proven high performance specifications & reliability of the Airpax™ LEG series
- Low-depth design to minimize PDU intrusion into equipment rack space
- Rear access screw terminals provide secure vibration resistant connection for high reliability applications
- Terminal orientation allows simple power conductor routing and ease of assembly
- Global agency certifications for UL60950 and EN60950 ITE requirements
- Short toggle and flat rocker actuators available for protection against accidental “turn-off”
- Barriers fold-away to allow easier screw access

SPECIFICATIONS

| Agency Certification | Rated Amperage | Maximum Voltage | Short Circuit Amperage | Phase |
|-------------------------|------------------------|---------------------|------------------------|-------|
| UL-489 | 1.00A - 30.0A | 120vac, 50/60Hz | 5,000A | 1 |
| UL-489 | 1.00A - 30.0A | 120/240vac, 50/60Hz | 5,000A | 1 |
| UL-489 | 1.00A - 50.0A | 80vdc | 5,000A | — |
| UL-489 | 1.00A - 20.0A (3 pole) | 208Y/120 | 5,000A | 3 |
| TÜV (EN60947-2) lcs | 1.00A - 30.0A | 250vac, 50/60Hz | 3,000A | 1 |
| TÜV TUV (EN60947-2) lcs | 1.00A - 50.0A | 80vdc | 3,000A | — |
| TÜV (EN60947-2) lcs | 1.00A - 30.0A | 240/415vac, 50/60Hz | 3,000A | 1 & 3 |

CONFIGURATIONS - TOGGLE HANDLE

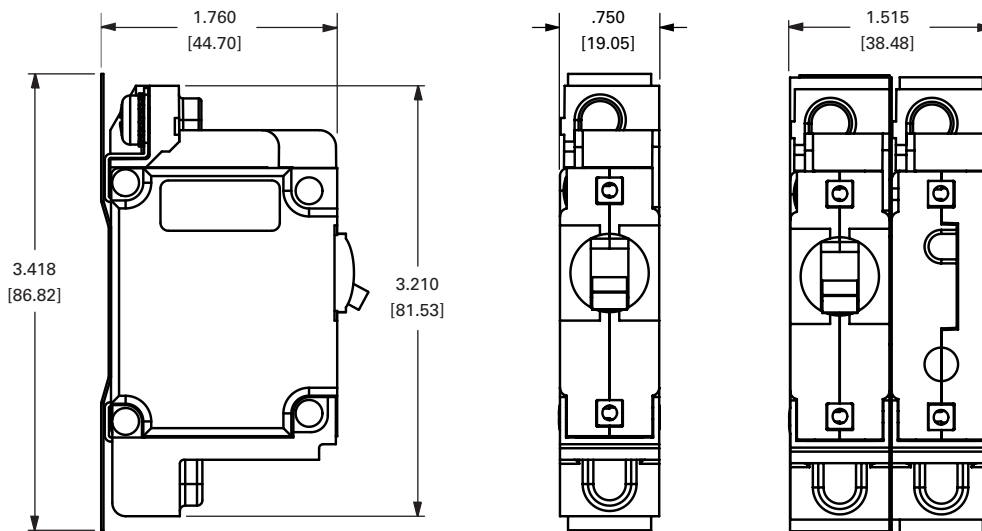

Single Pole, Toggle Handle

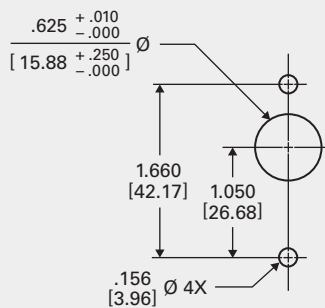

Two Pole, Single Toggle Handle

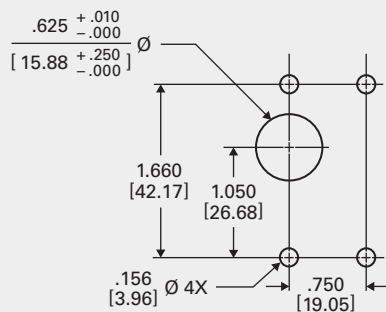

Two Pole, Two Toggle Handles

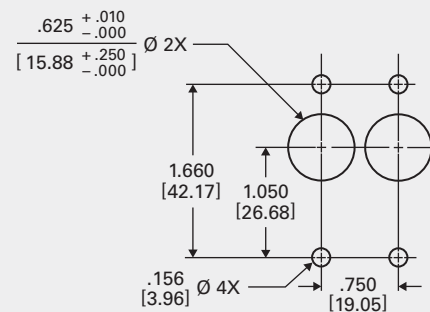

Panel Mounting Detail: Tolerance for Mtg. $\pm .005$ [.13] unless noted.

CONFIGURATIONS - BX & ZX ROCKER HANDLES

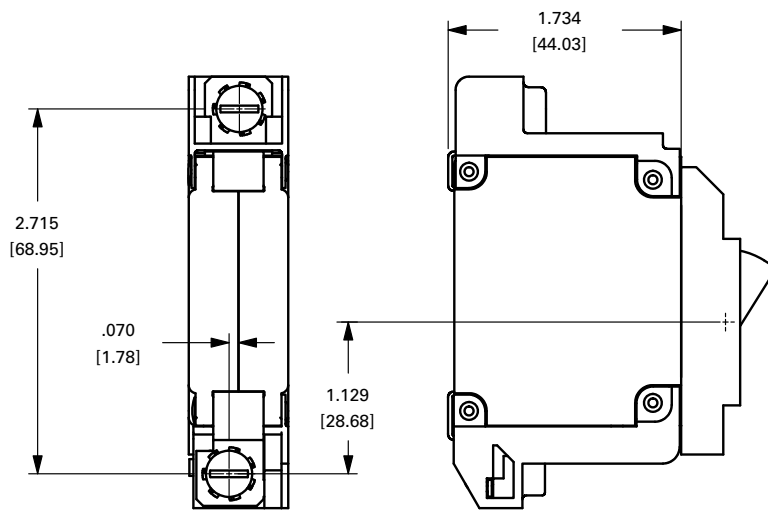
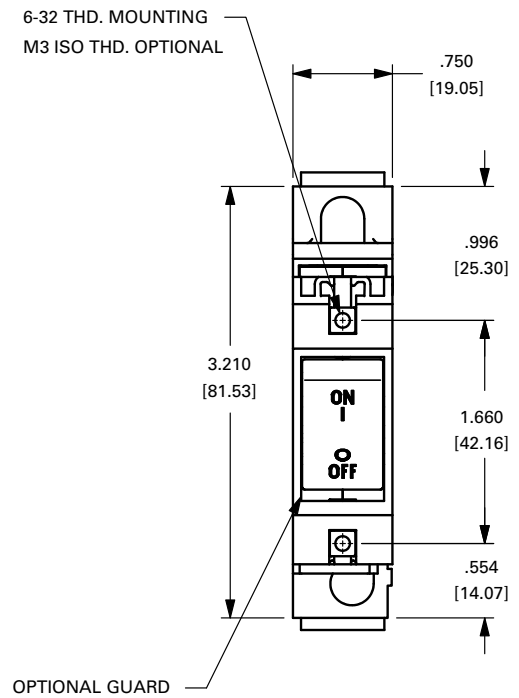
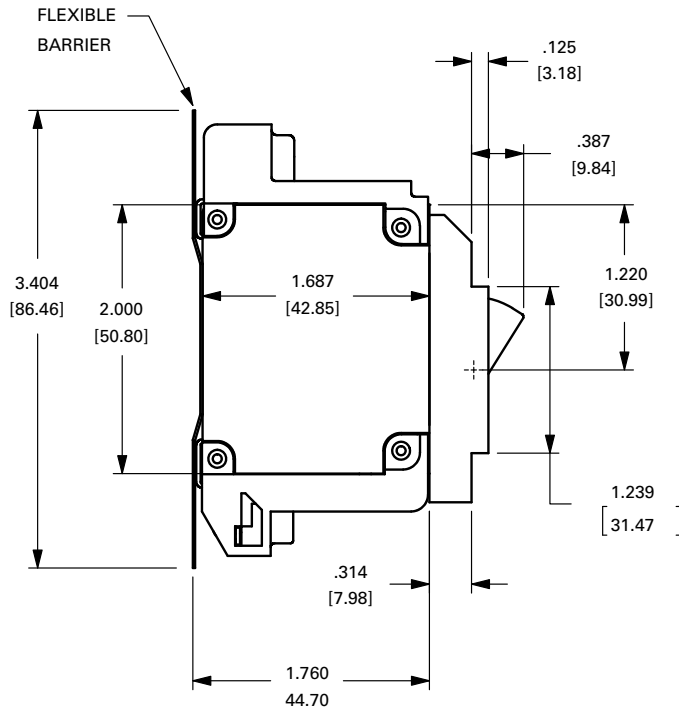

Note: Barrier removed for clarity

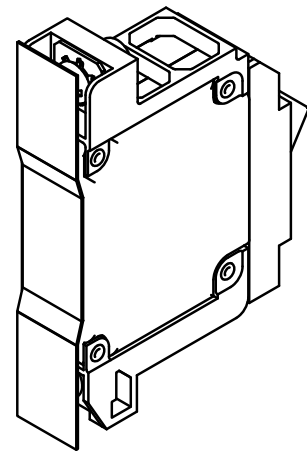

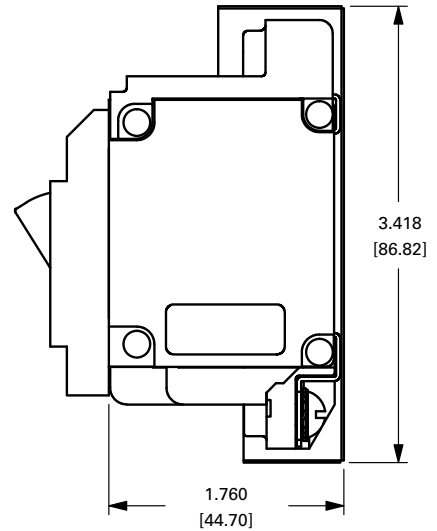
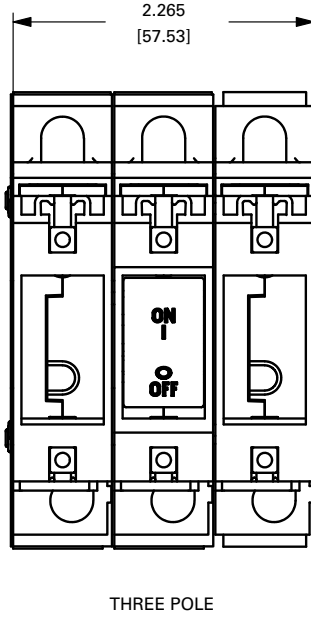
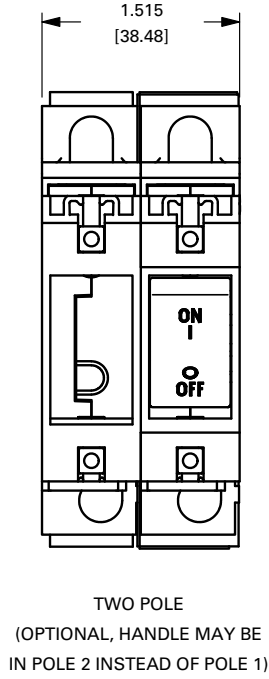

Single Pole, Rocker Handle

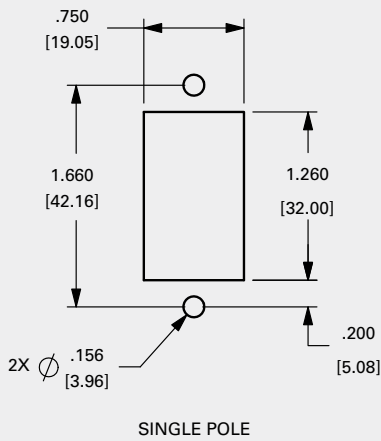

Two Pole, Rocker Handle

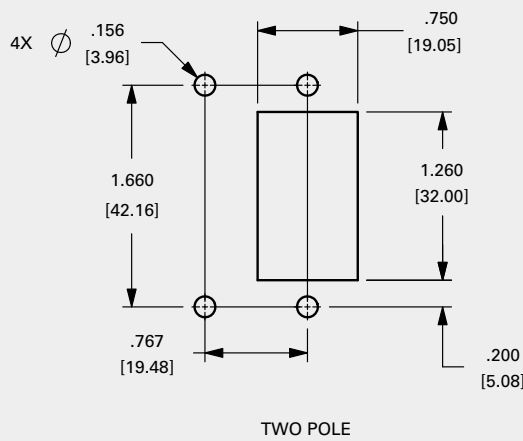

Three Pole, Rocker Handle

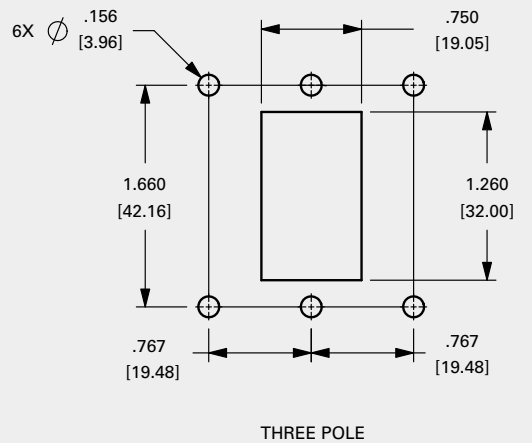

Panel Mounting Detail: Tolerance for Mtg. \pm .005 [.13] unless noted.

DELAY CURVES

DC Short Delay

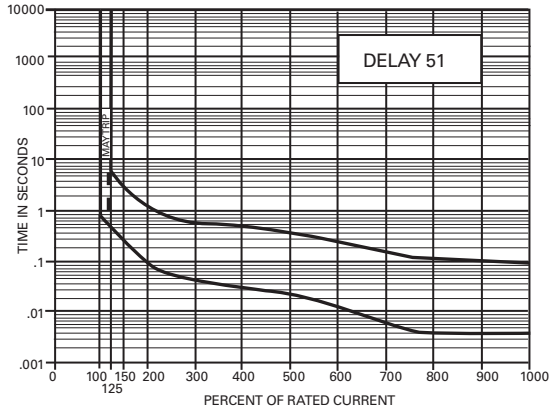

50/60Hz Short Delay

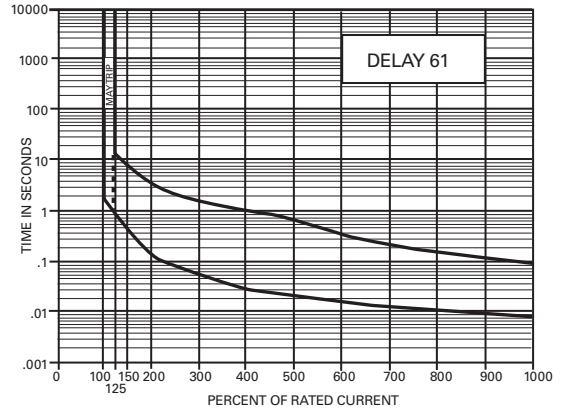

DC Medium Delay

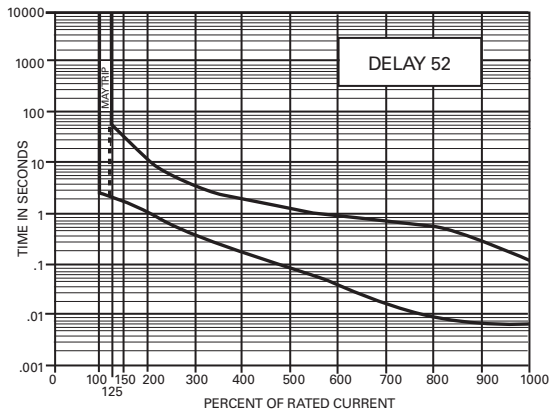

50/60Hz Medium Delay

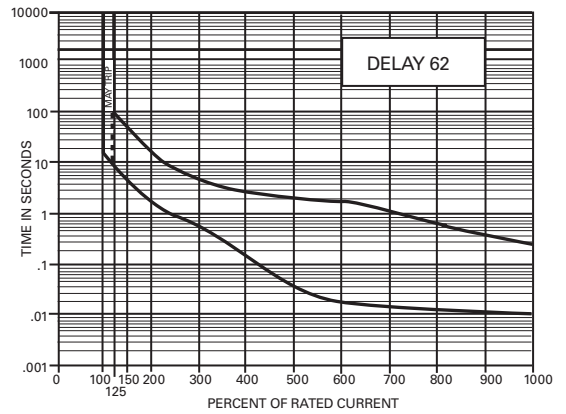

DC Long Delay (Motor Start)

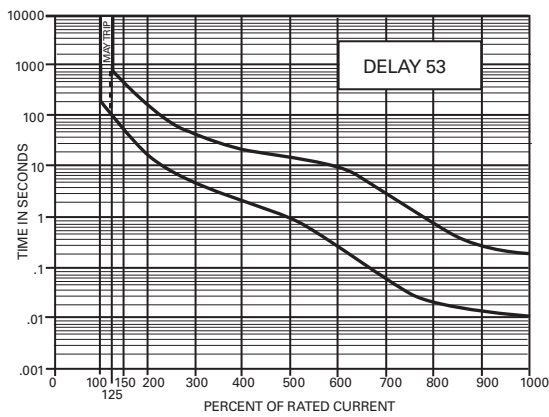

50/60Hz Long Delay (Motor Start)

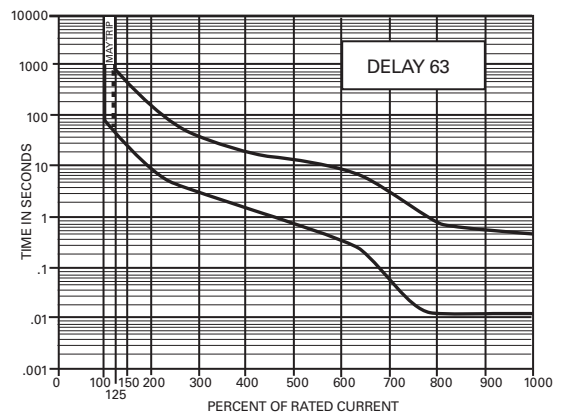

OPERATING CHARACTERISTICS - SERIES TRIP

The most popular configuration for hydraulic-magnetic circuit breakers is the series trip, where the sensing coil and contacts are in series with the load being protected. The handle position conveniently indicates circuit status. In addition to providing conventional over-current protection, it's simultaneously used as an ON-OFF switch.



PERCENTAGE OF RATED CURRENT VS TRIP TIME IN SECONDS AT +25°C (VERTICAL MOUNT)

| Delay | 100% | 125% | 150% | 200% | 400% | 600% | 800% | 1000% |
|-------|---------|-------------|-------------|-------------|--------------|-------------|-------------|-------------|
| 51 | No Trip | .500 to 6.5 | .300 to 3.0 | .100 to 1.2 | .031 to .500 | .011 to .25 | .004 to .1 | .004 to .08 |
| 52 | No Trip | 2 to 60 | 1.8 to 30 | 1 to 10 | .15 to 2.0 | .04 to 1 | .008 to .5 | .006 to .1 |
| 53 | No Trip | 80 to 700 | 40 to 400 | 15 to 150 | 2 to 20 | .23 to 9 | .018 to .55 | .012 to .2 |
| 61 | No Trip | .700 to 12 | .35 to 7.0 | .130 to 3.0 | .030 to 1 | .015 to .3 | .01 to .15 | .008 to .1 |
| 62 | No Trip | 10 to 120 | 6 to 60 | 2 to 20 | .2 to 3.0 | .02 to 2 | .015 to .8 | .01 to .25 |
| 63 | No Trip | 50 to 700 | 30 to 400 | 10 to 150 | 1.5 to 20 | .4 to 10 | .013 to .85 | .013 to .5 |

INRUSH PULSE TOLERANCE

| Delay | Pulse Tolerance |
|---------------|---------------------------------|
| 61, 62, 63 | 10 times rated current (approx) |
| 61F, 62F, 63F | 12 times rated current (approx) |

The table above provides a comparison of inrush pulse tolerance with and without the inertial delay feature for each of the 50/60Hz delays. Pulse tolerance is defined as a single pulse of half sine wave peak current amplitude of 8 milliseconds duration that will not trip the circuit breaker. Consult Sensata Technologies for further assistance.

TYPICAL RESISTANCE / IMPEDANCE

| Current Ratings (Amps) | Impedance | |
|---------------------------|------------|--------------------|
| | DC (ohms) | AC, 50/60Hz (ohms) |
| | 51, 52, 53 | 61, 62, 63 |
| 0.200 | 36.6 | 34.2 |
| 1.00 | 1.38 | 1.47 |
| 2.00 | 0.31 | 0.25 |
| 5.00 | 0.053 | 0.051 |
| 10.0 | 0.016 | 0.013 |
| 20.0 | 0.006 | 0.005 |
| 30.0 | 0.0027 | 0.0026 |
| 50.0 | 0.0019 | — |

DCR and Impedance based on 100% rated current applied and stabilized for a minimum of one hour. Tolerance .05-2.5 amperes ± 20%; 2.6-20 amperes ± 25%; 21-50 amperes ± 50%. Consult factory for special values and for coil impedance of delays not shown.

DECISION TABLES

| 1. Type & Handle | | | |
|------------------|-------------------------------|--|---|
| Step 1a | | Step 1b | |
| LEG | One handle per unit | A | Standard toggle & mounting, Low depth construction |
| LEGH | One handle per pole | ZXA* | ZX rocker with integral mounting, Low depth construction |
| LMG | One handle per unit, mid-trip | BXA* | BX flat rocker with integral mounting, Low depth construction |
| LMGH | One handle per pole, mid-trip | <i>** All types are UL-489 Listed</i> <i>* Rockers can not have option "H", a handle per pole (for example LEGHZXA or LMGHBXA is incorrect)</i> | |

| 2. Poles & Terminals | |
|----------------------|------------------------------|
| 6 | Single Pole, Screw Terminals |
| 66 | Two Poles, Screw Terminals |
| 666 | Three Poles, Screw Terminals |

| 3. Internal Configuration | |
|---------------------------|--------|
| 1 | Series |

| 4. Frequency & Delay | | | |
|----------------------|----------------------------------|---|----------------|
| Step 4a | | Step 4b | |
| SW | Switch only | | Standard |
| 51 | DC short delay | F | Inertial wheel |
| 52 | DC medium delay | <i>All delays can add an optional inertial wheel by adding an "F" to the end of the code.</i> <i>Example: 61 becomes 61F</i> | |
| 53 | DC long delay | | |
| 61 | 50/60Hz short delay | | |
| 62 | 50/60Hz medium delay | | |
| 63 | 50/60Hz long delay (motor start) | | |

| 5. Rated Current | | |
|------------------|-----------|--|
| 1.0 | 1 amp | <i>*** Ratings over 30 amps only available with DC delay characteristics</i> |
| 5.0 | 5 amp | |
| 7.5 | 7.5 amp | |
| 10.0 | 10 amp | <i>Other ratings available upon request</i> |
| 12.5 | 12.5 amp | |
| 15.0 | 15 amp | |
| 16.0 | 16 amp | |
| 20.0 | 20 amp | |
| 25.0 | 25 amp | |
| 30.0 | 30 amp | |
| 40.0 | 40 amp*** | |
| 50.0 | 50 amp*** | |

| 6. Additional Options | |
|-----------------------|---|
| | Standard hardware, no options required |
| A | Metric thread mounting inserts and terminal hardware |
| G | Hand guard (available for ZX & BX versions only) |
| M | Handle in opposite pole (2-pole only) |
| Q | APG/UPG style "fat" toggle actuator |
| X | Handle guard with no actuation feature (BX only, no mid-trip) |

| 8. Approvals | |
|--------------|--|
| T | TÜV approved Certified to EN60947-2 Includes the CE mark |

LEGBXA 66 – 1 – 62 – 20.0 – AG – M6 – T

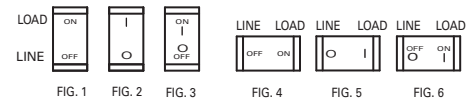

MARKING DETAIL "A"

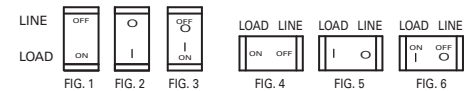

MARKING DETAIL "B"

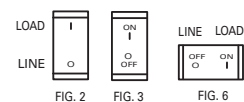

MARKING DETAIL "C"

7. Handle Colors, Indicators & Markings

Toggle Handle

| Unmarked | Marked ON - OFF I - O | Handle Color | Unmarked | Marked ON - OFF I - O | Handle Color | Unmarked | Marked ON - OFF I - O | Handle Color | Unmarked | Marked ON - OFF I - O | Handle Color |
|----------|-----------------------------|-----------------|----------|-----------------------------|-----------------|----------|-----------------------------|-----------------|----------|-----------------------------|-----------------|
| - 00 | - 01 | Black | - 10 | - 11 | Yellow | - 20 | - 21 | Red | - 30 | - 31 | Blue |
| - 40 | - 41 | Green | - 60 | - 61 | Orange | - 90 | - 91 | White | | | |

ZX Rocker Handle (Single-Color Rocker)

Marking Detail A

| Unmarked | Vertical Mount ON - OFF <i>(fig 1)</i> | Vertical Mount I - O <i>(fig 2)</i> | Vertical Mount ON - OFF I - O <i>(fig 3)</i> | Horizontal Mount ON - OFF <i>(fig 4)</i> | Horizontal Mount I - O <i>(fig 5)</i> | Horizontal Mount ON - OFF I - O <i>(fig 6)</i> | Handle Color | Indicating Color | Marking Color | Indicates |
|----------|--|---|---|--|---|---|-----------------|---------------------|------------------|-----------|
| - 00 | - 01 | - 02 | - 03 | - 04 | - 05 | - 06 | Black | — | White | — |
| - 20 | - 21 | - 22 | - 23 | - 24 | - 25 | - 26 | Red | — | White | — |
| - 40 | - 41 | - 42 | - 43 | - 44 | - 45 | - 46 | Gray | — | Black | — |
| - 50 | - 51 | - 52 | - 53 | - 54 | - 55 | - 56 | Orange | — | Black | — |
| - 90 | - 91 | - 92 | - 93 | - 94 | - 95 | - 96 | White | — | Black | — |

ZX Rocker Handle (Two-Color Rocker)

Marking Detail A & B

| Unmarked | Vertical Mount ON - OFF <i>(fig 1)</i> | Vertical Mount I - O <i>(fig 2)</i> | Vertical Mount ON - OFF I - O <i>(fig 3)</i> | Horizontal Mount ON - OFF <i>(fig 4)</i> | Horizontal Mount I - O <i>(fig 5)</i> | Horizontal Mount ON - OFF I - O <i>(fig 6)</i> | Handle Color | Indicating Color | Marking Color | Indicates |
|----------|--|---|---|--|---|---|-----------------|---------------------|------------------|-----------|
| - A0 | - A1 | - A2 | - A3 | - A4 | - A5 | - A6 | Black | White | White | ON |
| - B0 | - B1 | - B2 | - B3 | - B4 | - B5 | - B6 | Black | Red | White | ON |
| - C0 | - C1 | - C2 | - C3 | - C4 | - C5 | - C6 | Black | Green | White | ON |
| - F0 | - F1 | - F2 | - F3 | - F4 | - F5 | - F6 | Black | White | White | OFF |
| - G0 | - G1 | - G2 | - G3 | - G4 | - G5 | - G6 | Black | Red | White | OFF |
| - H0 | - H1 | - H2 | - H3 | - H4 | - H5 | - H6 | Black | Green | White | OFF |
| - J0 | - J1 | - J2 | - J3 | - J4 | - J5 | - J6 | Black | White | White | ON |
| - K0 | - K1 | - K2 | - K3 | - K4 | - K5 | - K6 | Black | Red | White | ON |
| - L0 | - L1 | - L2 | - L3 | - L4 | - L5 | - L6 | Black | Green | White | ON |

BX Rocker Handle (Two-Color Rocker)

Marking Detail C

| Unmarked | Vertical Mount ON - OFF <i>(fig 1)</i> | Vertical Mount I - O <i>(fig 2)</i> | Vertical Mount ON - OFF I - O <i>(fig 3)</i> | Horizontal Mount ON - OFF <i>(fig 4)</i> | Horizontal Mount I - O <i>(fig 5)</i> | Horizontal Mount ON - OFF I - O <i>(fig 6)</i> | Handle Color | Indicating Color | Marking Color | Indicates |
|----------|--|---|---|--|---|---|-----------------|---------------------|------------------|-----------|
| - M0 | — | - M2 | - M3 | — | — | - M6 | Black | White | White | OFF |
| - N0 | — | - N2 | - N3 | — | — | - N6 | Black | Red | Red | OFF |
| - P0 | — | - P2 | - P3 | — | — | - P6 | Black | Green | Green | OFF |
| - R0 | — | - R2 | - R3 | — | — | - R6 | Black | Yellow | Yellow | OFF |

Bezel of BX is black. Consult factory for other marking options.
Black, red, blue and green handles have white marking. White, yellow and orange handles have black marking.

AIRPAX®

LEJ & LEJA Series Hydraulic-Magnetic Circuit Breakers



- Introduction* • 133
- Configurations* • 134
- Delay Curves* • 142
- Decision Tables* • 143





AIRPAX® | LEJ & LEJA Series

Hydraulic-Magnetic Circuit Breakers

INTRODUCTION

The LEJ/LEJA series circuit breaker meets the evolving demand for the high performance protection of critical data center and telecommunications applications requiring 240VAC per pole, UL 489 listing in the smallest case size currently available in the marketplace. The LEJ/LEJA platform is based on the highly successful and field proven LEG/LEGA designs while incorporating state-of-the-art arc quenching technologies and offering voltage ratings that are well suited for global applications that require 208VAC through 240VAC ratings for increased power efficiency.

Typical applications include power distribution units (PDUs) used in data center enclosures, telecom AC power supplies and a variety of Industrial applications benefiting from the higher power density. Like the LEG/LEGA product family, the LEJ/LEJA series offers a variety of features including different terminations and actuators to meet most any requirements.

FEATURES

- Up to two poles, 2 amps to 20 amps rated current at 240VAC per pole
- UL 489 listed and TÜV approvals available
- 5000AIC short circuit amperage rating
- Low Depth "A" option provides a 31% lower depth compared to standard LEJ product
- Maintains the high performance characteristics, reliability, panel cut out and mounting dimensions of LEG/LEGA products

SPECIFICATIONS

| Agency Certification | Rated Amperage | Maximum Voltage | Short Circuit Amperage |
|----------------------|----------------|-------------------|------------------------|
| UL 489 | 2 to 20 amps | 240 VAC, 50/60 Hz | 5000 |
| TÜV (EN60947-2) | 2 to 20 amps | 240 VAC, 50/60 Hz | 5000 |

CONFIGURATIONS: LEJ TOGGLE HANDLE

SINGLE POLE

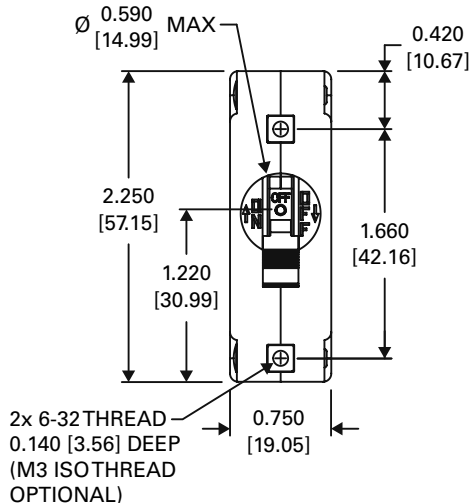
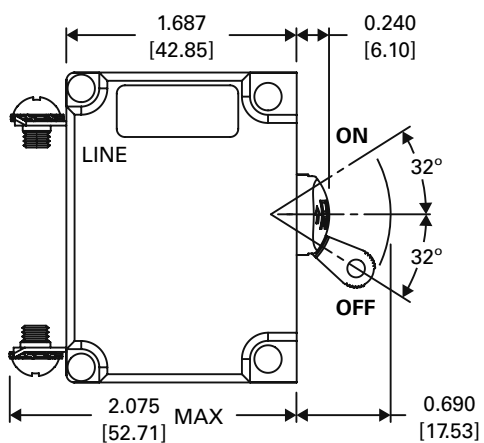

TWO POLE, 1 HANDLE

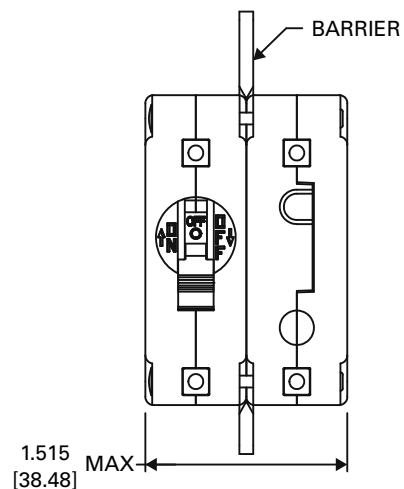

OPTIONAL, HANDLE MAY BE IN POLE 1 INSTEAD OF POLE 2

TWO POLE, 2 HANDLE

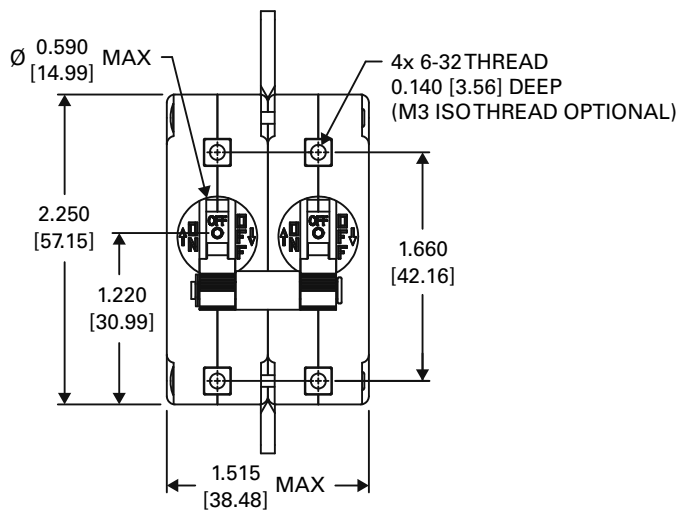
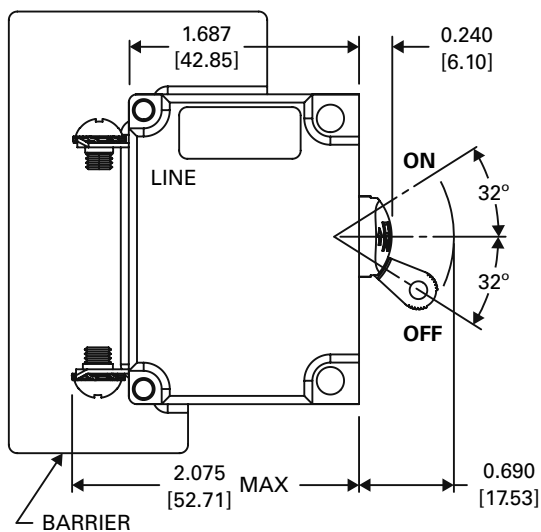

PANEL MOUNT CUTOUT - 1 POLE

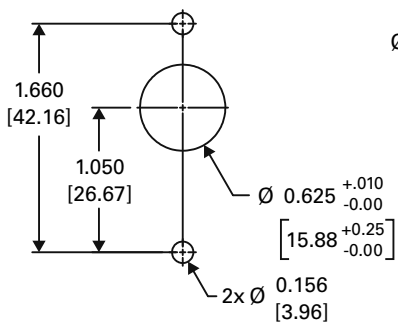

PANEL MOUNT CUTOUT - 2 POLE, 1 HANDLE

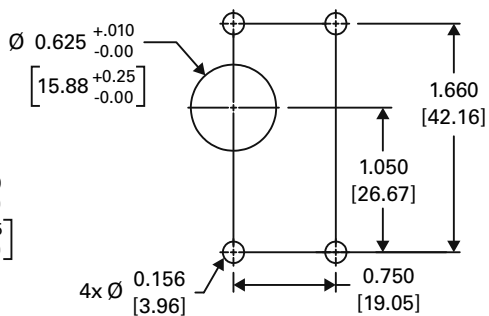

PANEL MOUNT CUTOUT - 2 POLE, 2 HANDLE

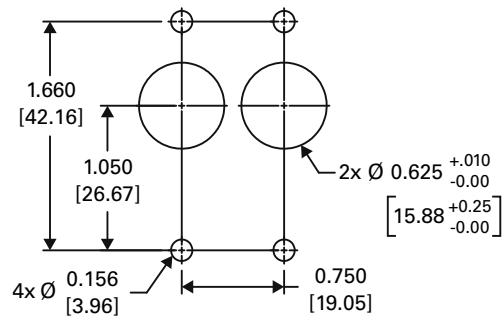

NOTES:

1. All mounting inserts shall be utilized when panel mounting circuit breakers. Panel mounting screws shall have recommended torque applied: 6/32 mounting inserts 6 - 8 inch pounds. M3 mounting inserts 4 - 5 inch pounds.
2. Panel mounting screws shall not extend beyond back of mounting panel more than specified mounting insert depth.
3. Mounting detail tolerance: ± 0.005 [0.13] unless noted.

CONFIGURATIONS: LEJZX ROCKER HANDLE

SINGLE POLE

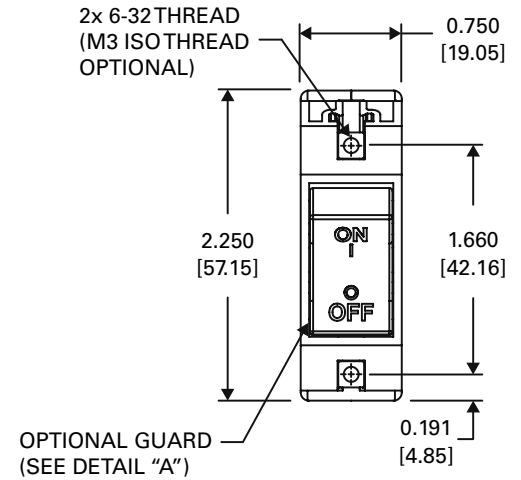
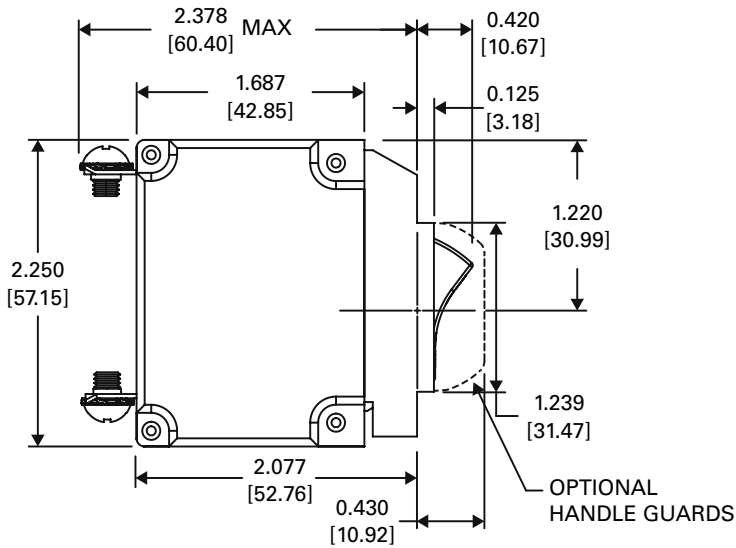

TWO POLE

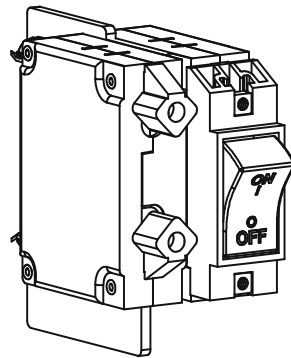
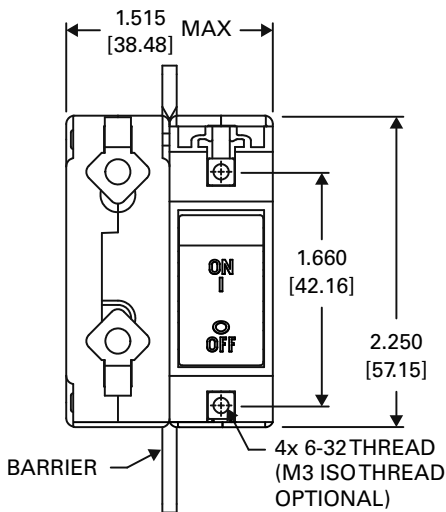

OPTIONAL, HANDLE MAY BE IN POLE 2 INSTEAD OF POLE 1

PANEL MOUNT CUTOUT - 1 or 2 POLE

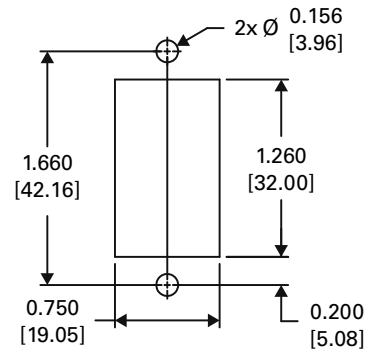

NOTES:

1. All mounting inserts shall be utilized when panel mounting circuit breakers. Panel mounting screws shall have recommended torque applied: 6/32 mounting inserts 6 - 8 inch pounds. M3 mounting inserts 4 - 5 inch pounds.
2. Panel mounting screws shall not extend beyond back of mounting panel more than specified mounting insert depth.
3. Mounting detail tolerance: ± 0.005 [0.13] unless noted.
4. Two pole ZX has standoffs (as shown). It uses 2 panel screws. A higher shock capability (4 panel screws) is available (consult factory).

CONFIGURATIONS: LEJBX ROCKER HANDLE

SINGLE POLE

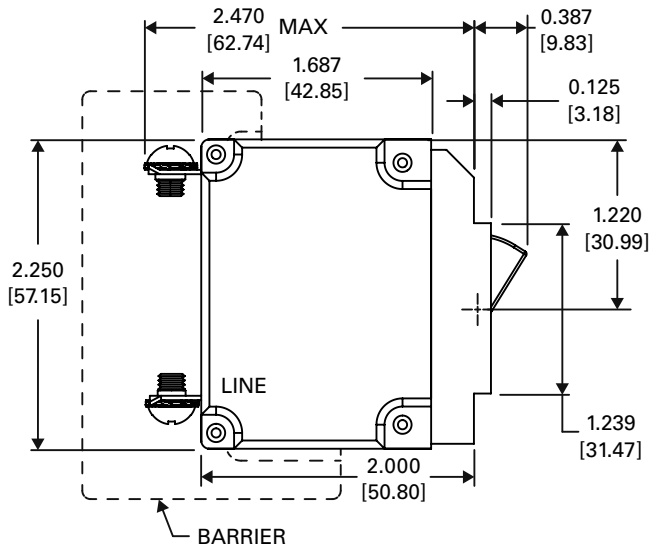

TWO POLE

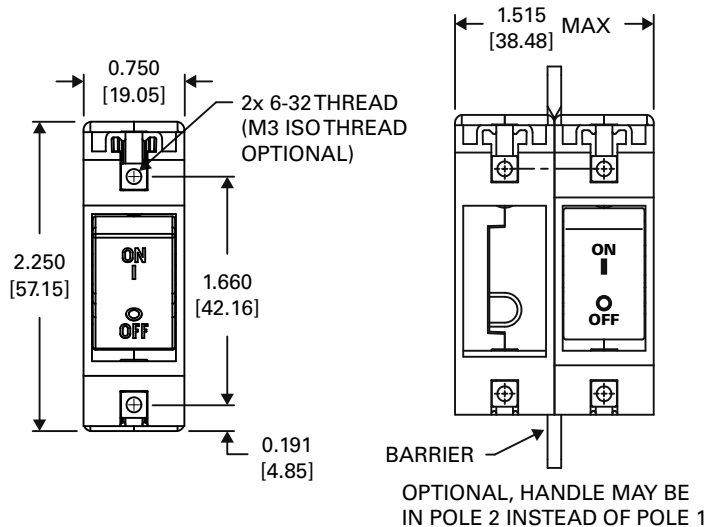

BX HANDLE WITHOUT GUARD

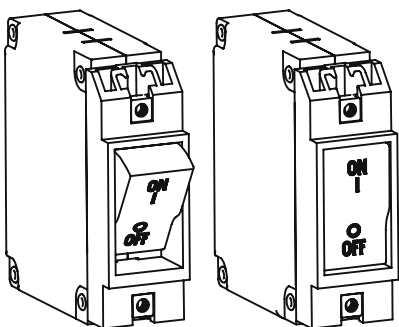

GUARD (LIMITED ACCESS ACTUATE-OFF)

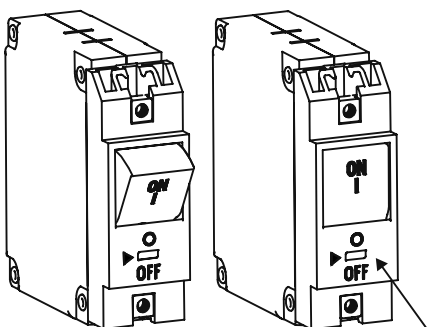

ACCESS TO ACTUATE OFF IS LIMITED TO A DEVICE SMALLER THAN 0.069 [1.75] x 0.155 [3.94]

PANEL MOUNT CUTOUT (1 POLE)

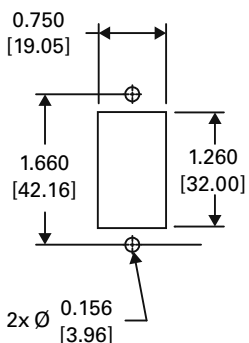

PANEL MOUNT CUTOUT (2 POLE)

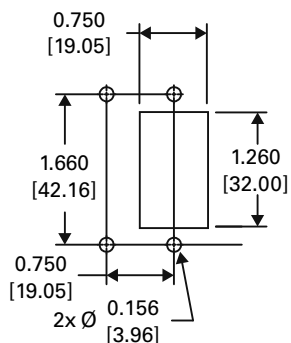

PANEL PLUG (CONSULT FACTORY FOR AVAILABILITY)

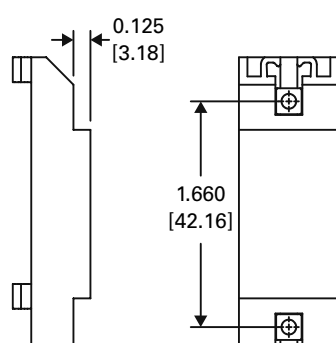

- P/N: 121-710-2450
6-32 THD. (BLACK)
- P/N: 121-710-2451
M3 THD. (BLACK)
- P/N: 121-450-3000
6-32 THD. (BLACK)
- P/N: 121-450-3001
M3 THD. (BLACK)

CONFIGURATIONS: LEJA, TOGGLE HANDLE

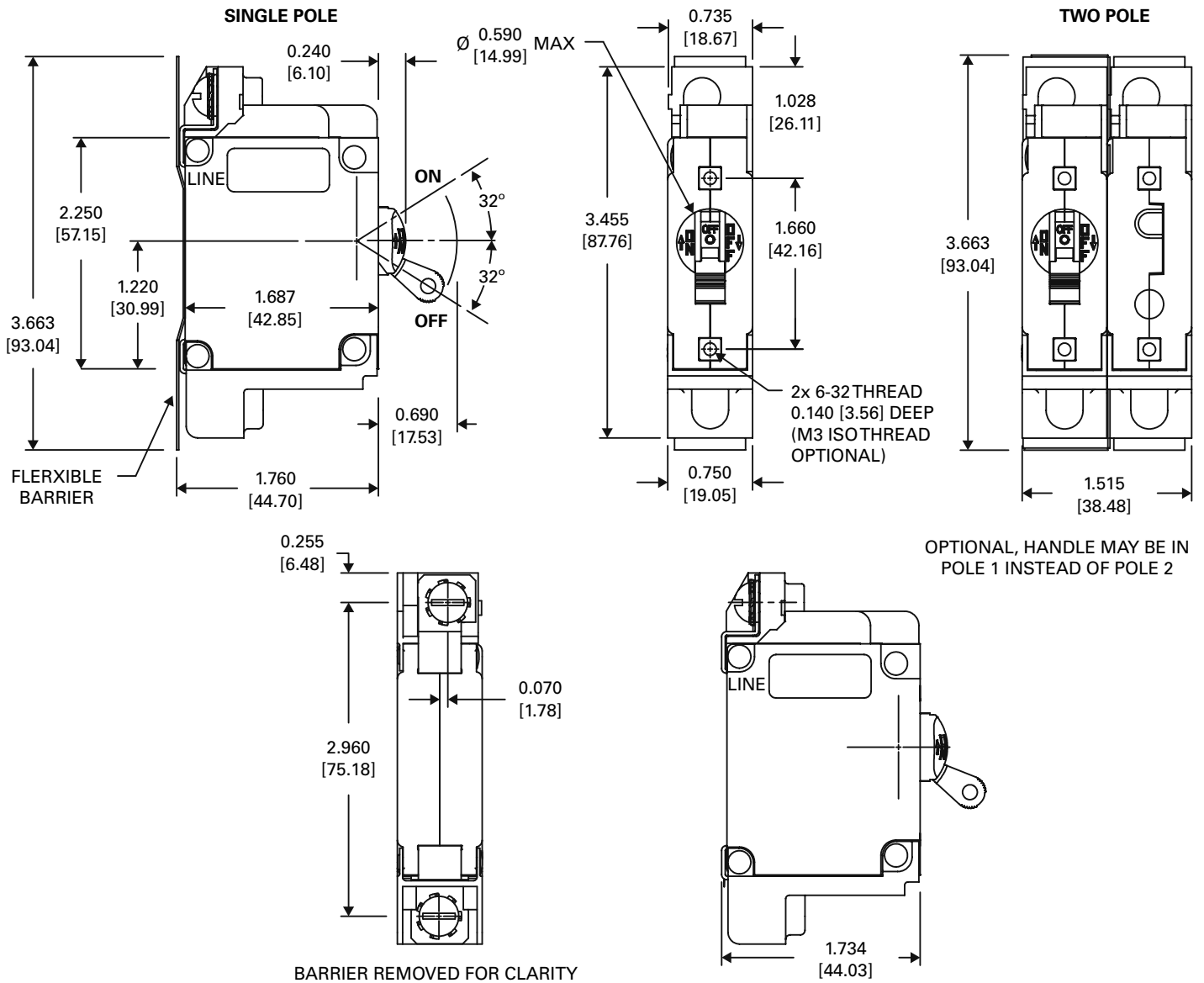

PANEL MOUNT CUTOUT - 1 POLE

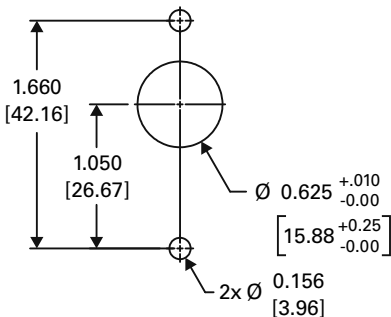

PANEL MOUNT CUTOUT - 2 POLE, 1 HANDLE

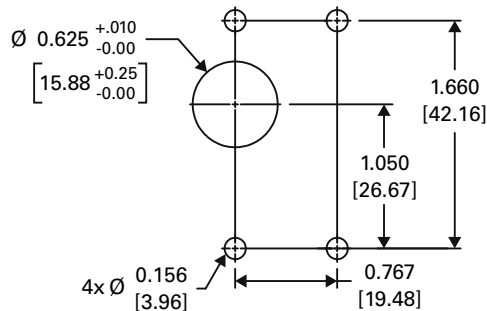

NOTES:

1. All mounting inserts shall be utilized when panel mounting circuit breakers. Panel mounting screws shall have recommended torque applied: 6/32 mounting inserts 6 - 8 inch pounds. M3 mounting inserts 4 - 5 inch pounds.
2. Panel mounting screws shall not extend beyond back of mounting panel more than specified mounting insert depth.
3. Mounting detail tolerance: ± 0.005 [0.13] unless noted.

CONFIGURATIONS: LEJBXA ROCKER HANDLE

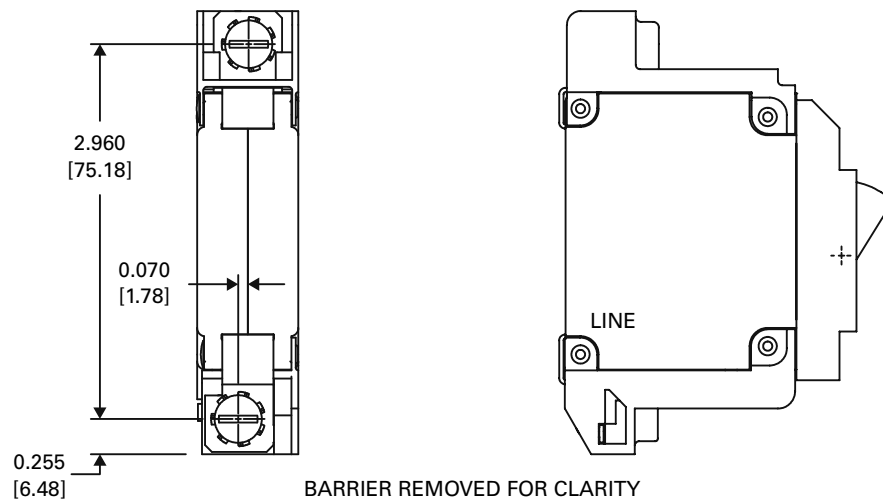
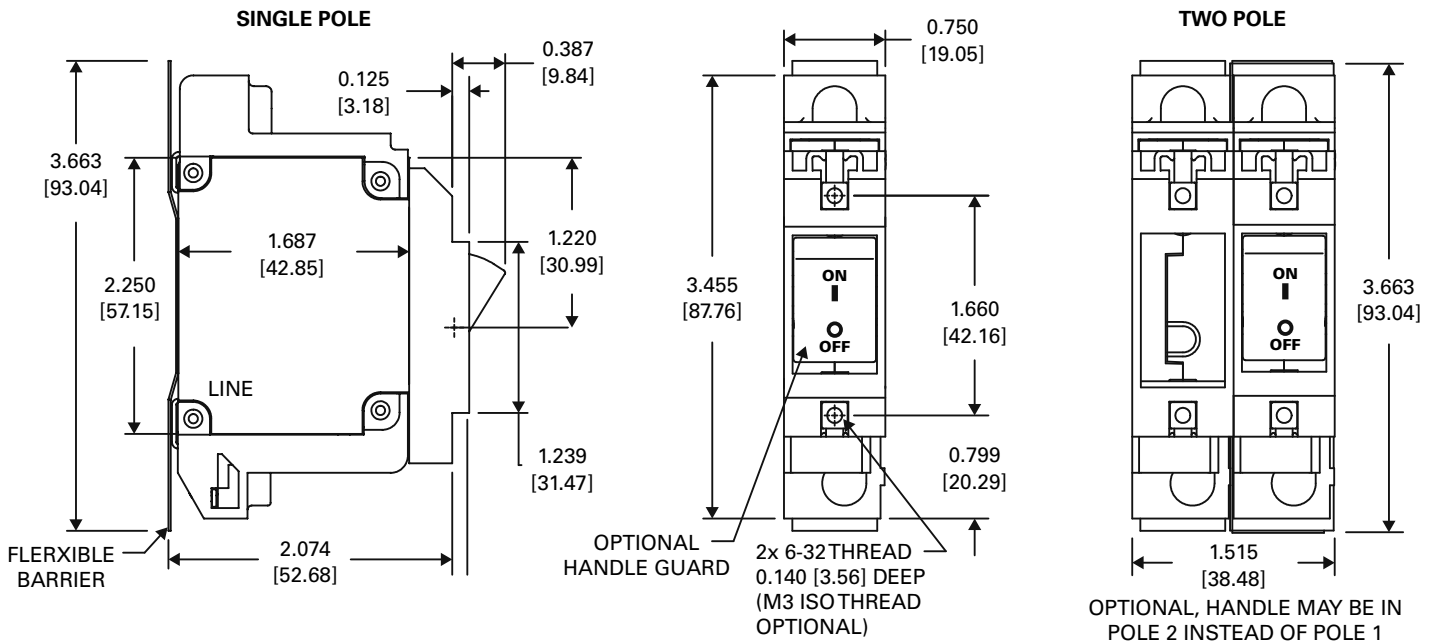

PANEL MOUNT CUTOUT - 1 POLE

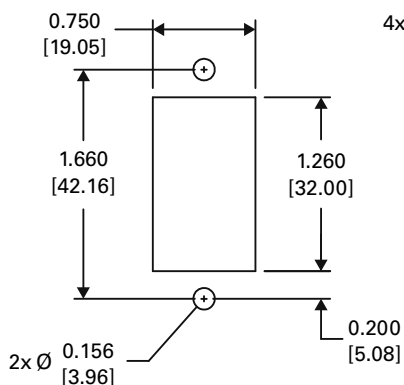

PANEL MOUNT CUTOUT - 2 POLE

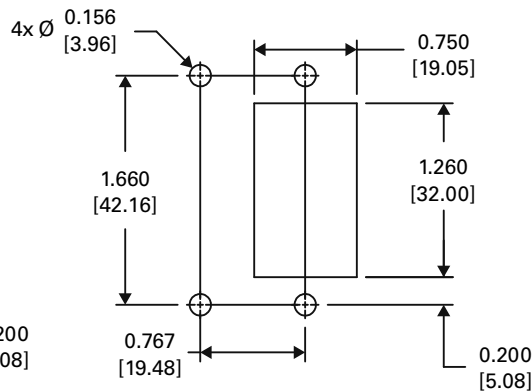

NOTES:

1. All mounting inserts shall be utilized when panel mounting circuit breakers. Panel mounting screws shall have recommended torque applied: 6/32 mounting inserts 6 - 8 inch pounds. M3 mounting inserts 4 - 5 inch pounds.
2. Panel mounting screws shall not extend beyond back of mounting panel more than specified mounting insert depth.
3. Mounting detail tolerance: ± 0.005 [0.13] unless noted.

CONFIGURATIONS: LEJZX, ROCKER HANDLE

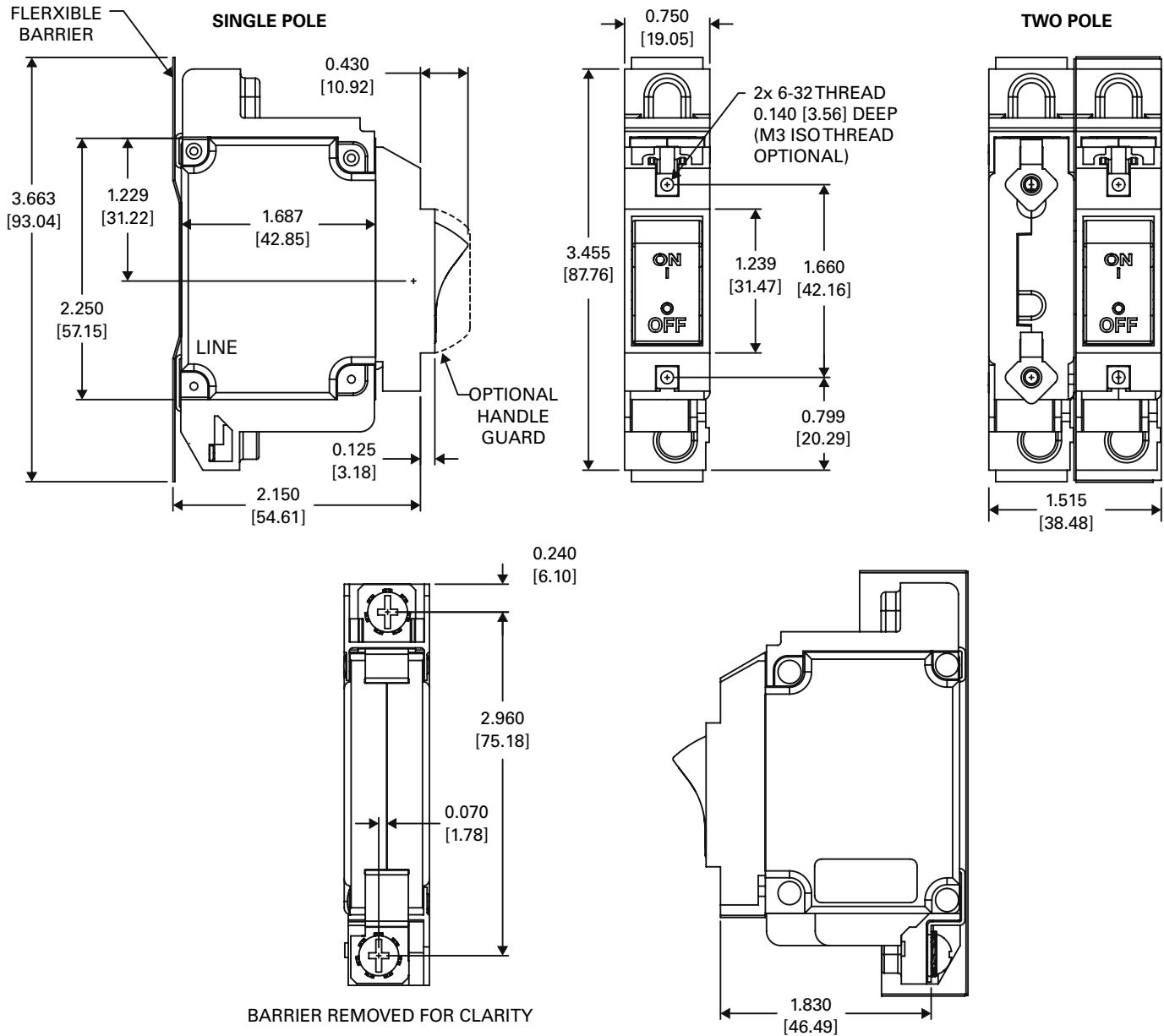

BARRIER REMOVED FOR CLARITY

PANEL MOUNT CUTOUT - 1 POLE

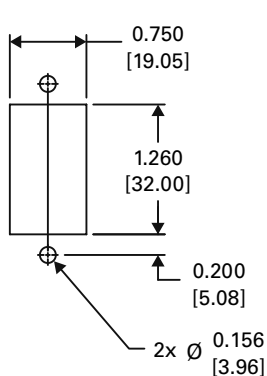

PANEL MOUNT CUTOUT - 2 POLE

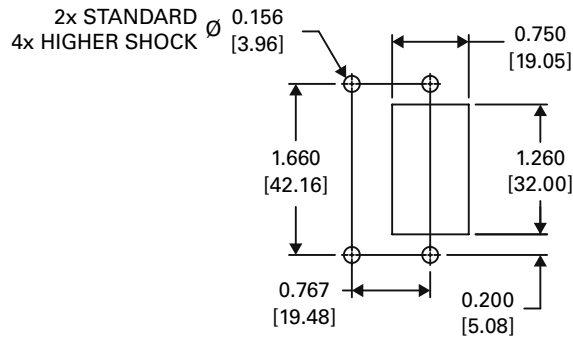

NOTES:

1. All mounting inserts shall be utilized when panel mounting circuit breakers. Panel mounting screws shall have recommended torque applied: 6/32 mounting inserts 6 - 8 inch pounds. M3 mounting inserts 4 - 5 inch pounds. Panel mounting screws shall not extend beyond back of mounting panel more than specified mounting insert depth.
2. Mounting detail tolerance: ± 0.005 [0.13] unless noted.

BARRIER OPTIONS FOR MULTI-POLE UNITS

STANDARD BARRIER - TOGGLE HANDLE

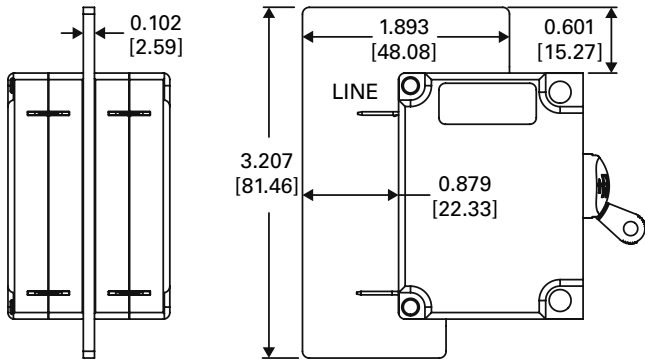

STANDARD BARRIER - ZX & BX HANDLE

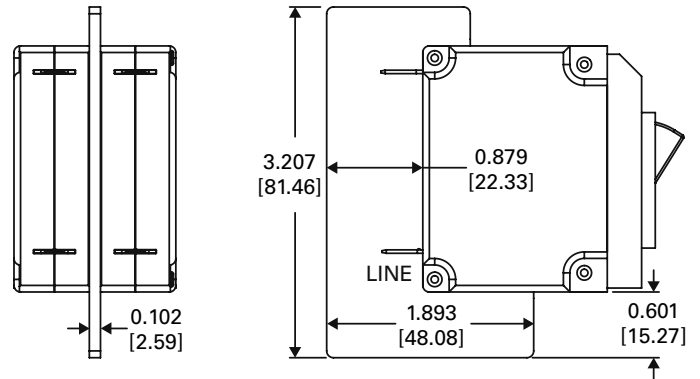

OPTIONAL (-Z) BARRIER - TOGGLE HANDLE

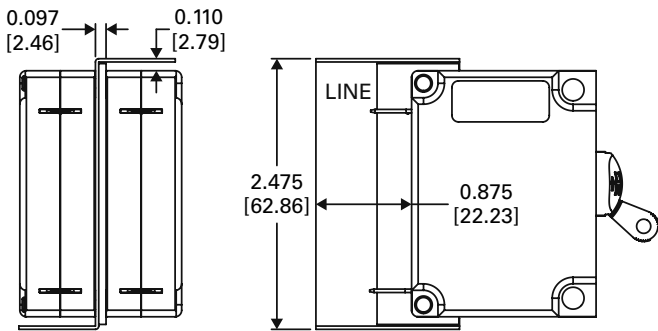

OPTIONAL (-Z) BARRIER - ZX & BX HANDLE

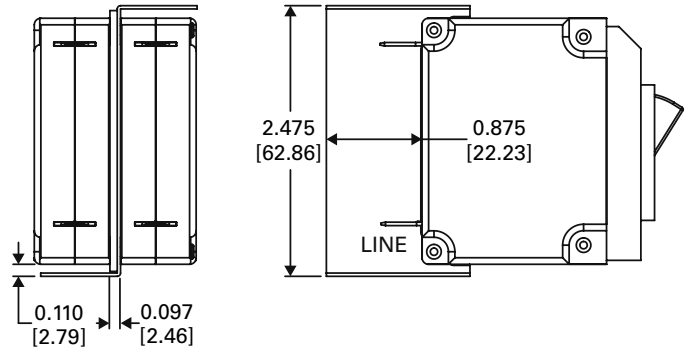

TERMINAL OPTIONS

STANDARD - QUICK CONNECT & SCREW TERMINALS

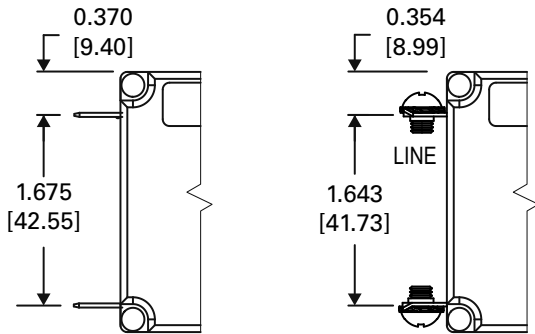

OPTIONAL - FLAT BUS CONNECT SCREW TERMINAL

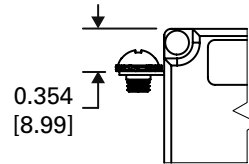

NOTES:

1. Terminals:

Quick Connect = 0.250 [6.35] wide x 0.031 [0.79] thick

Screw = 10-32 or M5 x 0.8

TÜV approval with screw terminals include external tooth lockwashers

OPTIONAL HANDLE LOCK FOR TOGGLE HANDLE

A handle lock option is available to prevent accidental actuation of the handle. The handle lock may be used in the ON or OFF position. This option is available pre-assembled or separately. Consult factory for ordering information.

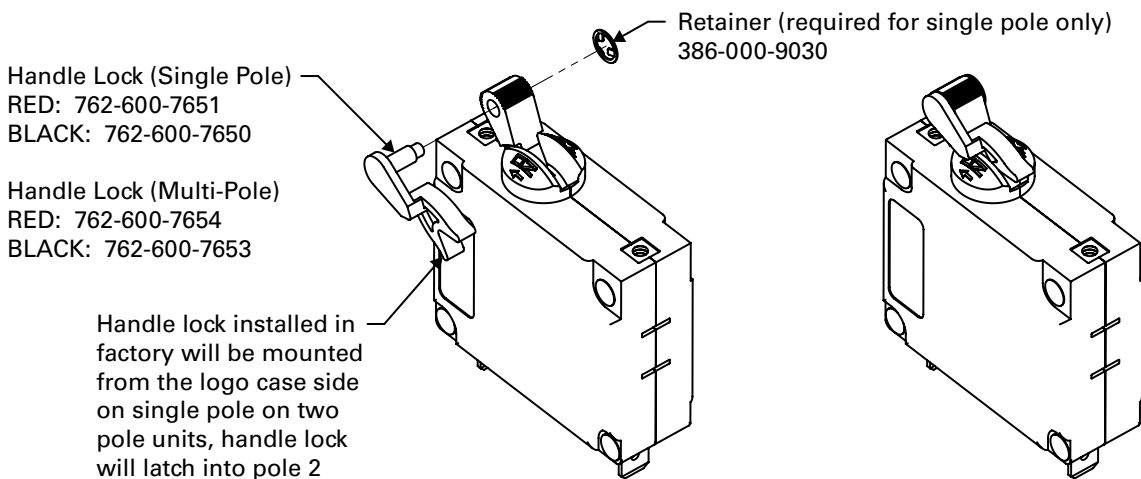

DELAY CURVES

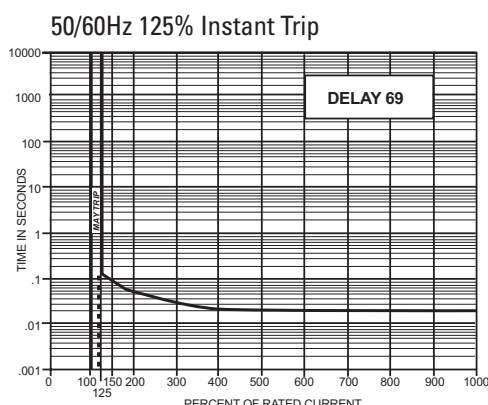
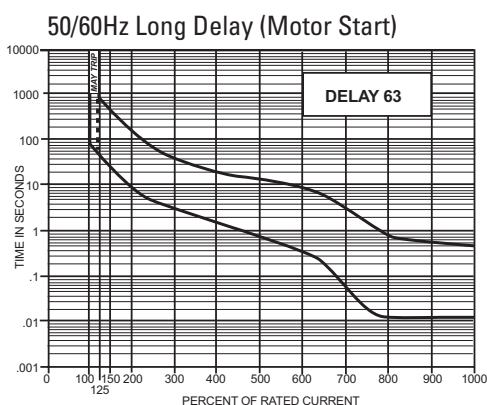
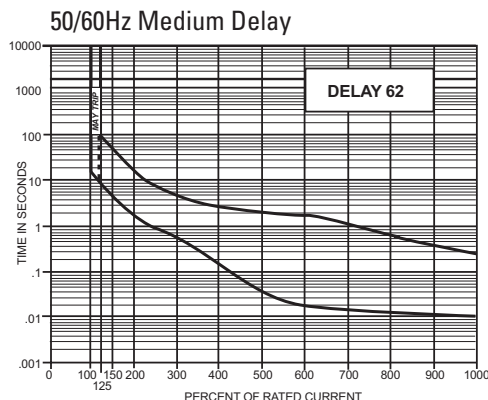
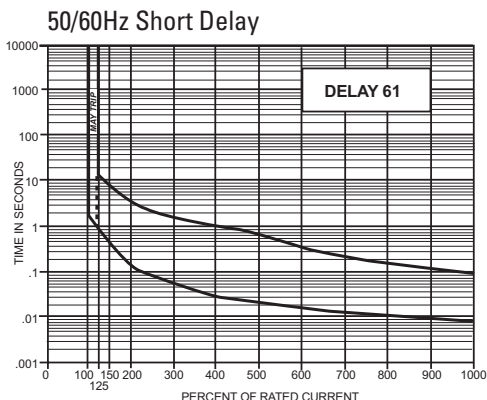

PERCENTAGE OF RATED CURRENT VS TRIP TIME IN SECONDS

| Delay | 100% | 125% | 150% | 200% | 400% | 600% | 800% | 1000% |
|-------|---------|------------|------------|-------------|-----------|------------|-------------|------------|
| 61 | No Trip | .700 to 12 | .35 to 7.0 | .130 to 3.0 | .030 to 1 | .015 to .3 | .01 to .15 | .008 to .1 |
| 62 | No Trip | 10 to 120 | 6 to 60 | 2 to 20 | .2 to 3.0 | .015 to 2 | .015 to .8 | .01 to .25 |
| 63 | No Trip | 50 to 700 | 30 to 400 | 10 to 150 | 1.5 to 20 | .015 to 10 | .013 to .85 | .013 to .5 |
| 69 | No Trip | 0.120 max | 0.100 max | 0.050 max | 0.022 max | 0.017 max | 0.017 max | 0.017 max |

INRUSH PULSE TOLERANCE

| Delay | Pulse Tolerance |
|------------|---------------------------------|
| 61, 62, 63 | 10 times rated current (approx) |

The table above provides a comparison of inrush pulse tolerance for each of the 50/60Hz delays. Pulse tolerance is defined as a single pulse of half sine wave peak current amplitude of 8 milliseconds duration that will not trip the circuit breaker. Consult Sensata Technologies for further assistance.

TYPICAL RESISTANCE / IMPEDANCE

| Current Ratings (Amps) | Impedance | DCR and Impedance based on 100% rated current applied and stabilized for a minimum of one hour. Tolerance .05-2.5 amperes ± 20%; 2.6-20 amperes ± 25%. Consult factory for special values and for coil impedance of delays not shown. |
|------------------------|--------------------------------------|---|
| | AC, 50/60Hz (ohms) 61, 62, 63, 69 | |
| 2.00 | 0.29 | |
| 5.00 | 0.051 | |
| 10.0 | 0.016 | |
| 20.0 | 0.006 | |

DECISION TABLES

| 1. Type & Handle | | | | | |
|------------------|---|---|---|--------------------|--|
| Step 1a | | Step 1b (optional) | | Step 1c (optional) | |
| LEJ | One Handle per Unit, UL 489 Listed, CSA, TÜV* | | Standard toggle & mounting (no entry, proceed to step 1c) | F | Flat bus connect screw terminal (ex. LUJZXF) |
| LEJH | One Handle per Pole, UL 489 Listed, CSA, TÜV* | BX | BX flat rocker with integral mounting | A | Low depth construction (ex. LEJA) |
| | | ZX | ZX rocker with integral mounting | | |
| LUJ | One Handle per Unit, UL 489 Listed | <i>* TÜV approval (EN60947-2) requires "T" added to end of part number</i> <i>"ZX" & "BX" versions are single handle construction only. 2-pole units handle may be located on either pole, other than standard handle locations shown. Units must be ordered as non descript part numbers.</i> | | | |
| LUJH | One Handle per Pole, UL 489 Listed | | | | |

| 2. Poles & Terminals | |
|----------------------|--------------------------------------|
| 1 | Single Pole, Quick Connect Terminals |
| 11 | Two Poles, Quick Connect Terminals |
| 6 | Single Pole, Screw Terminals |
| 66 | Two Poles, Screw Terminals |

| 3. Internal Configuration | |
|---------------------------|--------|
| 1 | Series |

| 4. Frequency & Delay | |
|----------------------|----------------------------------|
| 61 | 50/60Hz Short Delay |
| 62 | 50/60Hz Medium Delay |
| 63 | 50/60Hz Long Delay (Motor Start) |
| 69 | 50/60Hz 125% Instant Trip |

| 5. Rated Current | |
|--|--|
| Use three numbers in build (2.00 or 15.0 or 20.0) | |
| Required value between 2.00 amps minimum and 20.0 amps maximum, full integers only | |
| (specials available upon request) | |

| 6. Additional Options | |
|-----------------------|--|
| | Standard hardware, no options required |
| A | Metric thread mounting inserts and terminal hardware |
| G | Handle guard w/ limited access (available for ZX & BX versions only) |
| M | Handle in opposite pole (2-pole only) |
| Z | Optional "Z" barrier (not available on "A" low depth) |

| 8. Approvals | |
|--------------|--|
| T | TÜV approved Certified to EN60947-2 Includes the CE mark |

LEJBXA 66-1-62-20.0-AG-M6-T

7. Handle Colors, Indicators & Markings

Toggle Handle

| Unmarked | Marked ON - OFF I - O | Handle Color | Unmarked | Marked ON - OFF I - O | Handle Color | Unmarked | Marked ON - OFF I - O | Handle Color | Unmarked | Marked ON - OFF I - O | Handle Color |
|----------|-----------------------------|-----------------|----------|-----------------------------|-----------------|----------|-----------------------------|-----------------|----------|-----------------------------|-----------------|
| - 00 | - 01 | Black | - 10 | - 11 | Yellow | - 20 | - 21 | Red | - 30 | - 31 | Blue |
| - 40 | - 41 | Green | - 60 | - 61 | Orange | - 90 | - 91 | White | | | |

ZX Rocker Handle (Two-Color Rocker, Marking Detail "A")

| Vertical Mount ON - OFF <i>(fig 1)</i> | Vertical Mount I - O <i>(fig 2)</i> | Vertical Mount ON - OFF I - O <i>(fig 3)</i> | Horizontal Mount ON - OFF <i>(fig 4)</i> | Horizontal Mount I - O <i>(fig 5)</i> | Horizontal Mount ON - OFF I - O <i>(fig 6)</i> | Handle Color | Indicating Color | Marking Color | Indicates |
|--|---|---|--|---|---|-----------------|---------------------|------------------|-----------|
| - F1 | - F2 | - F3 | - F4 | - F5 | - F6 | Black | White | White | OFF |
| - G1 | - G2 | - G3 | - G4 | - G5 | - G6 | Black | Red | White | OFF |

BX Rocker Handle (Two-Color Rocker, Marking Detail "A")

| Vertical Mount ON - OFF <i>(fig 1)</i> | Vertical Mount I - O <i>(fig 2)</i> | Vertical Mount ON - OFF I - O <i>(fig 3)</i> | Horizontal Mount ON - OFF <i>(fig 4)</i> | Horizontal Mount I - O <i>(fig 5)</i> | Horizontal Mount ON - OFF I - O <i>(fig 6)</i> | Handle Color | Indicating Color | Marking Color | Indicates |
|--|---|---|--|---|---|-----------------|---------------------|------------------|-----------|
| - | - M2 | - M3 | - | - | - M6 | Black | White | White | OFF |
| - | - N2 | - N3 | - | - | - N6 | Black | Red | Red | OFF |

For BX: Bezel of BX is black. BX markings are same color as indicating color. Consult factory for other marking options.
For ZX: Black, red, blue and green handles have white marking. White, yellow and orange handles have black marking.

Note, these are just a few of the options/orientations/colors available, please consult the factory for additional information.

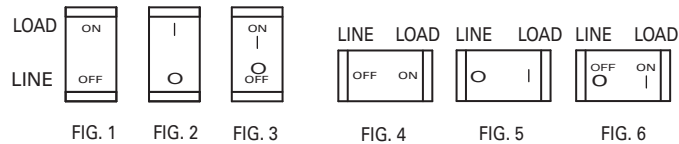

MARKING DETAIL "A"

NOTE: "ON" actuates towards the "up" and "right" direction

AIRPAX®

IAL/CEL/LEL Series Magnetic Circuit Protectors



- Introduction* • 147
- Poles* • 148
- Handles* • 150
- Configurations* • 154
- Operating Characteristics* • 157
- Delay Curves* • 159
- Specifications* • 163
- Decision Tables* • 165



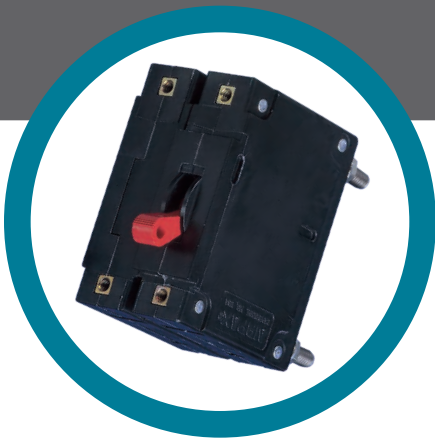

AIRPAX® | IAL/CEL/LEL Series Hydraulic Magnetic Circuit Protectors

INTRODUCTION

IAL/IUL/IEL/LEL magnetic circuit protectors provide low-cost power switching, reliable circuit protection and accurate circuit control for equipment in the international marketplace.

IAL models are for those applications where the unit's inherent attributes are desired, but compliance with the various standards is not required.

IUL models have been tested and approved in accordance with UL 1077 requirements for UL recognition.

IEL/LEL models are VDE approved to VDE 0660, part 101. They meet IEC spacing requirements, mandatory for equipment which must comply with IEC specifications 601 and 950, and VDE specifications 0804 and 0805. In addition, the IEL models are UL recognized to UL 1077 as supplementary protectors and

the LEL models are UL listed under the conditions of UL 489. Both are CSA certified and CCC Approved. The IEL is CSA certified as a supplementary protector per CSA C22.2–No. 235.

The CEL model has achieved two new enhancements, including a single pole, 125 amp rating with TÜV approval, and a parallel 4-pole version with 400 amp rating.

Airpax™ IAL/CEL/LEL circuit protectors are available in a wide variety of configurations, including series, series with auxiliary switch, shunt and relay with choice of delays and ratings in DC and/or 50/60Hz or 400Hz versions. Single or multi-pole versions are available with a variety of pole arrangements to meet your specifications. Please see the appropriate product specification table for ratings and limitations.

SINGLE POLE, STANDARD STUD TERMINAL

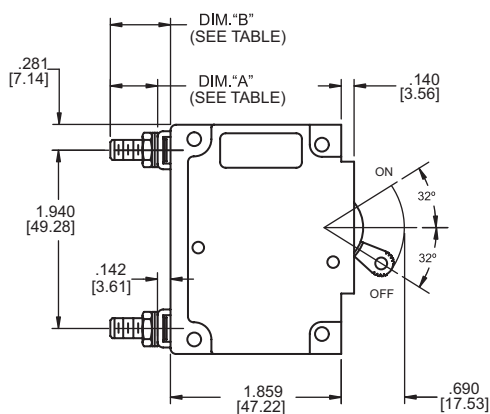

| STUD TERMINAL TYPES | | |
|---------------------|-------------------------------|-------------------------------|
| Screw Stud Thread | Dimension "A" | Dimension "B" |
| M6 | .510 ± .045 [12.95 ± 1.14] | .652 ± .035 [16.56 ± 0.89] |
| 1/4 -20 | .545 ± .045 [13.84 ± 1.14] | .687 ± .035 [17.45 ± 0.89] |
| M5 | .510 ± .045 [12.95 ± 1.14] | .652 ± .035 [16.56 ± 0.89] |
| 10-32 | .545 ± .045 [13.84 ± 1.14] | .687 ± .035 [17.45 ± 0.89] |

Single Pole

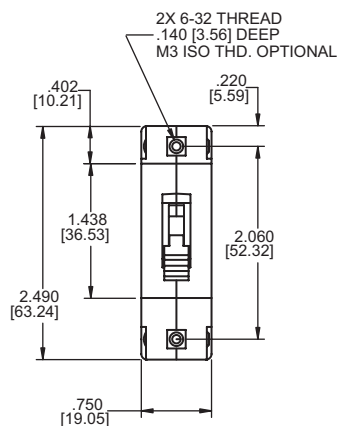

Mounting Detail

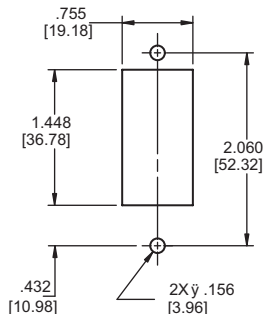

Panel Mounting Detail
Tolerance ±.005 [.13] unless noted.

Screw Terminal

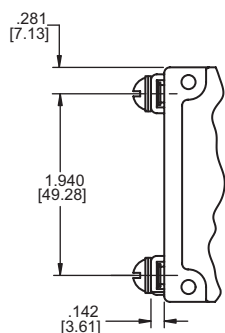

Clip Terminal

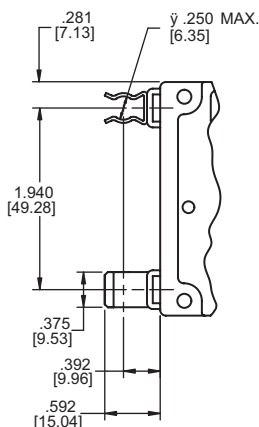

Bullet Terminal

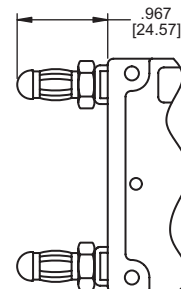

Notes:

Tolerance ± .015 [.39] unless noted.

Dimensions in brackets [] are millimeters.

A Terminal protrusion dimensions are referenced from back of mounting panel.

B Each screw terminal is supplied with a 10-32x.312 [7.92] or M5 x 8mm screw, flatwasher and external tooth lockwasher.

C Stud terminals are supplied with a flatwasher, external tooth lockwasher and a 10-32 or M5 hex nut (<=70A) (<=50A for LEL), 1/4-20 or M6 hex nut (>70A) (>50A for LEL).

Bullet terminal receptacle should be .312 ± .001 diameter hole not less than .250 depth. Contact Sensata for other bullet sizes.

Note: Each outer terminal is supplied with a flatwasher, tooth lockwasher and a hex nut.

MULTI-POLE CIRCUIT PROTECTORS

Multi-pole units are combined in an assembly with the trip mechanisms internally coupled. A fault in any protected circuit opens all poles simultaneously. Applications include use in polyphase circuits, single-phase three-wire systems, or in two or more related but electrically isolated circuits. A mix of delays, ratings and configurations are offered. The auxiliary switch is offered with either gold or silver contacts and is available when a series construction pole is specified.

Two Pole Units

An assembly consisting of two single pole units, having their trip mechanisms internally coupled, is available with either a single toggle handle or with a handle per pole. Please see decision one of the part number decision tables. Individual poles may vary in ratings, delays and internal configurations. If the poles are of series construction, an auxiliary switch may be included in either or both poles, allowing you to mix SELV and hazardous voltages.

Two Pole

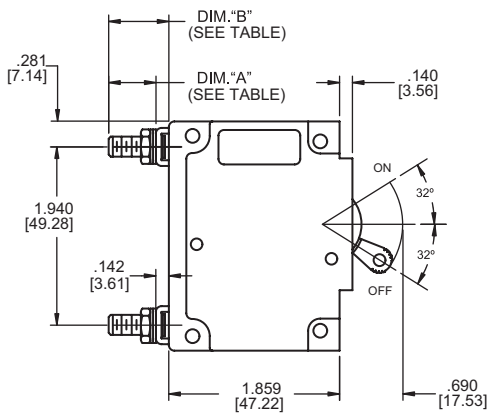

IELH11

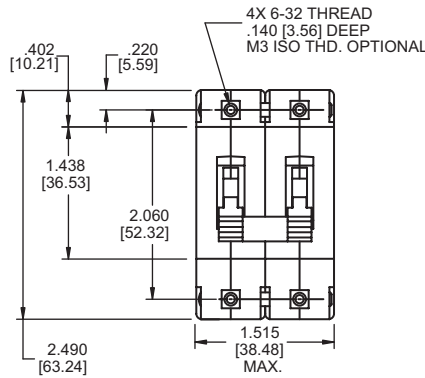

IEL11

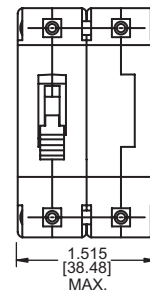

Note:
Tolerance $\pm .015$ [.38] unless noted.
Dimensions in brackets [] are millimeters.

| | | |
|-------------------|---------------------------------|---------------------------------|
| M6 | .510 | .652 |
| 1/4 - 20 | .545 | .687 |
| M5 | .510 | .652 |
| 10 - 32 | .545 | .687 |
| Screw stud thread | Dim. iA $\hat{}$ ($\pm .045$) | Dim. iB $\hat{}$ ($\pm .035$) |

Note:
Each outer terminal is supplied with a flatwasher, tooth lockwasher and a hex nut.

Two Pole*

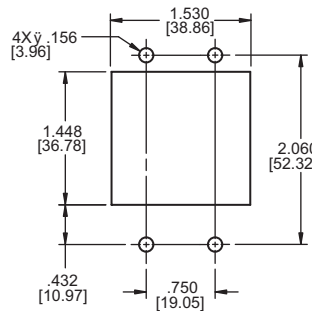

Two Pole*

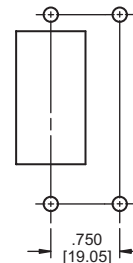

Panel Mounting Detail
Tolerance $\pm .005$ [.13] unless noted.

Note:
A Terminal protrusion dimensions are referenced from back of mounting panel.
B Each screw terminal is supplied with a 10-32x.312 [7.92] or M5 x 8mm screw, flatwasher and external tooth lockwasher.
C Stud terminals are supplied with a flatwasher, external tooth lockwasher and a 10-32 or M5 hex nut ($\leq 70A$), 1/4 -20 or M6 hex nut ($>70A$).

Three Pole and Four Pole Units

The three pole structure consists of three single pole units assembled with an internal mechanical interlock which actuates all units simultaneously. The units are available with either a single toggle handle or with a handle per pole. Units with four pole construction operate with a minimum of two center toggle handles or with a handle per pole. Please see decision one of the part number decision tables. Mixing of delays, ratings and configurations is available in each individual pole. The auxiliary switch is offered in any series trip pole.

Breaker poles are numbered consecutively when viewed from the terminal side, with the ON position up, starting with pole #1 on the left side and proceeding to the right.

Three Pole IEL111

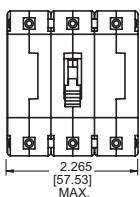

Three Pole IELH111

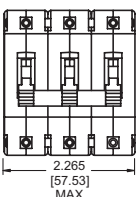

Four Pole IEL1111

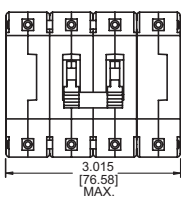

Four Pole IELH1111

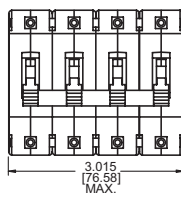

Panel Mounting Detail
Tolerance $\pm .005$ [.13] unless noted.

Mounting Detail*

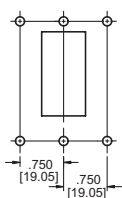

Mounting Detail*

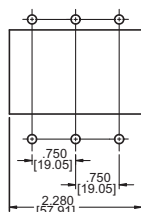

Mounting Detail*

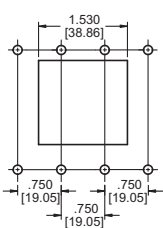

Mounting Detail*

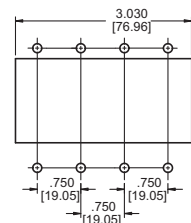

BX - FLAT ROCKER HANDLE

The innovative new design of our IAL/CEL/LEL BX Style circuit protectors features a flat rocker that will satisfy your aesthetic needs while guarding against accidental actuation, providing the highest degree of circuit protection and quality. Only Airpax offers this new standard in user interface. Available on a variety of versions with a full range of agency approvals, the IEL BX style circuit protectors meet or exceed all current performance specifications, including interrupting capacities up to 50,000 amperes.

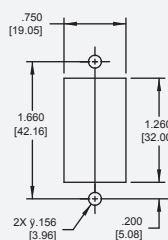
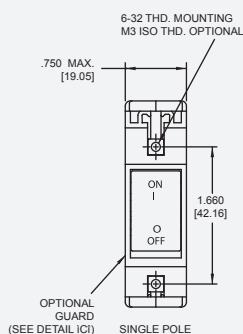
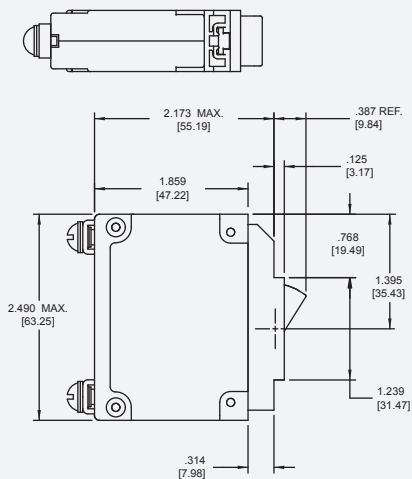

Panel Mounting Detail
Mounting Detail Tolerance:
 $\pm .005$ [.13] unless noted

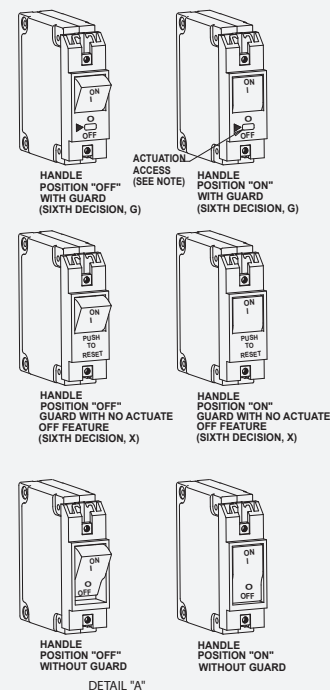

NOTE: ACCESS IS LIMITED TO A DEVICE SMALLER THAN THE UNDERWRITERS LABORATORY "ARTICULATED PROBE" DEFINED IN UL-489 FIG. 11.1.7.2.1.

Note:
Tolerance $\pm .015$ [.39] unless noted. Dimensions in brackets [] are millimeters.
*See Single Pole Mounting Detail for Hole Sizes and Locations.

LELHP/CELHP CIRCUIT PROTECTORS

The Airpax™ LELHP/CELHP high current magnetic circuit protector compliments our entire series of LEL circuit protectors. Its unique, parallel current sensing design provides precise current overload protection and reliability in the compact size of a two pole LEL. The unit is ideal for high power DC applications such as drive motor systems and telecommunication power systems.

LEL is available in series and series with auxiliary switch configurations with a choice of delays for DC ratings of 125, 150, 175 and 200 amperes. The CEL has been enhanced to include these same ratings plus a 4-pole, parallel 400 amp rating for UL489A. The LELHP is UL listed under the conditions of UL489 and CSA certified. The CELHP is UL listed under the conditions of UL489A. Mid-trip handle indication, voltage trip and remote operator options complete the LELHP/CELHP circuit breaker series. Please see the individual product tables for approved ratings.

Two Pole

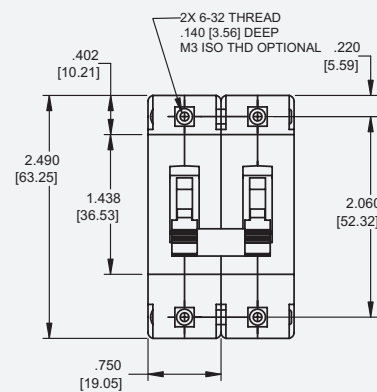
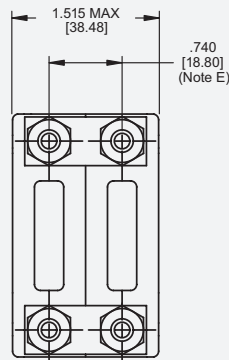
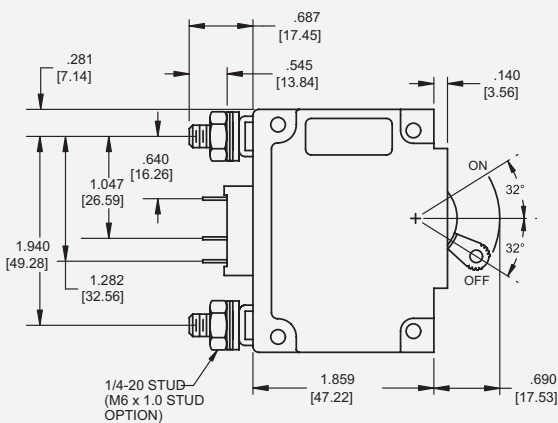

Three Pole (Note D)

Series Parallel



Series Parallel with optional 1REC4 Auxiliary switch

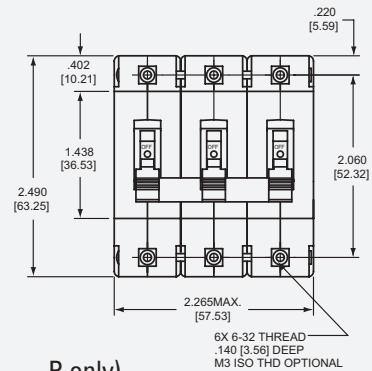
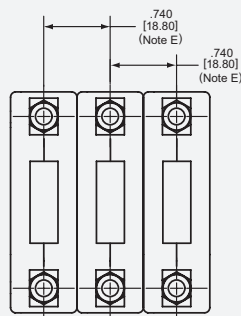
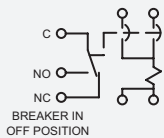

-REC4

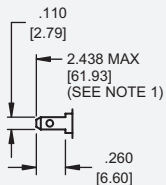

175/200 Parallel Pole

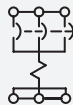

Four Pole (CEL __ P and CML __ P only)

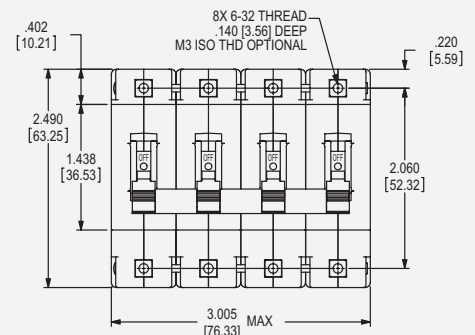
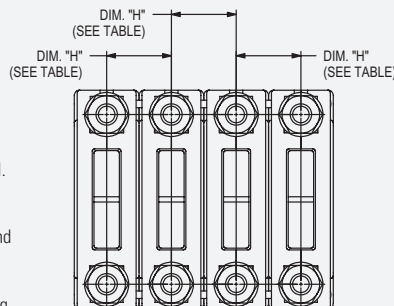

Notes:

- Tolerance $\pm .015$ [.39] unless noted. Dimensions in brackets [] are millimeters.
- A Terminal protrusion dimensions are referenced from back of mounting panel.
- B Each screw terminal is supplied with a 10-32x.312[7.92] or M5 x 8mm screw, flatwasher and external tooth lockwasher.
- C Stud terminals are supplied with a flatwasher, external tooth lockwasher and a 10-32 or M5 hex nut ($\leq 70A$), 1/4 -20 or M6 hex nut ($>70A$).
- D Units are supplied without bus bars must have a minimum copper strap (1 31/32 x 1/2 x 1/16) of appropriate length to accommodate connections tying each set of terminals together.
- E Other spacing available upon request. Contact factory for assistance.

IALN/IULN PANEL SEAL CIRCUIT PROTECTORS

The IALN/IULN family is a sealed toggle version of the IAL/IUL family. The silicone rubber seal around the handle assures panel seal integrity and makes this style a natural for harsh environments.

This sealed toggle family is available in one to three pole models with ratings of .050 to 100 amperes.

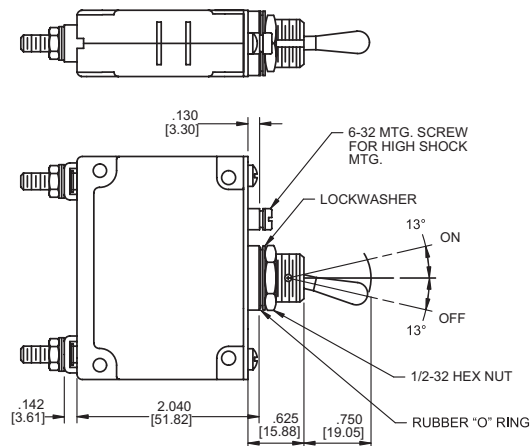

Single Pole

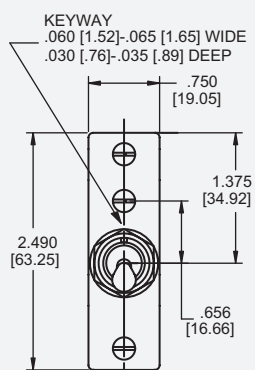

Two Pole

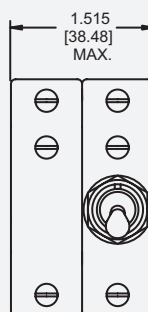

Three Pole

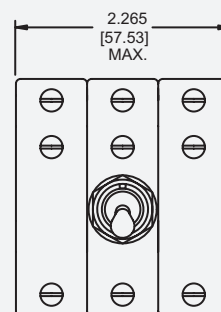

(Optional handle may be in pole 2 instead of pole 1.)

Panel Mounting Details: Tolerance $\pm .005$ [.13] Unless noted.

Single Pole

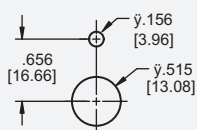

Two Pole*

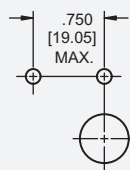

Three Pole*

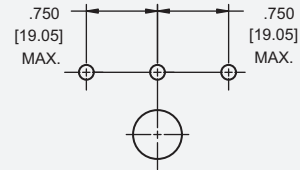

Optional handle

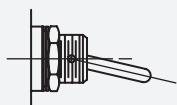

*See Single Pole Mounting Detail for Hole Sizes and Locations.

Notes:

- A Terminal protrusion dimensions are referenced from back of mounting panel.
- B Each screw terminal is supplied with a 10-32x.312[7.92] or M5 x 8mm screw, flatwasher and external tooth lockwasher.
- C Stud terminals are supplied with a flatwasher, external tooth lockwasher and a 10-32 or M5 hex nut (<=70A), 1/4 -20 or M6 hex nut (>70A).

IALX/IULX/IELX ROCKER HANDLE

The rocker style is available in one to four poles. Choose either vertical or horizontal mounting with ON-OFF, international markings or a combination of both.

Five front panel enhancing colors including black, white, red, grey and orange are available.

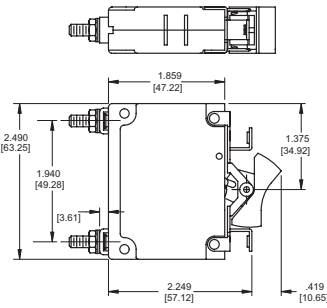

Single Pole

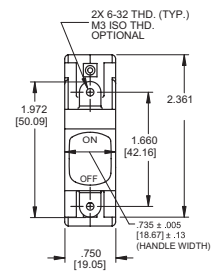

Two Pole

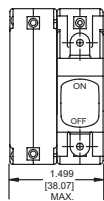

Three Pole

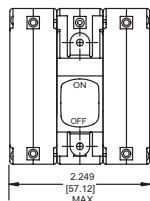

Four Pole

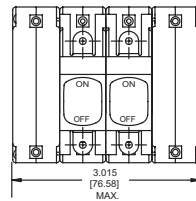

Panel Mounting Detail* Single, Two & Three Pole

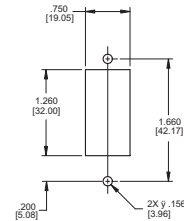

Four Pole**

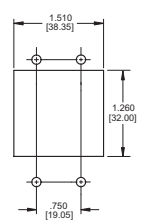

(Optional handle may be in Pole 2 instead of Pole 1.)

Note:

- A Terminal protrusion dimensions are referenced from back of mounting panel.
- B Each screw terminal is supplied with a 10-32x.312[7.92] or M5 x 8mm screw, flatwasher and external tooth lockwasher.
- C Stud terminals are supplied with a flatwasher, external tooth lock washer and a 10-32 or M5 hex nut (<=70A), ° -20 or M6 hex nut (>70A).

*Mounting detail tolerance $\pm .005$ [.13] Unless noted.

**See single mounting detail for hole sizes and locations.

IALZX/IULZX/IELZX ROCKER HANDLE

The IALZX/IULZX/IELZX style adds our rocker handle options of contrasting dual color rocker actuators, affording a clear visual indication of the handle position and integrated handle guards, to

help prevent accidental turn-on and turn-off of the unit. Available with a black rocker and white, red or green indicator color for either ON or OFF indication.

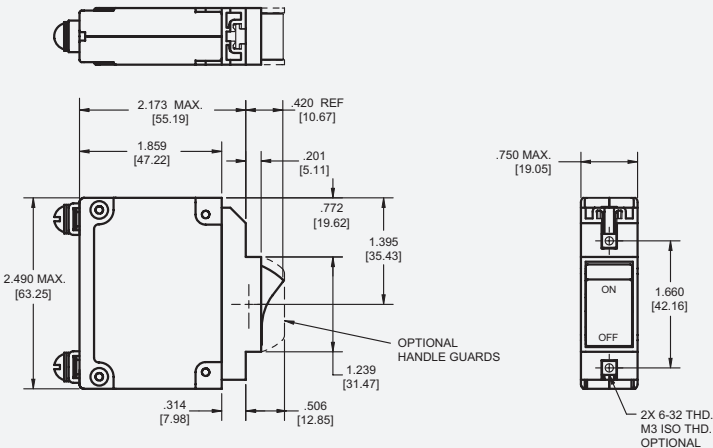

Panel Mounting Detail

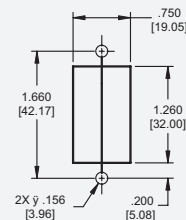

Note: Tolerance $\pm .015$ [.38] unless noted.
Dimensions in brackets [] are millimeters.

Panel Mounting Detail
Tolerance $\pm .005$ [.13] unless noted.

CONFIGURATIONS

Series Trip

The most popular configuration for magnetic protectors is the series trip where the sensing coil and contacts are in series with the load being protected. The handle position conveniently indicates circuit status. In addition to providing conventional overcurrent protection, it's simultaneously used as an on-off switch.

Shunt Trip

The shunt trip is designed for controlling two separate loads with one assembly. The control is established by providing overload protection for the critical load. When the current through this load becomes excessive and reaches the trip point, the protector will open and remove power from both loads simultaneously. The total current rating of both loads must not exceed the maximum contact rating.

Dual Coil

By combining two electrically independent coils on a common magnetic circuit, it is possible to provide contact opening when either an over-current or trip voltage is applied to the respective coils. One coil will be a current trip coil with standard specifications. The second, or dual coil, can be used to provide a control function permitting contact opening from a remote interlock or other transducer functions. Standard coils are 6, 12, 24, 48, 120 and 240 volts. Tripping is instantaneous and must be removed (usually self-interrupting) after trip.

Auxiliary Switch (Applies to Series Trip Only)

This is furnished as an integral part of a series pole in single or multi-pole assemblies. Isolated electrically from the protector's circuit, the switch works in unison with the power contacts and provides indication at a remote location of the protector's on-off status.

Auxiliary switch contacts actuate simultaneously with the main breaker contacts, and will open regardless of whether the breaker contacts are opened manually or electrically. For auxiliary switch ratings below 6Vac or 5Vdc, an auxiliary switch with gold contacts, designated as REG is available. Gold contacts are not recommended for load current above 100 milliamps.

Note:

- Terminal protrusion dimensions are referenced from back of mounting panel.
- Each screw terminal is supplied with a 10-32x.312[7.92] or M5 x 8mm screw, flatwasher and external tooth lockwasher.
- Stud terminals are supplied with a flatwasher, external tooth lock washer and a 10-32 or M5 hex nut ($\leq 70A$), 1/4-20 or M6 hex nut ($>70A$).

Series and Switch Only

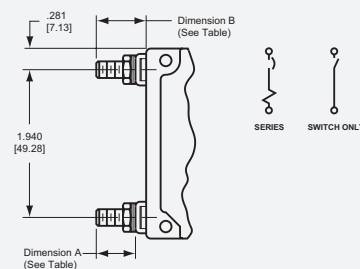

Series with Auxiliary Switch

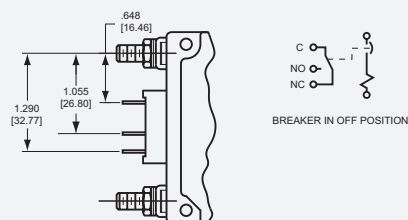

STUD TERMINAL TYPES

| Screw Stud Thread | Dimension "A" | Dimension "B" |
|-------------------|-------------------------------|-------------------------------|
| M6 | .510 ± .045 [12.95 ± 1.14] | .652 ± .035 [16.56 ± 0.89] |
| 1/4 -20 | .545 ± .045 [13.84 ± 1.14] | .687 ± .035 [17.45 ± 0.89] |
| M5 | .510 ± .045 [12.95 ± 1.14] | .652 ± .035 [16.56 ± 0.89] |
| 10-32 | .545 ± .045 [13.84 ± 1.14] | .687 ± .035 [17.45 ± 0.89] |

Shunt and Dual Coil

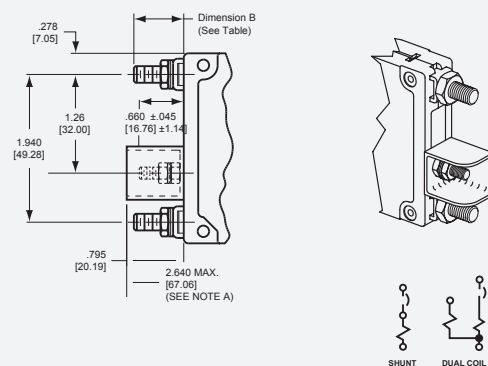

Spacing for VDE Switch

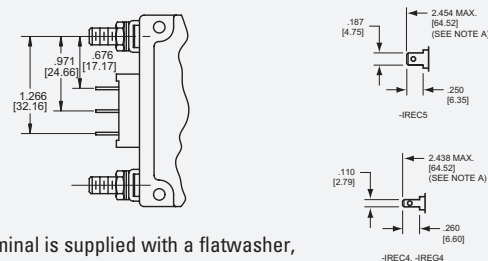

Note: Each outer terminal is supplied with a flatwasher, tooth lockwasher and a hex nut.

CONFIGURATIONS (CONT.)

Relay Trip

This permits the overload sensing coil to be placed in a circuit which is electrically isolated from the trip contacts. The coil may be actuated by sensors monitoring pressure, flow, temperature, speed, etc. Other typical applications include crowbar, interlock and emergency/rapid shutdown circuitry. Trip may be accomplished by voltage or current, which must be removed after trip.

Voltage Trip

Sometimes called "dump circuits" or "panic trip circuits," these units make it possible to open main power contacts with lower power inputs from one or more sources. This configuration is becoming increasingly more important for sensitive circuitry and denser packaging in automation systems. Available in series, shunt or relay configurations.

Relay and Dual Coil

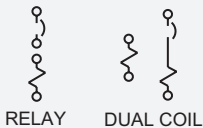
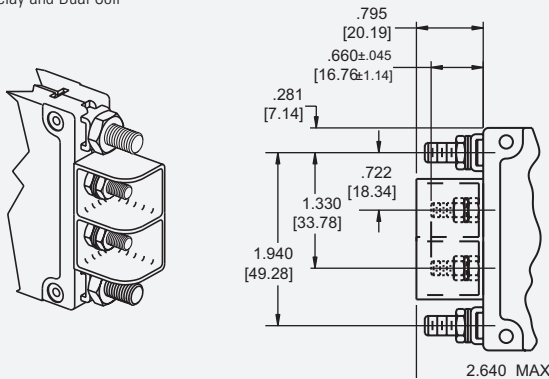

Notes:

- Tolerance $\pm .015$ [3.9] unless noted. Dimensions in brackets [] are millimeters.
- A Terminal protrusion dimensions are referenced from back of mounting panel.
- B Each screw terminal is supplied with a 10-32x.312[7.92] or M5 x 8mm screw, flatwasher and external tooth lockwasher.
- C Stud terminals are supplied with a flatwasher, external tooth lockwasher and a 10-32 or M5 hex nut ($\leq 70A$), 1/4 -20 or M6 hex nut ($>70A$).

Barriers

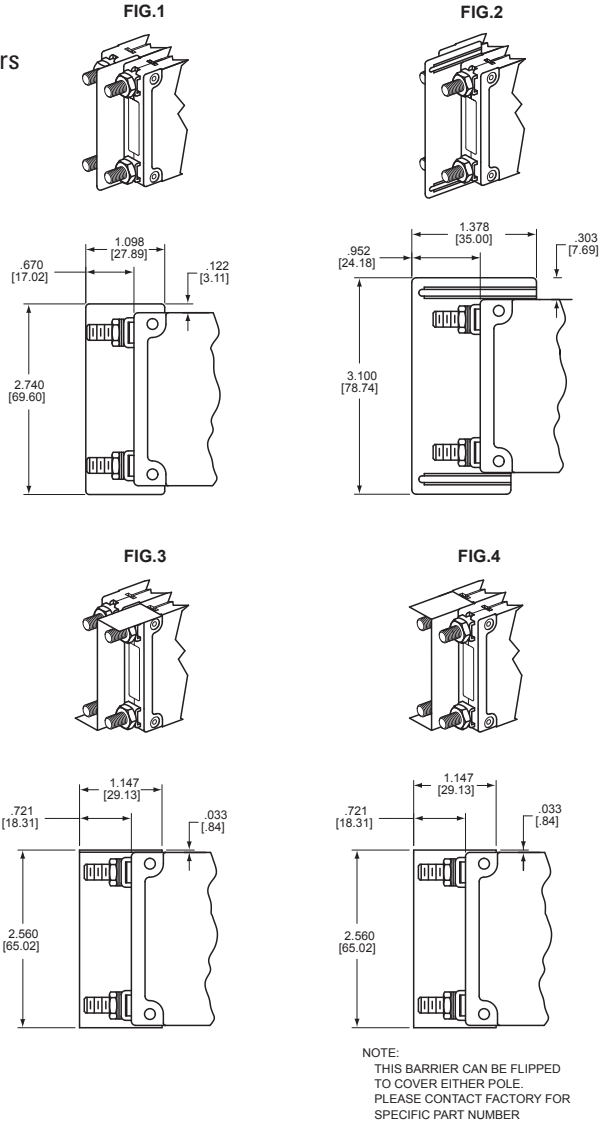

NOTE:
THIS BARRIER CAN BE FLIPPED TO COVER EITHER POLE. PLEASE CONTACT FACTORY FOR SPECIFIC PART NUMBER

BARRIER OPTIONS

| Rating Option | Standard Barrier | Optional Barrier |
|---|------------------|------------------|
| IEL | | |
| 240/415 VAC | Fig. 1 | Fig. 2, 3 & 4 |
| 415 VAC (VDE) | | |
| 277/480 VAC | | |
| 1/4-20, M6 studs for AC | Fig. 2 | Fig. 3 & 4 |
| 120/240 VAC multi-pole | | |
| 125VDC | | |
| LEL | | |
| All multi-pole 50/60 Hz | Fig. 2 | Fig. 3 & 4 |
| All multi-pole 80 VDC, if opposite polarity | Fig. 2 | Fig. 3 & 4 |
| 125VDC | Fig. 2 | Fig. 3 & 4 |

Note: Optional barrier available with factory assigned part number. Contact factory for assistance.

Mid-Trip Indication

Circuit protection, rapid fault location and alarm capability are blended together in the Airpax mid-trip indication option. This option is designed for automatic handle movement to a middle position upon electrical overload, allowing for easier detection of the fault circuit and minimizing downtime due to the overload condition.

In the optional auxiliary switch configuration, the switch allows an alarm or signal to be forwarded when the breaker trips and the handle moves to the middle position. The alarm can be disengaged by the manual actuation of the handle to the OFF position. Once the fault has been corrected, the circuit breaker can be reset to the ON position. The mid-trip option is available in one, two or three pole toggle handle packages and in either standard panel screw or snap-in mounting. Please see specification tables of specific product for available ratings.

Snap-In Mounting

The snap-in mounting adapter allows for simplified mounting of most IEL/LEL toggle handle products. Prior to shipment, the adapter is attached to the circuit breaker during our final product assembly, allowing you to securely snap the unit into a rectangular panel cut-out. This eliminates the need for panel mounting hardware and associated assembly costs.

Available for units up to three poles, with or without an option handle guard.

Note: Tolerance $\pm .015$ [.39] unless noted.
Dimensions in brackets [] are millimeters.

Panel Mounting Detail
Tolerance $\pm .005$ [.13] unless noted.

Mid-Trip Handle Positions

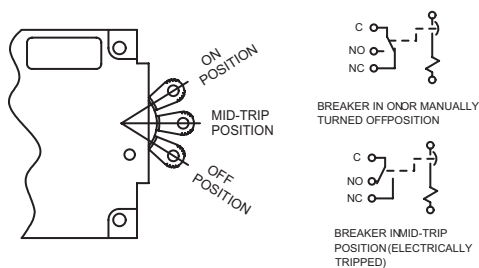

Panel Mounting Detail

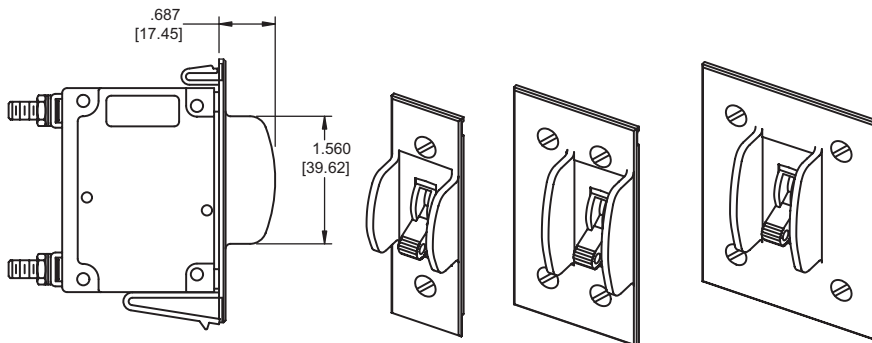
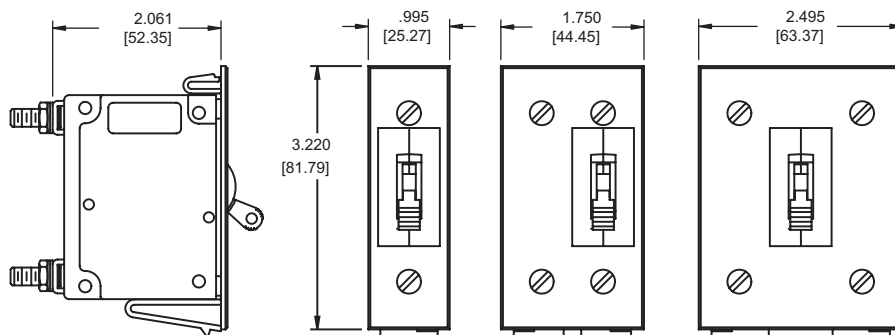
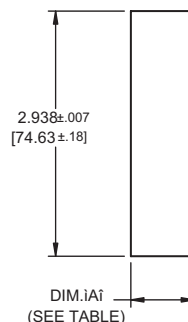

| PANEL MOUNTING OPTIONS | | |
|------------------------|---------------------------------------|-------------------------------------|
| # of Poles | Dimension "A" | Panel Thickness |
| 1 pole | .760 \pm .007 [19.30 \pm .18] | .062 \pm .005 [1.57 \pm .13] |
| 2 pole | 1.530 \pm .007 [38.86 \pm .18] | .062 \pm .005 [1.57 \pm .13] |
| 3 pole | 2.280 \pm .007 [57.91 \pm .18] | .062 \pm .005 [1.57 \pm .13] |

OPERATING CHARACTERISTICS

| NOMINAL DCR /IMPEDANCE | | | |
|---------------------------|-------------------|--------------------|------------------|
| Current Ratings (Amps) | Resistance (ohms) | Impedance (ohms) | Impedance (ohms) |
| | DC Delays | AC, 50/60Hz Delays | AC, 400Hz Delays |
| | 51, 52, 53, 59 | 61, 62, 63, 69 | 41, 42, 43, 49 |
| 0.20 | 45.8 | 28.5 | 71.94 |
| 1.0 | 1.38 | 1.10 | 2.85 |
| 2.0 | 0.371 | 0.29 | 0.76 |
| 5.0 | 0.055 | 0.051 | 0.12 |
| 10.0 | 0.017 | 0.016 | 0.032 |
| 20.0 | 0.006 | 0.006 | 0.010 |
| 30.0 | 0.003 | 0.004 | 0.006 |
| 50.0 | 0.0019 | 0.0018 | 0.0019 |
| 60.0 | 0.00157 | 0.00134 | — |
| 70.0 | 0.00147 | 0.00133 | — |
| 80.0 | 0.00146 | 0.00123 | — |
| 90.0 | 0.00135 | 0.00114 | — |
| 100.0 | 0.00135 | 0.00114 | — |
| 125.0 | 0.0005 | — | — |
| 150.0** | 0.0005 | — | — |
| 165.0** | 0.0004 | — | — |
| 175.0** | 0.0004 | — | — |
| 200.0** | 0.0004 | — | — |
| 250.0** | 0.0004 | — | — |
| 400** | 0.0003 | — | — |

Notes:
 DCR and impedance based on 100% rated current applied and stabilized a minimum of one hour.
 No 53 delay on 125 amp single pole or 400 amp four pole devices
 Tolerance: .02 amperes to 2.5 amperes, ± 20%; 2.6 amperes to 20 amperes, ± 25%; 21 amperes to 50 amperes, ± 50%. Consult factory for special values and for coil impedance of delays not shown
 ** Paralleled poles only, 400 amps only available on CELHP

PERCENTAGE OF RATED CURRENT VS TRIP TIME IN SECONDS AT +25°C

| Delay | 100% | 125%* | 150% | 200% | 400% | 600% | 800% | 1000% |
|-------|---------|------------|-----------|------------|------------|-------------|-------------|-------------|
| 41* | No Trip | May trip | .5 to 8 | .15 to 1.9 | .02 to .4 | .006 to .25 | .004 to .1 | .004 to .05 |
| 42* | No Trip | May trip | 5 to 70 | 2.2 to 25 | .40 to 5 | .012 to 2 | .006 to .2 | .006 to .15 |
| 43* | No Trip | May trip | 35 to 350 | 12 to 120 | 1.5 to 20 | .012 to 2.2 | .01 to .22 | .01 to .1 |
| 49* | No Trip | May trip | .100 max. | .050 max. | .020 max. | .020 max. | .020 max. | .020 max. |
| 51 | No Trip | .5 to 6.5 | .3 to 3 | .1 to 1.2 | .031 to .5 | .011 to .25 | .004 to .1 | .004 to .08 |
| 52 | No Trip | 2 to 60 | 1.8 to 30 | 1 to 10 | .15 to 2 | .04 to 1 | .008 to .5 | .006 to .1 |
| 53** | No Trip | 80 to 700 | 40 to 400 | 15 to 150 | 2 to 20 | .23 to 9 | .015 to .55 | .012 to .2 |
| 59 | No Trip | .120 max. | .100 max. | .050 max. | .022 max. | .017 max. | .017 max. | .017 max. |
| 61 | No Trip | .7 to 12 | .35 to 7 | .130 to 3 | .030 to 1 | .015 to .3 | .01 to .15 | .008 to .1 |
| 62 | No Trip | 10 to 120 | 6 to 60 | 2 to 20 | .2 to 3 | .02 to 2 | .015 to .8 | .01 to .25 |
| 63 | No Trip | 50 to 700 | 30 to 400 | 10 to 150 | 1.5 to 20 | .4 to 10 | .013 to .85 | .013 to .5 |
| 69 | No Trip | .120 max | .100 max. | .050 max. | .022 max. | .017 max. | .017 max. | .017 max |
| 71 | No Trip | .44 to 10 | .3 to 7 | .100 to 3 | .030 to 1 | .012 to .3 | .004 to .15 | .004 to .1 |
| 72 | No Trip | 1.8 to 100 | 1.7 to 60 | 1 to 20 | .15 to 3 | .015 to 2 | .008 to .79 | .006 to .28 |
| 73 | No Trip | 50 to 600 | 30 to 400 | 10 to 150 | 1.8 to 20 | .015 to 10 | .015 to .88 | .011 to .5 |
| 79 | No Trip | .120 max | .100 max. | .050 max. | .023 max. | .016 max. | .015 max. | .015 max |

Notes:

All trip curves and trip currents are specified with the protector mounted in the normal vertical position at ambient temperature of +25° C. Protectors do not carry current prior to application of overload. A: Ratings above 30 amps may deviate from the above limits by approximately 10% (130% for delay 49).

* No 53 delay on 125 amp single pole or 400 amp four pole devices

* 135% for delay 71, 72, 73 & 79

DELAY CURVES

400Hz, DC, 50/60Hz Delay Curves (typ)

A choice of delays is offered for DC, 50/60Hz, 400Hz, or combined DC/50/60Hz applications. Delays 49, 59, 69 and 79 provide fast-acting, instantaneous tripping and are often used to protect sensitive electronic equipment (not recommended where a known inrush exists). Delays 41, 51, 61 and 71 have a short delay for general purpose applications. Delays 42, 52, 62 and 72 are long enough for most transformers and capacitor loads. Delays 43, 53, 63 and 73 are extra long for special motor applications.

Inrush Pulse Tolerance

Pulse tolerance is defined as a single pulse of half sine wave peak current amplitude of 8 milliseconds duration that will not trip the circuit breaker.

The table on page 171 provides a guide to determine if the inertia delay feature is required. Consult factory for further assistance.

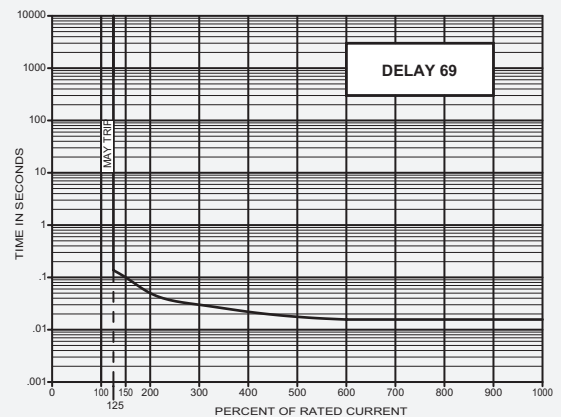
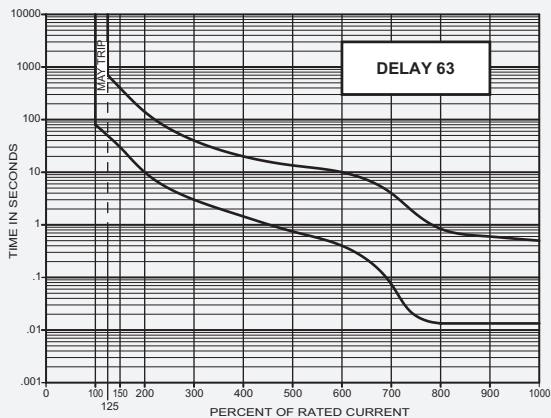
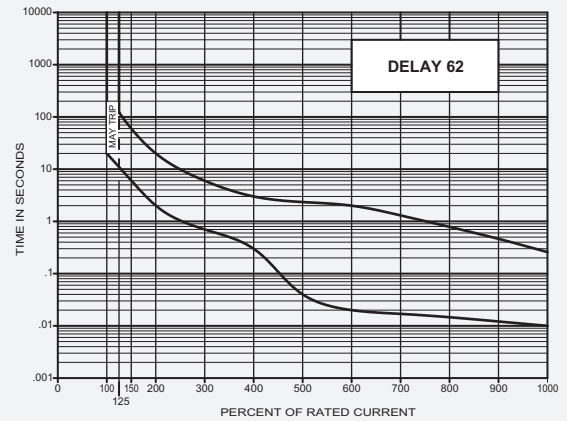
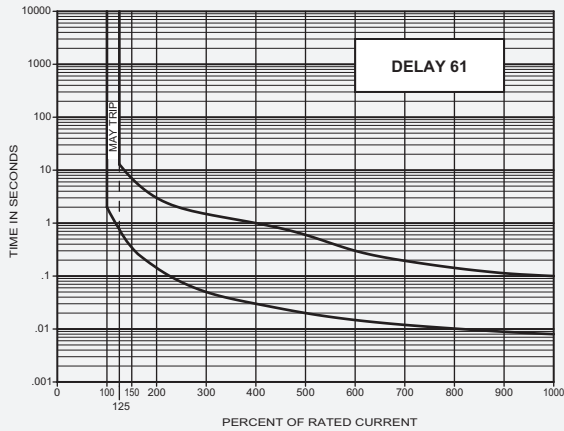

DC Delay Curves (typ)

| PULSE TOLERANCES | |
|------------------------------|----------------------------------|
| Delay | Pulse Tolerance |
| 61, 62, 63, 71, 72, 73 | 10 times (approx.) rated current |
| 61F, 62F, 63F, 71F, 72F, 73F | 12 times (approx.) rated current |
| 64, 65, 66 (0 - 50A) | 25 times (approx.) rated current |
| 64, 65, 66 (>50 - 80A) | 20 times (approx.) rated current |
| 64, 65, 66 (>80 - 100A) | 18 times (approx.) rated current |

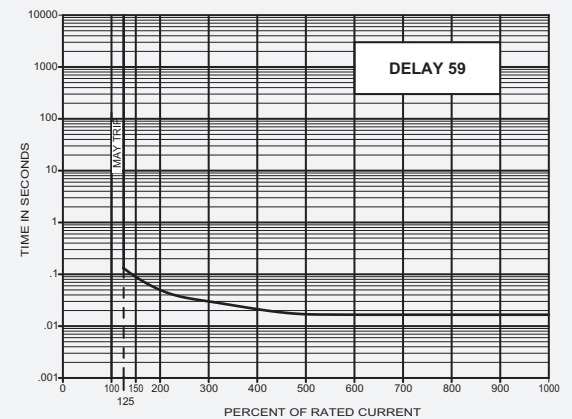
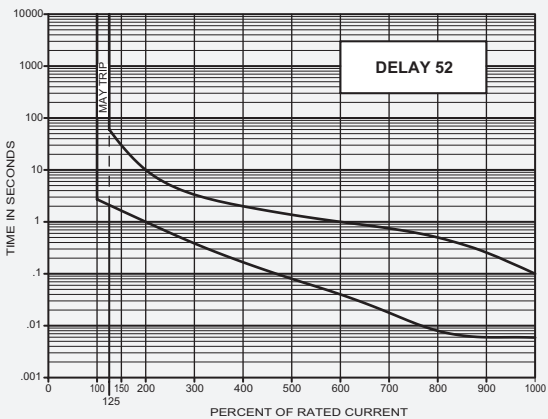
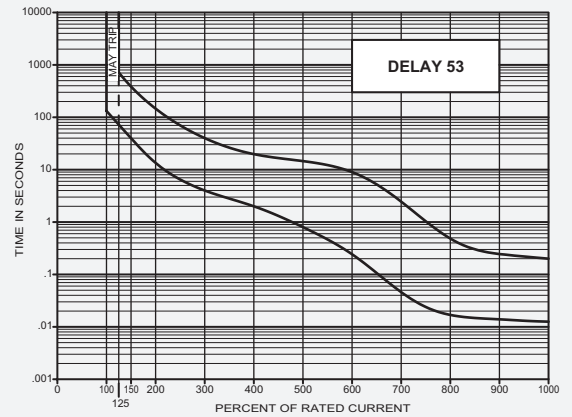
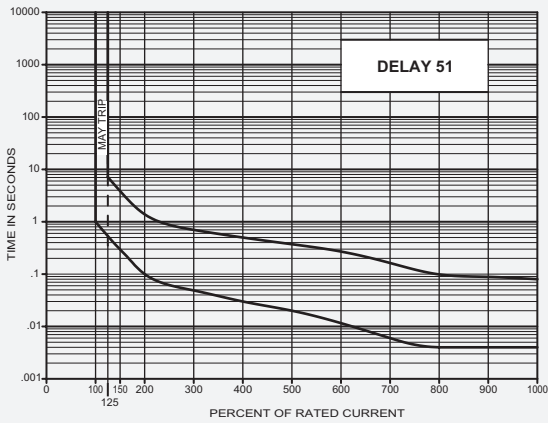

400Hz Delay Curves (typ)

*Available only in IAL/IUL/IEL; not available in LEL.

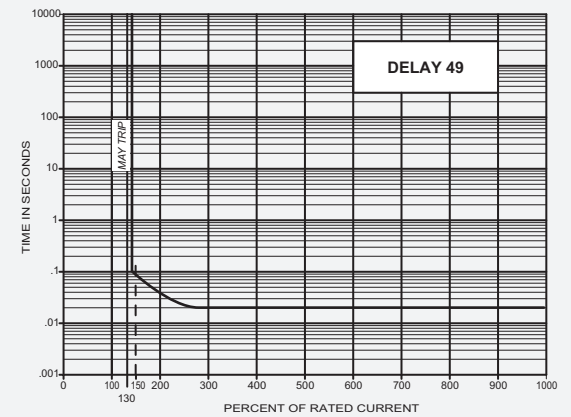
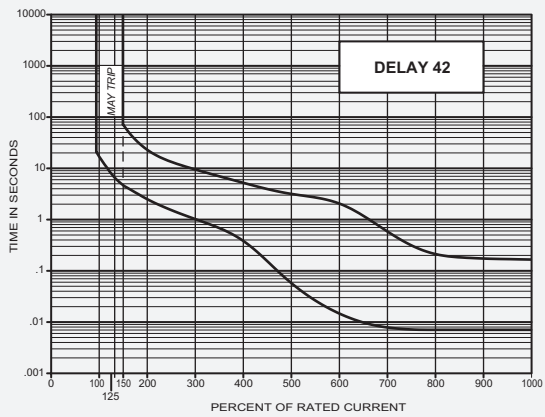
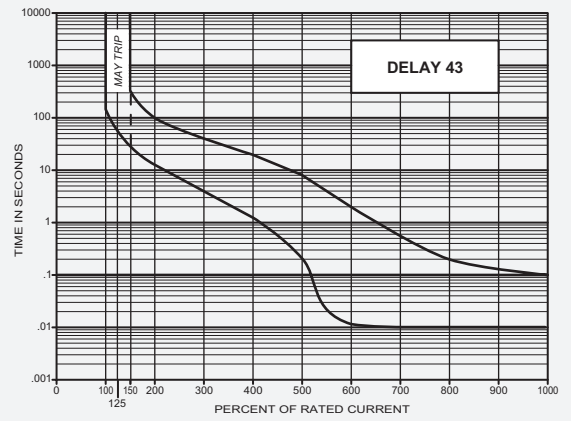
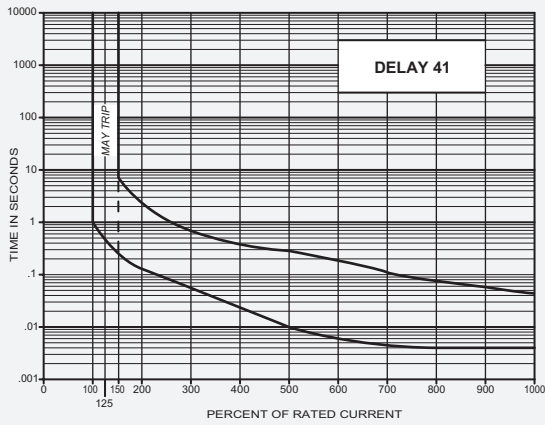

DC/50/60Hz Dual-frequency Delay Curves (typ)

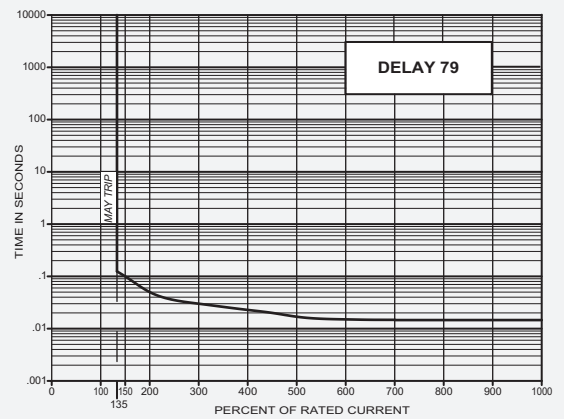
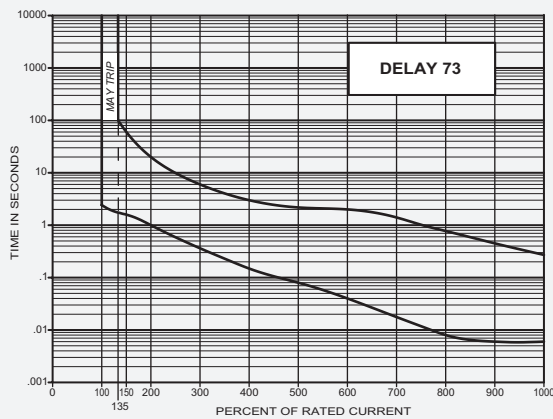
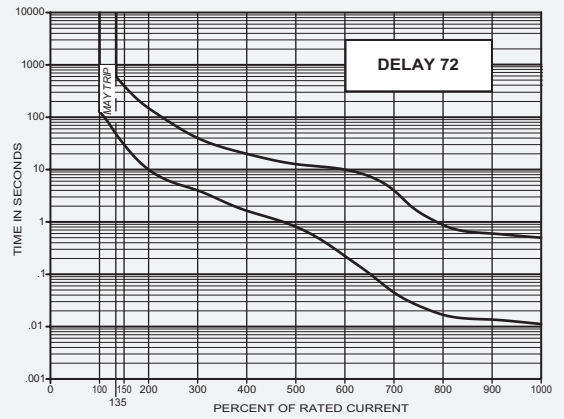
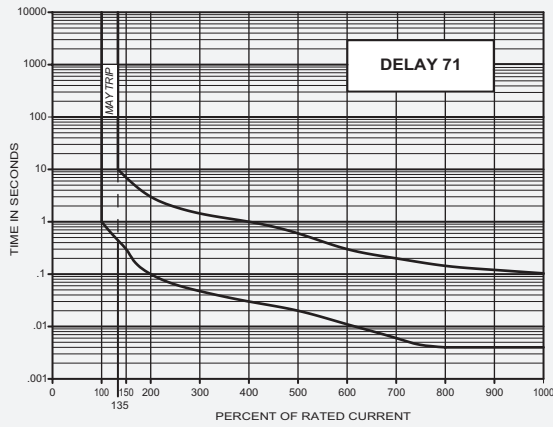

IAL/IUL/IEL/IDL/LEL SPECIFICATIONS

Trip Free

Will trip open on overload even when forcibly held in the ON position. This prevents the operator from damaging the circuit by holding the breaker on.

Trip Indication

The operating handle moves positively to the OFF or mid-trip position on electrical overload.

Ambient Operation

IAL/IUL/IEL protectors operate in temperatures between -40°C to $+85^{\circ}\text{C}$.

Insulation Resistance

Not less than 100 megohms at 500 volts DC.

Dielectric Strength

IAL/IUL/IEL protectors withstand 3750Vac (1250Vac for LEL), 60Hz for 60 seconds between all electrically isolated terminals except auxiliary switch terminals shall withstand 600Vac, 60Hz for REG and REC types. Four terminal dual coil and relay construction (not offered in the LEL) will withstand 1500Vac.

Endurance

Operating as a switch, the operating life exceeds 10,000 operations, 6000 at rated load, 4000 without load, at a rate of 6 per minute.

Electrical Characteristics

.050-100 amperes 80Vdc, 240Vac Max., 240/415Vac at 50 amperes Max., 50/60Hz and 400Hz. Consult factory for specific product ratings. Units rated for 240/415Vac and above 50 amperes are not suitable for across-the-line motor starting.

Poles

One through six poles available.

Construction

Series, shunt, relay dual coil and series with auxiliary switch available in various delays and combinations.

Auxiliary Switch

When supplied shall be S.P.D.T. configuration. Non VDE approved switches have a maximum UL rating of 10.0 amperes, 250 volts, 60Hz; 3.0 amperes, 50 volts DC (REC type) or 0.1 amperes, 125 volts, 60Hz (REG type).

VDE approved switches have a maximum UL rating of 10.0 amperes, 250 volts, 60Hz (REC type); or 0.1 amperes, 125 volts, 60Hz (REG type). The maximum VDE ratings are 1.0 amperes, 125 volts, 60Hz (REC type); 0.1 amperes, 125 volts, 60Hz (REG type).

Salt Spray (Corrosion)

Meet the requirements of MIL-PRF-55629 when tested in accordance with Method 101 of MIL-STD-202.

Moisture Resistance

Meet all the requirements of MIL-PRF-55629 when tested in accordance with Method 106 of MIL-STD-202.

Shock

Circuit protectors shall not trip when tested per MIL-STD-202, Method 213, Test Condition I with 100% rated current applied to delayed units and 80% rated current to instantaneous units.

Vibration

Circuit protectors shall not trip when vibrated per MIL-STD-202, Method 204, Test Condition A with 100% rated current applied to delayed units and 80% rated current to instantaneous units.

UL-1500 (Marine Ignition Protected)

The IDL/IDLH is approved for Marine Ignition Protection (series configuration only), covering ignition protected circuit breakers. This specification requires devices to be used in accordance with the requirements of U.S. Coast Guard and Fire Protection Standard for Pleasure and Commercial Motor Craft, ANSI/MFPA #302.

APPROXIMATE WEIGHT PER POLE

| Ounces | Grams |
|--------|-------|
| 3.1 | 90 |

RECOMMENDED TORQUE SPECIFICATIONS

| Component | Torque (in-lbs) |
|---------------------------|-----------------|
| 6-32 Mounting Inserts | 6 to 8 |
| M3 Mounting Screws | 4 to 5 |
| 10-32 Screw Terminals | 14 to 15 |
| M5 Terminal Screws | 14 to 15 |
| 10-32 Stud Terminals | 13 to 14 |
| M5 Stud Terminals | 13 to 14 |
| 1/4 - 20 Stud Terminals | 40 to 45 |
| M6 Stud Terminals | 40 to 45 |
| 1/2 - 32 Mounting Bushing | 30 to 35 |

Where applicable, mechanical support must be provide to the terminals when applying torque

IAL/IUL/IEL/IDL/LEL/LELHP SPECIFICATIONS

AGENCY APPROVALS - IAL/IUL/IEL

| Voltage | Frequency (Hz) | Phase | Min. Poles | TC | OL | UL/CSA | VDE (amps) | UL 1077 & CSA (AIC) | VDE (AIC) |
|------------|----------------|-------|------------|----|----|----------|------------|---------------------|-----------|
| 65 | DC | - | 1 | 1 | 1 | .02-100 | .10-70 | U2, 7500 | 4000 |
| 65(4) | DC | - | 1 | 1 | 1 | .02-100 | - | U2, 3000 | - |
| 65(4) | DC | - | 1 | 1 | 1 | .02-50 | - | U2, 5000 | - |
| 65 | DC | - | 2** | 2 | 1 | 101-150 | - | U2, 7500 | - |
| 80 | DC | - | 1 | 1 | 1 | .02-70 | .10-50 | U2, 7500 | 4000 |
| 80 | DC | - | 1 | 1 | 1 | 70.1-100 | - | U2, 5000 | - |
| 80 | DC | - | 2 | 1 | 1 | 101-150 | - | U1, 10000 | - |
| 80 | DC | - | 3 | 1 | 0 | 251-300 | - | U2, 7500 | - |
| 125 | DC | - | 2 | 1 | 0 | .02-100 | - | U2, 5000 | - |
| 250 | DC | - | 2+ | 1 | 0 | .02-50 | - | U1, 5000 | - |
| 300 | DC | - | 3++ | 1 | 0 | .02-50 | .10-50 | U2, 1000 | 5000 |
| 125 | 50/60 | 1 | 1 | 1 | 0 | .02-70 | - | U2, 5000 | - |
| 125 | 50/60 | 1 | 1 | 1 | 1 | .02-100 | - | U1, 3000 | - |
| 125(5) | 50/60 | 1 | 1 | 1 | 1 | .02-100 | - | U3, 1500 | - |
| 120/240 | 50/60 | 1 | 2 | 2 | 1 | .02-100 | - | U1, 2000 | - |
| 125/250(5) | 50/60 | 1 | 2 only | 1 | 1 | .02-100 | - | U3, 1500 | - |
| 240 | 50/60 | 1&3 | 1 | 1 | 0 | .02-70 | - | U1, 2000 | - |
| 240 | 50/60 | 3 | 2 | 1 | 1 | .02-100 | - | U2, 2000 | - |
| 250 | 50/60 | 3 | 1 | 1 | 1 | .02-50 | .10-100 | U2, 3000 | 2000 |
| 250 | 50/60 | 3 | 1 | 1 | 1 | .02-50 | .10-100 | C2, 5000(1) | 2000 |
| 250 | 50/60 | 1 | 1 | 1 | 1 | .02-50 | .10-100 | C2, 5000(2) | 2000 |
| 250 | 50/60 | 3 | 2 | 1 | 0 | .02-80 | .10-100 | U1, 1000 | 2000 |
| 250 | 50/60 | 3 | 1 | 1 | 0 | .02-60 | .10-100 | U1, 5000 | 2000 |
| 250(5) | 50/60 | 3 | 3 only | 1 | 1 | .02-100 | - | U3, 2000 | - |
| 277 | 50/60 | 1 | 1 | 1 | 1 | .02-50 | - | U2, 2000 | - |
| 277 | 50/60 | 1&3 | 1 | 2 | 1 | .02-50 | - | C2, 5000(1) | - |
| 240/415 | 50/60 | 3 | 2 | 2 | 0 | .02-50 | .10-50 | U2, 2000 | 2000 |
| 240/415 | 50/60 | 1 | 2 | 2 | 0 | .02-50 | .10-50 | C2, 5000(1) | 2000 |
| 277/480 | 50/60 | 3 | 2 | 2 | 1 | .02-30 | - | U2, 2000 | - |
| 277/480 | 50/60 | 3 | 2 | 2 | 1 | .02-50 | - | U2, 1200 | - |
| 277/480 | 50/60 | 3 | 2 | 1 | 1 | .02-30 | - | C2, 5000(3) | - |
| 277/480 | 50/60 | 1&3 | 2 | 1 | 0 | .02-50 | - | C2, 5000(3) | - |
| 480 | 50/60 | 1&3 | 2 | 1 | 1 | .02-30 | - | C2, 5000(3) | - |
| 480 | 50/60 | 3 | 2 | 1 | 0 | .02-50 | - | C2, 5000(3) | - |
| 250 | 400 | 1&3 | 1 | 2 | 1 | .02-50 | - | U2, 1500 | - |

AGENCY APPROVALS - LEL/LELHP

| Voltage | Frequency (Hz) | Phase | Min. Poles | UL/CSA | VDE (amps) | UL489 (AIC) | VDE (AIC) |
|---------|----------------|-------|------------|---------|------------|-------------|-----------|
| 65 | DC | - | 1 | .05-50 | - | 7500 | - |
| 65 | DC | - | 2** | 101-150 | - | 50 000 | - |
| 65 | DC | - | 3** | 175-200 | - | 50000 | - |
| 80 | DC | - | 1 | .05-100 | .10-100 | 10000 | 2000 |
| 80 | DC | - | 1 | .05-100 | - | 50000 | - |
| 80 | DC | - | 2** | 125-150 | 125-150 | 10000 | 2000 |
| 80 | DC | - | 3** | 175-200 | 151-200 | 10000 | 2000 |
| 125 | DC | - | 1 | .05-70 | .05-70 | 5000 | 3000 |
| 125/250 | DC | - | 2 | .05-50 | - | 5000 | - |
| 125 | 50/60 | 1&3 | 1 | .05-40 | - | 10000 | - |
| 125 | 50/60 | 1&3 | 1 | .05-50 | .10-50 | 5000 | 2000 |
| 120/240 | 50/60 | 1 | 2 | .05-70 | .10-50 | 5000 | 2000 |
| 240 | 50/60 | 1&3 | 1 | .05-20 | - | 5000 | - |

AGENCY APPROVALS - CELHP

| | | | | | | | |
|----|----|---|---|-----|---|--------------------|---|
| 80 | DC | - | 4 | 400 | - | 10000 AIC (UL489A) | - |
|----|----|---|---|-----|---|--------------------|---|

AGENCY APPROVALS - CEL/CELP (COMMUNICATIONS)

| Voltage | Frequency (Hz) | Phase | Min. Poles | UL/CSA | VDE (amps) | UL 489A (AIC) | VDE (AIC) |
|---------|----------------|-------|------------|---------|------------|---------------|-----------|
| 65 | DC | - | 1 | .05-50 | - | 7500 | - |
| 65 | DC | - | 2** | 101-150 | - | 50000 | - |
| 80 | DC | - | 1 | .05-100 | - | 50000 | - |
| 80 | DC | - | 2** | 101-200 | - | 10000 | - |
| 80 | DC | - | 3** | 201-250 | - | 10000 | - |
| 125 | DC | - | 1 | .05-70 | - | 5000 | - |
| 80 | DC | - | 1 | 125 | - | 10000 | - |

AGENCY APPROVALS - IDL/IDLP (MARINE)

| Voltage | Frequency (Hz) | Phase | Min. Poles | TC | OL | UL/CSA | VDE (amps) | UL 1077 & CSA (AIC) | VDE (AIC) |
|---------|----------------|-------|------------|----|----|---------|------------|---------------------|-----------|
| 48 | DC | - | 1 | 1 | 1 | .02-100 | - | U1, 5000 | - |
| 48 | DC | - | 2** | 1 | 1 | 101-150 | - | U1, 5000 | - |
| 65 | DC | - | 1 | 1 | 1 | .02-60 | - | U1, 1000 | - |
| 80 | DC | - | 1 | 1 | 1 | .02-100 | - | U2, 1500 | - |
| 125 | 50/60 | 1 | 1 | 1 | 1 | .02-100 | - | U 1, 1500 | - |
| 250 | 50/60 | 1 | 2 | 1 | 1 | .02-100 | - | U2, 1500 | - |
| 250 | 50/60 | 1&3 | 1 | 1 | 1 | .02-60 | - | U1, 1000 | - |

AGENCY APPROVALS - IULQ (TAPPED COIL)

| Voltage | Frequency (Hz) | Phase | Min. Poles | TC | OL | UL/CSA | VDE (amps) | UL 1077 & CSA (AIC) | VDE (AIC) |
|---------|----------------|-------|------------|----|----|-----------|------------|---------------------|-----------|
| 125/250 | 50/60 | 1 | 1 | 1 | 1 | 2/1-30/15 | - | C2, 5000(1) | - |

AGENCY APPROVALS - IULD (DUST SEALED)

| Voltage | Frequency (Hz) | Phase | Min. Poles | TC | OL | UL/CSA | VDE (amps) | UL 1077 & CSA (AIC) | VDE (AIC) |
|---------|----------------|-------|------------|----|----|---------|------------|---------------------|-----------|
| 250 | 50/60 | 1&3 | 1 | 1 | 1 | .02-100 | - | C2, 5000(3) | - |
| 277 | 50/60 | 1 | 1 | 1 | 1 | .02-30 | - | C2, 5000(3) | - |

Notes:

** Paralleled poles; + 2 poles in series; ++ 3 poles in series; (1) With 125 A max. series fuse; (2) Series combination with 209 or 229 series (100 A max.); (3) With 100 A max. series fuse; (4) With blocked vent construction (5) Non-standard construction. "Fit for further use" approval

General notes:

- All supplementary protectors are of the overcurrent (OC) type
 - The family of protectors has been evaluated for end use application for use groups (UG) A, B, C and D
 - The terminals (FW) are suitable for factory wiring only (0)
 - The maximum voltage ratings for which the protectors have been tested are shown in the chart
 - The current is the amperage range that the protectors have been tested
 - The tripping current (TC) for all of the protectors is either either "1" (in the range of 125% to 135% of ampere rating) or "2" (more than 135% of ampere rating)
 - The overload rating (OL) – designates whether the protector has been tested for general use or motor starting applications.
- 0 – tested at 1.5 times amp rating for general use
- 1 – tested at 6 times AC rating or 10 times DC rating for motor starting
- The short circuit current rating (SC) – The short circuit rating in amperes following a letter and number designating the test conditions and any calibration following the short circuit test is defined below:
- C – Indicates short circuit test was conducted with series overcurrent protection
- U – Indicates short circuit test was conducted without series overcurrent protection
- 1 – Indicates a recalibration was not conducted as part of the short circuit testing
- 2 – Indicates a recalibration was performed as part of the short circuit testing
- 3 – Indicates recalibration was performed along with the dielectric and voltage withstand for "Suitable for Further Use" rating

IAL/IUL/IEL DECISION TABLES

The ordering code for IAL/IUL/IEL/LEL circuit protectors may be determined by following the decision steps in the appropriate part number decision table subsequent to this page.

The coding given permits a self-assigning part number but with certain limitations. Special applications may require a factory assigned part number. Typical examples are units with mixed ratings, combinations of styles, or constructions not listed in the third decision table, etc. With these, it is suggested that order entry be by description and/or drawings, and a part number will be established. Additionally, it is standard policy to establish a factory-assigned part number whenever a descriptive drawing exists to provide cross reference, traceability and manufacturing control.

When specifying a circuit breaker for AC motor start or high inrush applications, the peak amplitude and surge duration should be specified for factory assistance in rating selection.

For example the code shown is the code for a single pole breaker with a series construction and auxiliary switch, designed for operation in a 50/60Hz circuit. It has a short time delay, rating of 20 amperes and a marked black handle, and is VDE approved.

To determine the ordering number for your particular IAL/IUL/IEL unit, simply follow the steps shown. You may use this number to place an order or as a reference for further questions you may have.

Notes:
IEL, IELH and IELX circuit protectors are designed to meet 8mm creepage clearance requirements for installation Category 111, Pollution Degree 3, Case A as measured in IEC 664. Intended for use in equipment to comply with IEC 950, 601 and VDE 0804 & 0805.

| 1 First Decision | | |
|------------------------------|---|--|
| Select Type and Terminal | | |
| Type | Description | Terminal |
| IAL **IUL ***IEL | One handle per unit | Standard screw terminal, no designation required |
| IALH **IULH ***IELH | One handle per pole | K Stud terminals |
| | | C Clip terminals |
| | | B Bullet terminals |
| IALN ***IULN | One handle per unit panel seal | |
| IALX **IULX ***IELX | One handle per unit, rocker, bracket mounting | |
| IALZX **IULZX ***IELZX | One handle per unit, rocker, integral mounting | |
| *IDL | One handle per unit UL 1500 | |
| *IDLH | One handle per pole UL 1500 | |
| **IML | One handle per unit mid trip indication | |
| **IMLH | One handle per pole mid trip indication | |
| IALBX **IULBX ***IELBX | One handle per unit, rocker, accidental-off protection | |
| **IMLBX | One handle per unit, mid trip indication, rocker, accidental-off protection | |

*UL Recognized
**UL Recognized, CSA Certified
***UL Recognized, CSA Certified, VDE Approved

| 2 Second Decision | |
|-------------------|-------------|
| Poles | |
| 1 | Single pole |
| 11 | Two pole |
| 111 | Three pole |
| 1111 | Four pole* |

*Not available in toggle seal handle type. Consult factory for 5 and 6 pole IEL part number.

Example:

IEL 1-1REC4-61-20.0-01-V

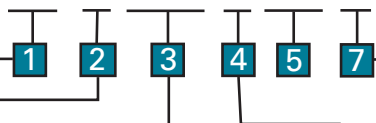

| 3 Third Decision | |
|------------------------|---|
| Internal Configuration | |
| -0 | Switch only (50, 70 or 100 amp switch) |
| -1 | Series |
| -1REC4 | Series with auxiliary switch* .110 quick connect |
| -1REC5 | Series with auxiliary switch* .187 quick connect |
| -1REG4 | Series with auxiliary switch .110 quick connect |
| -1RS4 | Series with alarm switch, electrical trip, .110 quick connect terminals |
| -1RLS4 | Series with alarm switch, electrical trip, .110 quick connect terminals (mid-trip only) |
| -1RS5 | Series with alarm switch, electrical trip, .187 quick connect terminals |
| -3 | Shunt |
| -4 | Relay (not available in IEL/IELX) |

* Only one auxiliary switch is normally supplied on two or three pole units. Switch is located in the right-hand pole (viewed from terminal end) unless otherwise specified.

| 4 Fourth Decision | |
|-------------------|----------------------------|
| Frequency & Delay | |
| SW | Switch only |
| -41 | 400Hz short delay |
| -42 | 400Hz long delay |
| -43 | 400Hz motor start |
| -49 | 400Hz 150% instant trip |
| -51 | DC short delay |
| -52 | DC long delay |
| -53 | DC motor start |
| -59 | DC 125% instant trip |
| -61 | 50/60Hz short delay |
| -62 | 50/60Hz long delay |
| -63 | 50/60Hz motor start |
| -69 | 50/60Hz 125% instant trip |
| -71 | DC/60Hz short delay |
| -72 | DC/60Hz long delay |
| -73 | DC/60Hz motor start |
| -79 | DC/60 Hz 135% instant trip |

For addition of inertial delay, add an iFi to any delay numeral.

V = VDE and CCC Approved

The shaded areas denote VDE and CCC (if applicable) Approval options. This approval requires the addition of a V at the end of the part number. The V will be added to any part number formed entirely from shaded decisions. If non-shaded areas are selected, the unit will not be VDE or CCC Approved, but other approvals still apply.

Note: CCC Approval is pending.

C = CCC Approved

This approval requires the addition of a C at the end of the part number. The unit will not be VDE Approved.

Note: CCC Approval is pending.

5 Fifth Decision

Rated Current

Use three numbers to print required current value between .100 amps minimum and 100 amps maximum.

For example, use: .100 or 2.00 or 10.0

The VDE (Ith) will be 95% of the UL/CSA rated current.

7 Seventh Decision

Handle Color and Marking Selection

IAL, IUL, IEL, IALH, IULH, IELH - Toggle Handle

| Color | Unmarked | Marked* ON-OFF I-O |
|--------|----------|--------------------|
| Black | -00 | -01 (STD) |
| Yellow | -10 | -11 |
| Red | -20 | -21 |
| Blue | -30 | -31 |
| Green | -40 | -41 |
| Orange | -60 | -61 |
| White | -90 | -91 |

Notes:
 1. One or more descriptions may be used as required.
 2. When this is not used, table one may be substituted and U.S. thread and two lockwashers will be supplied. Unit will be rated at 250V (50/60Hz only).
 3. VDE approved at 250Vac
 4. VDE approved at 415Vac

6 Sixth Decision

Optional

| | |
|----|---|
| | Standard hardware. No designation required. |
| -A | Metric thread mounting inserts and terminals |
| -B | Barrier |
| -C | 277V (50/60Hz only) (See note 3) |
| -D | 240/415V (50/60Hz only) |
| -E | 277V/480V (50/60Hz only) (See note 4) |
| -G | Handle guard, (available in ZX, BX and snap-in versions only) |
| -K | 1/4 - 20 stud (M6 stud when -A option is selected) (<=70A requires -K, if >70A do not use -K) |
| -L | Handle lock |
| -M | Handle in opposite pole |
| -P | Snap-in face plate adapter |
| -U | 120/240V 50/60Hz |
| -W | Wire clamp supplied (VDE approved up to and including 16.0 amps) |
| -X | Handle guard with no actuation feature (BX rocker only) |
| -1 | Silver 5/16" (.312") bullet |
| -2 | Gold 5/16" (.312") bullet |

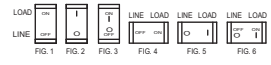
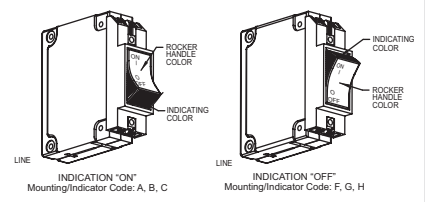

MARKING DETAIL "A" (SEE TABLE)

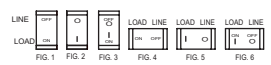
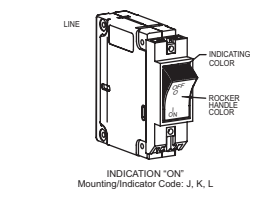

MARKING DETAIL "B" (SEE TABLE)

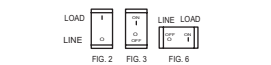
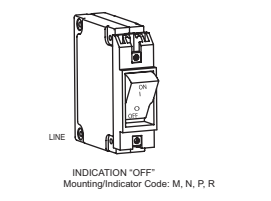

MARKING DETAIL "C" (SEE TABLE)

7 Seventh Decision

Rocker Handle Color, Indicator Color and Marking Selection (See Notes)

IALX, IULX, IELX, IALZX, IULZX, IELZX Rocker Handle (Single Rocker Color)

| Rocker Handle Color | Indicating Color | Marking Color | Indicates: | Unmarked | Vertical Mounting | | | Horizontal Mounting | | | Marking Detail |
|---------------------|------------------|---------------|------------|----------|-------------------|-----------|------------------|---------------------|-----------|------------------|----------------|
| | | | | | On-Off Fig.1 | I-O Fig.2 | On-Off I-O Fig.3 | On-Off Fig.4 | I-O Fig.5 | On-Off I-O Fig.6 | |
| Black | N/A | White | N/A | -00 | -01 | -02 | -03 | -04 | -05 | -06 | A |
| Red | N/A | White | N/A | -20 | -21 | -22 | -23 | -24 | -25 | -26 | |
| Grey | N/A | Black | N/A | -40 | -41 | -42 | -43 | -44 | -45 | -46 | |
| Orange | N/A | Black | N/A | -50 | -51 | -52 | -53 | -54 | -55 | -56 | |
| White | N/A | Black | N/A | -90 | -91 | -92 | -93 | -94 | -95 | -96 | |

IALZX, IULZX, IELZX Rocker Handle (Dual Rocker Color)

| | | | | | | | | | | | |
|-------|-------|-------|-----|-----|-----|-----|-----|-----|-----|-----|---|
| Black | White | White | On | -A0 | -A1 | -A2 | -A3 | -A4 | -A5 | -A6 | A |
| Black | Red | White | On | -B0 | -B1 | -B2 | -B3 | -B4 | -B5 | -B6 | |
| Black | Green | White | On | -C0 | -C1 | -C2 | -C3 | -C4 | -C5 | -C6 | |
| Black | White | White | Off | -F0 | -F1 | -F2 | -F3 | -F4 | -F5 | -F6 | |
| Black | Red | White | Off | -G0 | -G1 | -G2 | -G3 | -G4 | -G5 | -G6 | |
| Black | Green | White | Off | -H0 | -H1 | -H2 | -H3 | -H4 | -H5 | -H6 | |

IALBX, IULBX, IELBX, LELBX Rocker Handle (Dual Rocker Color)

| | | | | | | | | | | | |
|-------|--------|--------|-----|-----|-----|-----|-----|-----|-----|-----|---|
| Black | White | White | Off | -M0 | N/A | -M2 | -M3 | N/A | N/A | -M6 | C |
| Black | Red | Red | Off | -N0 | N/A | -N2 | -N3 | N/A | N/A | -N6 | |
| Black | Green | Green | Off | -P0 | N/A | -P2 | -P3 | N/A | N/A | -P6 | |
| Black | Yellow | Yellow | Off | -R0 | N/A | -R2 | -R3 | N/A | N/A | -R6 | |

Notes: A. Bezels of IALBX, IULBX, IELB, IELBX are black.
 B. Consult factory for other marking options.

LEL DECISION TABLES

1 First Decision

Select Type and Terminal

| Type | Description | Terminal |
|-------|--|--|
| LEL | One handle per unit | Standard screw terminal, no designation required |
| LELH | One handle per pole | |
| LML | One handle per unit, mid-trip indication | K Stud terminals |
| LMLH | One handle per pole, mid-trip indication | C Clip terminals |
| LELZX | One handle per unit, rocker, integral mounting | B Bullet terminals |
| LMLZX | One handle per unit, rocker, mid-trip indication, integral mounting | |
| LELZX | One handle per unit, rocker, integral mounting | |
| LELBX | One handle per unit, rocker, accidental-off protected | |
| LMLBX | One handle per unit, rocker, mid-trip indication, accidental-off protected | |

Note: Other options available, consult factory.

5 Fifth Decision

Rated Current

Use three numbers to print (.050 or 1.50 or 100) Value between **.050** amps and **100** amps.

6 Sixth Decision

Optional

| | |
|----|---|
| -A | Metric thread mounting inserts and terminals |
| -B | Barrier |
| -F | 240V 50/60Hz |
| -G | Handle guard, (available in ZX, BX and snap-in versions only) |
| -K | 1/4 - 20 Stud (M6 Stud when -A option is selected) (50A requires -K, >50A do not use -K) |
| -L | Handle Lock |
| -M | Handle in opposite pole |
| -P | Snap-in mounting plate adapter |
| -U | 120/240Vac, 5000 A.I.C., 70A max. 2 pole only with barrier (VDE 250Vac) |
| -V | 125VDC |
| -X | Handle guard with no actuate "off" feature (see detail C) |
| -1 | Silver 5/16" (.312") bullet |
| -2 | Gold 5/16" (.312") bullet |

Notes:
1. One or more descriptions may be used as required.
2. When this decision is not used, decision 7 may be substituted and U.S. thread will be supplied.
3. If (M5 or M6) studs are required, use "A" only on an LELK.

2 Second Decision

Poles

| | |
|-----|-------------|
| 1 | Single pole |
| 11 | Two pole |
| 111 | Three pole |

4 Fourth Decision

Frequency and Delay

| | |
|------|---------------------------|
| -51 | DC short delay |
| -52 | DC long delay |
| -53* | DC motor start |
| -59 | DC 125% instant trip |
| -61 | 50/60Hz short delay |
| -62 | 50/60Hz long delay |
| -63 | 50/60Hz motor start |
| -69 | 50/60Hz 125% instant trip |

For addition of inertial delay, add an "F" to any delay numeral.
*Not available above 100 amps.

7 Seventh Decision

LEL Toggle Handle Color Selection

| | |
|-----|--------------------------|
| -01 | Black w/ white markings |
| -11 | Yellow w/ black markings |
| -21 | Red w/ white markings |
| -31 | Blue w/ white markings |
| -41 | Green w/ white markings |
| -61 | Orange w/ black markings |
| -91 | White w/ black markings |

See alternate 7th Decision for ZX and BX Rocker Handles.

Example:

LEL 1 - 1REC4 - 61 - 20.0 - 01 - V

1 2 3 4 5 7

3 Third Decision

Internal Configuration

| | |
|--------|---|
| -1 | Series |
| -1REC4 | Series with auxiliary switch .110 quick connect |
| -1REC5 | Series with auxiliary switch .187 quick connect |
| -1REG4 | Series with auxiliary switch (gold contacts) .110 quick connect |
| -1RS4 | Series with alarm switch, electrical trip, .110 quick connect |
| -1RLS4 | Series with alarm switch, electrical trip, .110 quick connect* |

* Used only with mid-trip.

V = VDE and CCC Approved

The shaded areas denote VDE and CCC (if applicable) Approval options. This approval requires the addition of a V at the end of the part number. The V will be added to any part number formed entirely from shaded decisions. If non-shaded areas are selected, the unit will not be VDE or CCC Approved, but other approvals still apply.

C = CCC Approved

The approval requires the addition of a C at the end of the part number. The unit will not be VDE Approved.

Notes: The LEL family of circuit breakers are designed to meet 8mm creepage and clearance requirements for installation Category 111, pollution degree 3, Case A as measured in IEC 664. Intended for use in equipment designed to comply with IEC 380, 435, 601 AND VDE 0730, 0804 & 0805.

7 Seventh Decision

Rocker Handle Color, Indicator Color and Marking Selection (See Notes)

LELZX & LMLZX Rocker Handle (Single Rocker Color)

| Rocker Handle Color | Indicating Color | Marking Color | Indicates: | Unmarked | Vertical Mounting | | | Horizontal Mounting | | | Marking Detail |
|---------------------|------------------|---------------|------------|----------|-------------------|-----------|------------------|---------------------|-----------|------------------|----------------|
| | | | | | On-Off Fig.1 | I-O Fig.2 | On-Off I-O Fig.3 | On-Off Fig.4 | I-O Fig.5 | On-Off I-O Fig.6 | |
| Black | N/A | White | N/A | -00 | -01 | -02 | -03 | -04 | -05 | -06 | A |
| Red | N/A | White | N/A | -20 | -21 | -22 | -23 | -24 | -25 | -26 | |
| Grey | N/A | Black | N/A | -40 | -41 | -42 | -43 | -44 | -45 | -46 | |
| Orange | N/A | Black | N/A | -50 | -51 | -52 | -53 | -54 | -55 | -56 | |
| White | N/A | Black | N/A | -90 | -91 | -92 | -93 | -94 | -95 | -96 | |

LELZX & LMLZX Rocker Handle (Dual Rocker Color)

| | | | | | | | | | | | |
|-------|-------|-------|-----|-----|-----|-----|-----|-----|-----|-----|---|
| Black | White | White | On | -A0 | -A1 | -A2 | -A3 | -A4 | -A5 | -A6 | A |
| Black | Red | White | On | -B0 | -B1 | -B2 | -B3 | -B4 | -B5 | -B6 | |
| Black | Green | White | On | -C0 | -C1 | -C2 | -C3 | -C4 | -C5 | -C6 | |
| Black | White | White | Off | -F0 | -F1 | -F2 | -F3 | -F4 | -F5 | -F6 | |
| Black | Red | White | Off | -G0 | -G1 | -G2 | -G3 | -G4 | -G5 | -G6 | |
| Black | Green | White | Off | -H0 | -H1 | -H2 | -H3 | -H4 | -H5 | -H6 | |

| | | | | | | | | | | | |
|-------|-------|-------|----|-----|-----|-----|-----|-----|-----|-----|---|
| Black | White | White | On | -J0 | -J1 | -J2 | -J3 | -J4 | -J5 | -J6 | B |
| Black | Red | White | On | -K0 | -K1 | -K2 | -K3 | -K4 | -K5 | -K6 | |
| Black | Green | White | On | -L0 | -L1 | -L2 | -L3 | -L4 | -L5 | -L6 | |

LELBX Rocker Handle (Dual Rocker Color)

| | | | | | | | | | | | |
|-------|--------|--------|-----|-----|-----|-----|-----|-----|-----|-----|---|
| Black | White | White | Off | -M0 | N/A | -M2 | -M3 | N/A | -M5 | -M6 | C |
| Black | Red | Red | Off | -N0 | N/A | -N2 | -N3 | N/A | -N5 | -N6 | |
| Black | Green | Green | Off | -P0 | N/A | -P2 | -P3 | N/A | -P5 | -P6 | |
| Black | Yellow | Yellow | Off | -R0 | N/A | -R2 | -R3 | N/A | -R5 | -R6 | |

Notes: A. Bezels of IALBX, IULBX, IELB, IELBX are black.
B. Consult factory for other marking options.

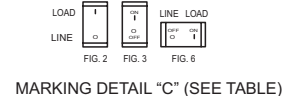
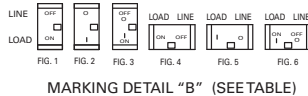
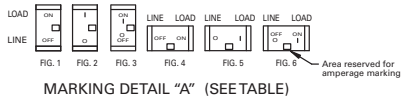
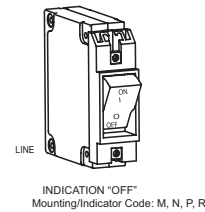
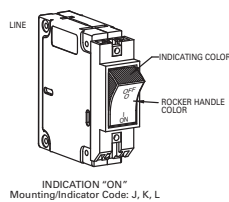
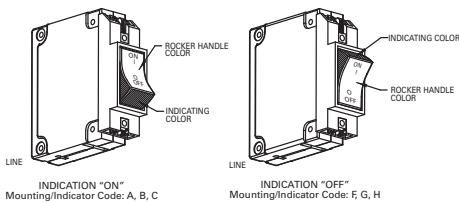

CEL DECISION TABLES

1 First Decision

Select Type and Terminal

| Type | Description | Terminal |
|-------|---|--|
| CEL | One handle per unit, UL489A Listed | Standard screw terminal, no designation required |
| CELH | One handle per pole, UL489A Listed | K Stud terminals |
| CML | Single pole only, one handle per unit mid-trip construction, UL489A Listed | C Clip terminals |
| CMLH | One handle per pole mid-trip construction, UL489A Listed | B Bullet terminals |
| CELZX | One handle per unit, rocker handle, UL489A Listed | |
| CMLZX | Single pole only, one handle per unit, rocker handle w/ RLS aux switch, mid-trip construction, UL489A Listed | |
| CELBX | One handle per unit, flat rocker handle, UL489A Listed | |
| CMLBX | Single pole only, one handle per unit, flat rocker handle w/ RLS aux switch, mid-trip construction, UL489A Listed | |

5 Fifth Decision

Rated Current

Use three numbers in build (.050 or 1.50 or 100).
Required value between .050 amps minimum and 125 amps maximum.

6 Sixth Decision

Optional

| | |
|----|--|
| -A | Metric thread mounting inserts and terminals |
| -B | Barrier |
| -G | Snap-in mounting plate adapter with handle guard (ZX, BX and snap-in only) |
| -K | 1/4-20 Stud (M6 stud when metric option -A selected) 50A requires -K, >50A do not use -K |
| -P | Snap-in mounting plate adapter |
| -T | 80VDC, 10000AIC, (required over 50A) |
| -V | 125VDC |
| -1 | Silver 5/16" (.312") bullet |
| -2 | Gold 5/16" (.312") bullet |

Notes:
1. One or more descriptions may be used as required.
2. When this decision is not used, decision 7 may be substituted and U.S. thread will be supplied.

7 Seventh Decision

LEL Toggle Handle Color Selection

| | |
|-----|--------------------------|
| -01 | Black w/ white markings |
| -11 | Yellow w/ black markings |
| -21 | Red w/ white markings |
| -31 | Blue w/ white markings |
| -41 | Green w/ white markings |
| -61 | Orange w/ black markings |
| -91 | White w/ black markings |

See alternate 7th Decision for ZX and BX Rocker Handles.

2 Second Decision

Poles

| | |
|-----|-------------|
| 1 | Single pole |
| 11 | Two pole |
| 111 | Three pole |

3 Third Decision

Internal Configuration

| | |
|-----------|--|
| -1 | Series |
| -1REC4 | Series with auxiliary switch .110 quick connect |
| -1RLS4 ** | Series with auxiliary switch .110 quick connect, mid-trip only |
| -1REC5 | Series with auxiliary switch .187 quick connect |
| -1RS4 ** | Alarm switch, .110 quick connect |

* Only one auxiliary switch is normally supplied on two and three pole units switch is located in the right hand pole (viewed from terminal end). Note, aux switch followed by "R" indicates reverse mount option
** Not available for 125 amp single pole

4 Fourth Decision

Frequency and Delay

| | |
|------|----------------------|
| -51 | DC short delay |
| -52 | DC long delay |
| -53* | DC motor start |
| -59 | DC 125% instant trip |

For addition of inertial delay, add an "F" to any delay numeral. Example: -51F
*Not available above 100 amps.

V = VDE and CCC Approved

The shaded areas denote VDE and CCC (if applicable) approval options. This approval requires the addition of a V at the end of the part number. The V will be added to any part number formed entirely from shaded decisions. If non-shaded areas are selected, the unit will not be VDE or CCC Approved, but other approvals still apply.

C = CCC Approved

The approval requires the addition of a C at the end of the part number. The unit will not be VDE Approved.

T = TÜV Approved

The approval requires the addition of a T at the end of the part number. The unit will only be TÜV EN60947-2 approved with a single pole, 125 amp rating configuration.

Example:

CEL 1 - 1REC4 - 51 - 20.0 - A - 01 - V

1 2 3 4 5 6 7

7 Seventh Decision

Rocker Handle Color, Indicator Color and Marking Selection (See Notes)

| LELZX & LMLZX Rocker Handle (Single Rocker Color) | | | | | | | | | | | |
|---|------------------|---------------|------------|----------|-------------------|-----------|------------------|---------------------|-----------|------------------|----------------|
| Rocker Handle Color | Indicating Color | Marking Color | Indicates: | Unmarked | Vertical Mounting | | | Horizontal Mounting | | | Marking Detail |
| | | | | | On-Off Fig.1 | I-O Fig.2 | On-Off I-O Fig.3 | On-Off Fig.4 | I-O Fig.5 | On-Off I-O Fig.6 | |
| Black | N/A | White | N/A | -00 | -01 | -02 | -03 | -04 | -05 | -06 | A |
| Red | N/A | White | N/A | -20 | -21 | -22 | -23 | -24 | -25 | -26 | |
| Grey | N/A | Black | N/A | -40 | -41 | -42 | -43 | -44 | -45 | -46 | |
| Orange | N/A | Black | N/A | -50 | -51 | -52 | -53 | -54 | -55 | -56 | |
| White | N/A | Black | N/A | -90 | -91 | -92 | -93 | -94 | -95 | -96 | |
| LELZX & LMLZX Rocker Handle (Dual Rocker Color) | | | | | | | | | | | |
| Black | White | White | On | -A0 | -A1 | -A2 | -A3 | -A4 | -A5 | -A6 | A |
| Black | Red | White | On | -B0 | -B1 | -B2 | -B3 | -B4 | -B5 | -B6 | |
| Black | Green | White | On | -C0 | -C1 | -C2 | -C3 | -C4 | -C5 | -C6 | |
| Black | White | White | Off | -F0 | -F1 | -F2 | -F3 | -F4 | -F5 | -F6 | |
| Black | Red | White | Off | -G0 | -G1 | -G2 | -G3 | -G4 | -G5 | -G6 | |
| Black | Green | White | Off | -H0 | -H1 | -H2 | -H3 | -H4 | -H5 | -H6 | |
| Black | White | White | On | -J0 | -J1 | -J2 | -J3 | -J4 | -J5 | -J6 | B |
| Black | Red | White | On | -K0 | -K1 | -K2 | -K3 | -K4 | -K5 | -K6 | |
| Black | Green | White | On | -L0 | -L1 | -L2 | -L3 | -L4 | -L5 | -L6 | |
| LELZX Rocker Handle (Dual Rocker Color) | | | | | | | | | | | |
| Black | White | White | Off | -M0 | N/A | -M2 | -M3 | N/A | -M5 | -M6 | C |
| Black | Red | Red | Off | -N0 | N/A | -N2 | -N3 | N/A | -N5 | -N6 | |
| Black | Green | Green | Off | -P0 | N/A | -P2 | -P3 | N/A | -P5 | -P6 | |
| Black | Yellow | Yellow | Off | -R0 | N/A | -R2 | -R3 | N/A | -R5 | -R6 | |

Notes: A. Bezels of IALBX, IULBX, IELB, IELBX are black.
 B. Consult factory for other marking options.

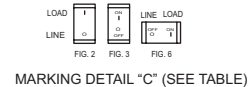
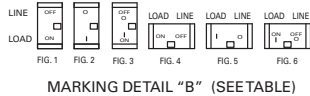
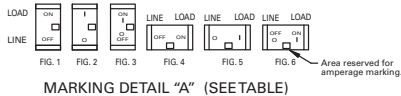
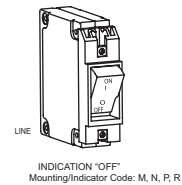
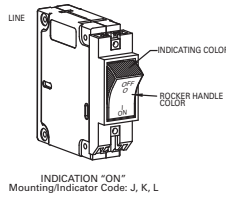
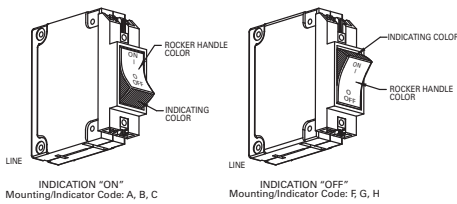

LELHP DECISION TABLES

| 1 First Decision | |
|---------------------------------|---|
| Select Type with Stud Terminals | |
| LELPK | One handle per unit |
| LMLPK | One handle per unit, mid-trip |
| LELZXPk | One ZX rocker handle per unit (integral mounting) |
| LMLZXPk | One ZX rocker handle per unit, mid-trip (integral mounting) |
| LELBXPk | One BX rocker handle per unit (integral mounting) |
| LMLBXPk | One BX rocker handle per unit, mid-trip (integral mounting) |
| LELHPK | One handle per pole |
| LMLHPK | One handle per pole, mid-trip |

1. One toggle handle per unit on 125A to 150A units (2-parallel pole)
2. 175A to 200A (3-parallel pole) requires handle in each pole, "H" selection

| 2 Second Decision | |
|-------------------|------------------------------|
| Poles | |
| 11 | Two pole (up to 150 amps) |
| 111 | Three pole (160 to 200 amps) |

| 3 Third Decision | |
|------------------------|--|
| Internal Configuration | |
| -1 | Series |
| -1REC4 | Series with auxiliary switch .110 quick connect |
| -1REG4 | Series, aux switch (gold contacts) .110 quick connect |
| -1RLS4 | Series with alarm aux switch .110 quick connect, mid-trip only |
| -1RLSG4 | Series, alarm aux switch (gold contacts), .110 quick connect, mid-trip only |
| -1RS4 | Series with alarm aux switch .110 quick connect |
| -1REC5 | Series with aux switch .187 quick connect |
| -1RLS5 | Series with alarm aux switch .187 quick connect, mid-trip only |
| -1RS4 | Series with alarm aux switch .187 quick connect |
| -1RS5 | Series with alarm aux switch .187 quick connect, mid-trip |

| 4 Fourth Decision | |
|---------------------|---------------------------------------|
| Frequency and Delay | |
| -51 | DC 125% short delay (125 to 150 amp) |
| | DC 135% short delay (160 to 200 amp) |
| -52 | DC 125% long delay (125 to 150 amp) |
| | DC 135% long delay (160 to 200 amp) |
| -59 | DC 125% instant trip (125 to 150 amp) |
| | DC 135% instant trip (160 to 200 amp) |

For addition of inertial delay, add an "F" to any delay option. Example: -59 becomes -59F

| 5 Fifth Decision | |
|----------------------|------|
| Rated Current (Amps) | |
| | 125. |
| | 130. |
| | 135. |
| | 150. |
| | 175. |
| | 200. |

Additional ratings available.

| 6 Sixth Decision | |
|--|--|
| Optional (leave entry blank if none apply) | |
| -A | Metric thread mounting inserts and terminals |
| -G | Snap-in mounting plate adapter with handle guard (ZX, BX & snap-in only) |
| -X | Handle guard with no actuate off feature (BX only, no mid-trip) |
| -P | Snap-in mounting plate adapter |

Notes:
1. One or more descriptions may be used as required.
2. When this decision is not used, decision 7 may be substituted and U.S. thread will be supplied.

V = VDE Approved

The shaded areas denote VDE approval options. This approval requires the addition of a V at the end of the part number. The V will be added to any part number formed entirely from shaded decisions. If non-shaded areas are selected, the unit will not be VDE approved, but other approvals still apply.

Example:

LELHPK 11 - 1REC4 - 51 - 125. - A - 01 - V

1 2 3 4 5 6 7

| 7 Seventh Decision | |
|---------------------|--------------------------|
| Toggle Handle Color | |
| -01 | Black w/ white markings |
| -11 | Yellow w/ black markings |
| -21 | Red w/ white markings |
| -31 | Blue w/ white markings |
| -41 | Green w/ white markings |
| -61 | Orange w/ black markings |
| -91 | White w/ black markings |

See LEL alternative 7th decision for ZX & BX rocker handles

CELHP DECISION TABLES

| 1 First Decision | | Terminal | |
|------------------|---|----------|--|
| Select Type | | | |
| CELP | One toggle handle per unit | | Standard screw terminal, no designation required |
| CELHP | One toggle handle per pole | K | Stud terminals |
| CMLHP | One toggle handle per pole, mid-trip construction | C | Clip terminals |
| CELZXP | One rocker handle per unit | B | Bullet terminals |
| CELBXP | One flat rocker handle per unit | | |

1. One toggle handle per unit is available only on 101A to 200A (two parallel pole construction)
 2. 201A to 250A (three parallel pole constructions) require handles in each pole, "H" version first decision
 3. Unit supplied with bullet terminals will not have buss bar installed, unless requested, buss bar supplied standard to 150A only.
 4. One handle per unit is available for 100A to 200A (two parallel pole constructions) and 201A to 250A (three pole constructions) (ZX & BX versions only)
 5. 400 amps available with toggle handles only

V = VDE Approved

The shaded areas denote VDE approval options. This approval requires the addition of a V at the end of the part number. The V will be added to any part number formed entirely from shaded decisions. If non-shaded areas are selected, the unit will not be VDE approved, but other approvals still apply.

Example:

CELHPK 11 - 1REC4 - 51 - 125. - A - 01 - V

1 2 3 4 5 6 7

| 2 Second Decision | |
|-------------------|------------------------------|
| Poles | |
| 11 | Two pole (up to 150 amps) |
| 111 | Three pole (160 to 250 amps) |
| 1111 | Four pole (400 amps) |

| 3 Third Decision | |
|------------------------|---|
| Internal Configuration | |
| -0 | Switch only |
| -1 | Series |
| -1REC4 | Series with auxiliary switch .110 quick connect |
| -1RLS4 * | Series with alarm aux. switch .110 quick connect, mid-trip only |
| -1RS4 * | Series with alarm aux. switch .110 quick connect |
| -1REC5 | Series with auxiliary switch .187 quick connect |
| -1RLS5 * | Series with alarm aux. switch .187 quick connect, mid-trip only |
| -1RS4 * | Series with alarm aux. switch .187 quick connect |

1. Only one auxiliary switch is normally supplied on two and three pole units. Switch is located in the right hand pole (viewed from terminal end panel mount position).
 2. When more than one aux. switch is required, change the 1 (of the 1REC4) to 2 or 3. If switches are mixed, then use "2R" or 3R"
 * Not available at 400 amps

| 4 Fourth Decision | |
|---------------------|---------------------------------------|
| Frequency and Delay | |
| -51 | DC 125% short delay (101 to 150 amp) |
| | DC 135% short delay (160 to 250 amp) |
| -52 | DC 125% long delay (101 to 150 amp) |
| | DC 135% long delay (160 to 250 amp) |
| -53 | DC 125% motor start (101 to 150 amp) |
| | DC 135% motor start (160 to 250 amp) |
| -59 | DC 125% instant trip (101 to 150 amp) |
| | DC 135% instant trip (160 to 250 amp) |

| 5 Fifth Decision | |
|-------------------------------|------|
| Rated Current (Amps) | |
| | 125. |
| | 130. |
| | 135. |
| | 150. |
| | 175. |
| | 200. |
| | 400. |
| Additional ratings available. | |

| 7 Seventh Decision | |
|---|--------------------------|
| Toggle Handle Color | |
| -01 | Black w/ white markings |
| -11 | Yellow w/ black markings |
| -21 | Red w/ white markings |
| -31 | Blue w/ white markings |
| -41 | Green w/ white markings |
| -61 | Orange w/ black markings |
| -91 | White w/ black markings |
| See LEL alternative 7th decision for ZX & BX rocker handles | |

| 6 Sixth Decision | |
|--|--|
| Optional (leave entry blank if none apply) | |
| -A | Metric thread mounting inserts and terminals |
| -B | Barrier |
| -G | Snap-in mounting plate adapter with handle guard (ZX, BX & snap-in only) |
| -X | Handle guard with no actuate off feature (BX only, no mid-trip) |
| -1 | Silver 5/16" (.312") bullet |
| -2 | Gold 5/16" (.312") bullet |

Notes:
 1. One or more descriptions may be used as required.
 2. When this decision is not used, decision 7 may be substituted and U.S. thread will be supplied

AIRPAX®

IELR Series Rail-Mount Magnetic Circuit Protectors



| | | |
|----------------------------------|---|------------|
| <i>Introduction</i> | • | 175 |
| <i>Poles</i> | • | 176 |
| <i>Specifications</i> | • | 177 |
| <i>Operating Characteristics</i> | • | 178 |
| <i>Delay Curves</i> | • | 179 |
| <i>Approvals</i> | • | 183 |
| <i>Decision Tables</i> | • | 184 |





AIRPAX® | IELR Series

Rail-Mount Hydraulic Magnetic Circuit Protectors

INTRODUCTION

Designed specifically for the 35mm symmetrical DIN rail, Airpax IALHR, IULHR and IELHR series Rail-Mount Magnetic circuit protectors offer the advantages of quick and easy mounting or removal which results in efficient and economical wiring, while conserving space.

These circuit protectors are available in 1, 2, 3 and 4 pole models, with a choice of handle colors with on/off and international I/O markings. These protectors comply with UL and CSA standards and meet IEC and VDE spacing requirements. Typical applications include computers and

peripherals, telecommunications, medical equipment, machine tools and process control instrumentation. They provide the reliable performance associated with magnetic circuit protection.

Mounting - These circuit protectors are designed to mount on standard 35mm DIN rails, such as 35x7.5 or 35x15 per DIN EN50022. Other specialty rails are available from suppliers that provide a means of mounting non DIN mount components by means of special captive jam nuts.

Single Pole

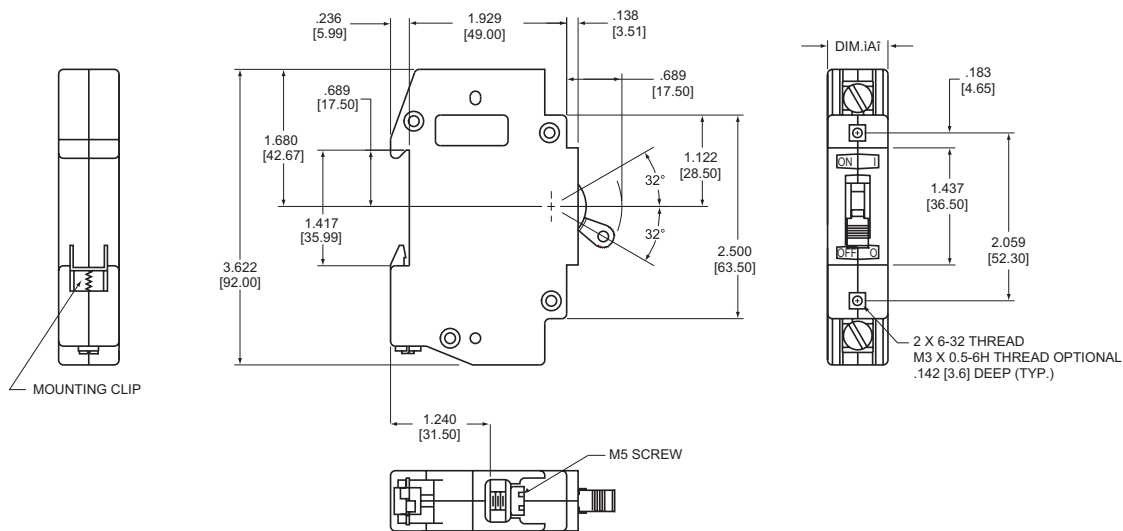

Two Pole

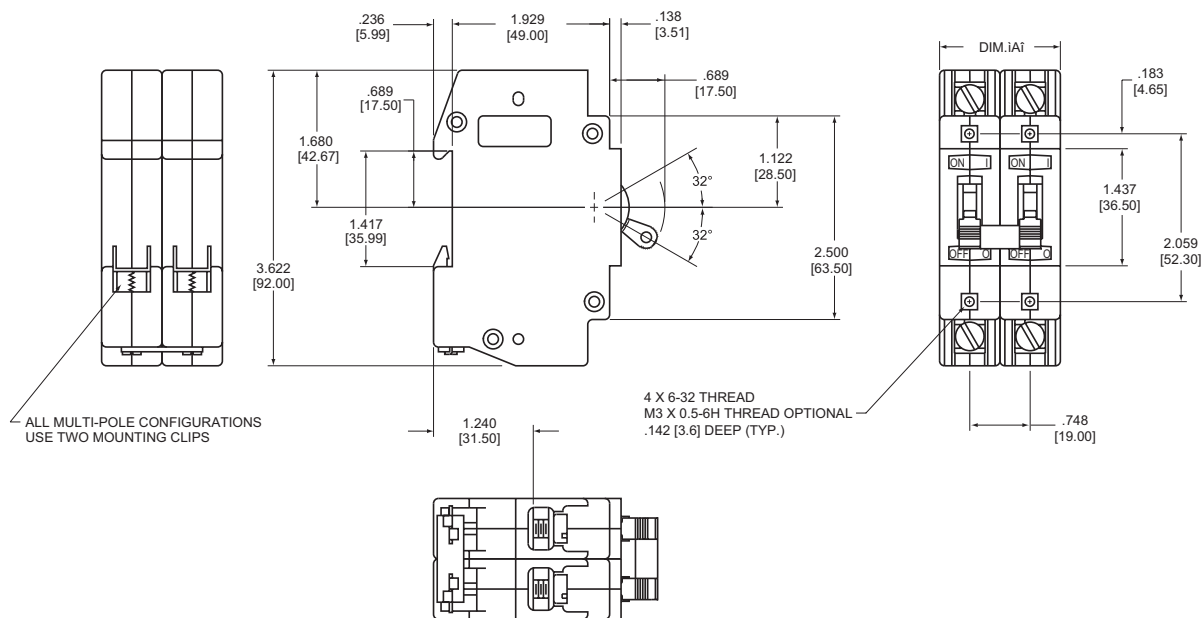

Note: Tolerance $\pm .015$ [38] unless noted.
Dimensions in brackets [] are millimeters.

MULTI-POLE DIMENSIONS - DIM "A"

| | |
|--------|-------------------------------------|
| 1 pole | .750 \pm .02 [19.05 \pm .5] max |
| 2 pole | 1.515 [38.48] max |
| 3 pole | 2.265 [57.53] max |
| 4 pole | 3.015 [76.58] max |

Note: Dimension "A" varies with # of poles

IELR SPECIFICATIONS

Series Trip

The most popular configuration for magnetic protectors is the series trip where the sensing coil and contacts are in series with the load being protected. The handle position conveniently indicates circuit status. In addition to providing conventional overcurrent protection, it's simultaneously used as an on-off switch.

Switch Only

In the event that over-current protection is not desired, the coil mechanism can be deleted, providing an excellent low cost, single or multi-pole power switch.

Insulation Resistance

100 megohm minimum at 500Vdc between all electrically isolated terminals.

Dielectric Strength

3750Vac (3750V~) shall withstand AC voltages 50/60Hz for 60 seconds between all electrically isolated terminals.

Endurance

Circuit breakers shall operate a minimum of 10,000 operations; 6,000 with rated current and voltage and 4,000 with no load.

Operating Temperature

-40°C to +85°C.

IEC 144 Classification

Type handle spacings-IP40. Terminals-IP00.

Moisture Resistance

10 days, 95 percent relative humidity at 40°C in accordance with IEC68-2-3, test C.

Salt Spray

Five percent solution at 35°C in accordance with IEC68-2-11, test K, 48 hours.

Shock

50g, 11m sec, half sine with rated current, except no current with handle down. Instantaneous units use 80 percent rated current. Test in accordance with IEC68-2-27, test E_a. This assumes that adequate end stops are used to prevent longitudinal movement of the circuit protector.

Vibration

4g, 5-500Hz (maximum double amplitude displacement 1.5mm) with rated current except no current with handle down. Instantaneous units use 80 percent rated current, in accordance with IEC68-2-6, test F, method A, one hour per plane. This assumes that adequate end stops will be used to prevent longitudinal movement of the circuit protector.

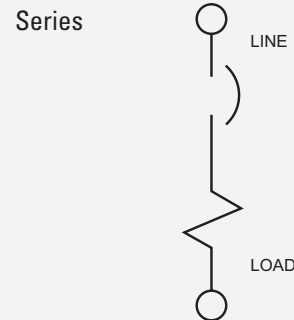

Three Pole Schematic Diagram

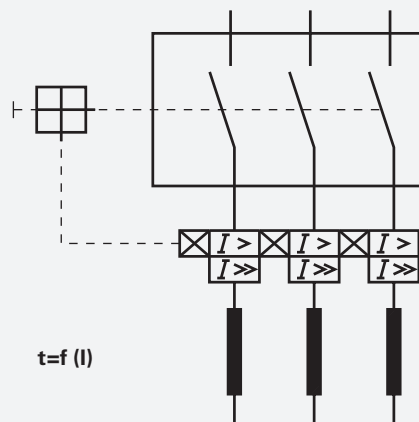

IELR OPERATING CHARACTERISTICS

| APL/UPL - NOMINAL DCR / IMPEDANCE | | | |
|-----------------------------------|-----------------------|-----------------------|-----------------------|
| Current Ratings (Amps) | Resistance (ohms) | Impedance (ohms) | Impedance (ohms) |
| | DC Delays | AC, 50/60Hz Delays | AC, 400Hz Delays |
| | 51, 52, 53, 59 | 61, 62, 63, 69 | 41, 42, 43, 49 |
| 0.20 | 45.8 | 28.5 | 71.94 |
| 1.0 | 1.38 | 1.10 | 2.85 |
| 5.0 | .371 | .29 | .76 |
| 10.0 | .055 | .051 | .12 |
| 15.0 | .017 | .016 | .032 |
| 20.0 | .006 | .006 | .010 |
| 30.0 | .003 | .004 | .006 |
| 50.0 | .0019 | .0018 | .0019 |
| 60.0 | .00157 | .00134 | — |
| 70.0 | .00147 | .00133 | — |

Notes: DCR and impedance based on 100% rated current applied and stabilized for a minimum of one hour. Tolerance .05-2.5 amperes ± 20%; 2.6-20 amperes ± 25%; 21-70 amperes ± 50%. Consult factory for special values and for coil impedance of delays not shown.

Inrush Pulse Tolerance

Pulse tolerance is defined as a single pulse of half sine wave 50/60Hz peak current amplitude of 8 milliseconds duration that will not trip the circuit breaker.

| PULSE TOLERANCES | |
|---------------------------------|----------------------------------|
| Delay | Pulse Tolerance |
| 61, 62, 63 (.1 to 70 amps) | 12 times (approx.) rated current |
| 61F, 62F, 63F (.1 to 25 amps) | 20 times (approx.) rated current |
| 61F, 62F, 63F (25.1 to 70 amps) | 18 times (approx.) rated current |

| PERCENTAGE OF RATED CURRENT VS TRIP TIME IN SECONDS AT +25°C | | | | | | | | |
|--|---------|---------------|-----------|------------|------------|-------------|-------------|-------------|
| Delay | 100% | 125% (Note A) | 150% | 200% | 400% | 600% | 800% | 1000% |
| 41 | No Trip | May trip | .5 to 8 | .15 to 1.9 | .02 to 4 | .006 to .25 | .004 to .1 | .004 to .05 |
| 42 | No Trip | May trip | 5 to 70 | 2.2 to 25 | .40 to 5 | .012 to 2 | .006 to .2 | .006 to .15 |
| 43 | No Trip | May trip | 35 to 350 | 12 to 120 | 1.5 to 20 | .012 to 2.2 | .01 to .22 | .01 to .1 |
| 49 | No Trip | May trip | .100 max. | .050 max. | .020 max. | .020 max. | .020 max. | .020 max. |
| 51 | No Trip | .5 to 6.5 | .3 to 3 | .1 to 1.2 | .031 to .5 | .011 to .25 | .004 to .1 | .004 to .08 |
| 52 | No Trip | 2 to 60 | 1.8 to 30 | 1 to 10 | .15 to 2 | .04 to 1 | .008 to .5 | .006 to .1 |
| 53 | No Trip | 80 to 700 | 40 to 400 | 15 to 150 | 2 to 20 | .015 to 9 | .015 to .55 | .012 to .2 |
| 59 | No Trip | .120 max. | .100 max. | .050 max. | .022 max. | .017 max. | .017 max. | .017 max. |
| 61 | No Trip | .7 to 12 | .35 to 7 | .130 to 3 | .030 to 1 | .015 to .3 | .01 to .15 | .008 to .1 |
| 62 | No Trip | 10 to 120 | 6 to 60 | 2 to 20 | .2 to 3 | .02 to 2 | .015 to .8 | .01 to .25 |
| 63 | No Trip | 50 to 700 | 30 to 400 | 10 to 150 | 1.5 to 20 | .4 to 10 | .013 to .85 | .013 to .5 |
| 69 | No Trip | .120 max. | .100 max. | .050 max. | .022 max. | .017 max. | .017 max. | .017 max. |
| 71 | No Trip | .44 to 10 | .3 to 7 | .1 to 3 | .03 to 1 | .012 to .3 | .004 to .15 | .004 to .1 |
| 72 | No Trip | 1.8 to 100 | 1.7 to 60 | 1 to 20 | .15 to 3 | .015 to 2 | .008 to .79 | .006 to .28 |
| 73 | No Trip | 50 to 600 | 30 to 400 | 10 to 150 | 1.8 to 20 | .015 to 10 | .015 to .88 | .011 to .5 |
| 79 | No Trip | .120 max. | .100 max. | .050 max. | .023 max. | .016 max. | .015 max. | .015 max. |

*Notes: All trip times and trip currents are specified with the protector mounted in the normal vertical position at ambient temperature of 25 C. Protectors do not carry current prior to application of overload.
A: 135% for delays 71, 72, 73 and 79.*

IELR DELAY CURVES

400Hz, DC, 50/60Hz Delay Curves (typ)

A choice of delays is offered for DC, 50/60Hz, 400Hz, or combined DC/50/60Hz applications. Delays 49, 59, 69 and 79 provide fast acting, instantaneous tripping and are often used to protect sensitive electronic equipment (not recommended where a known inrush exists). Delays 41, 51, 61 and 71 have a short delay for general purpose applications. Delays 42, 52, 62 and 72 are long enough for most transformers and capacitor loads. Delays 43, 53, 63 and 73 are extra long for special motor applications.

50/60Hz Delay Curves (typ)

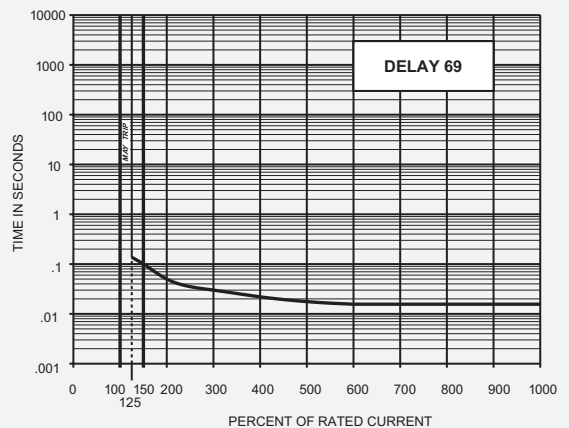
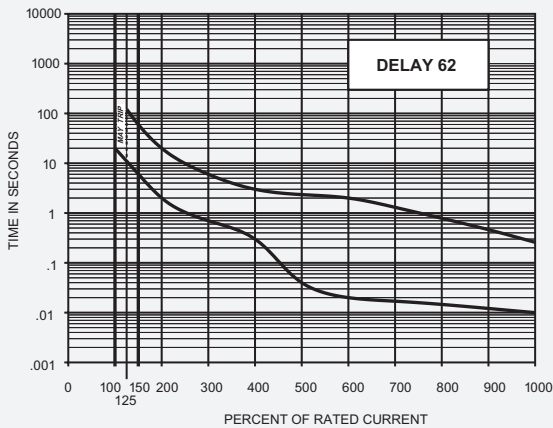
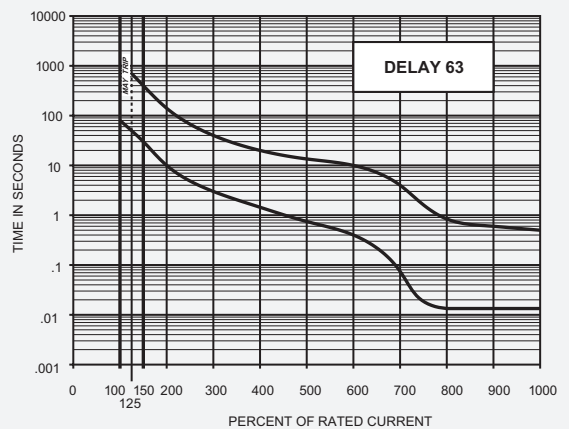
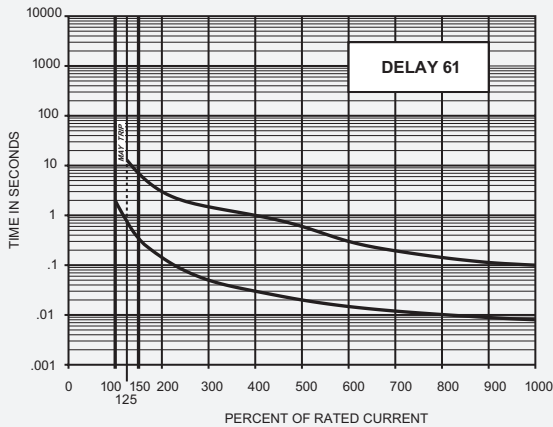

DC Delay Curves (typ)

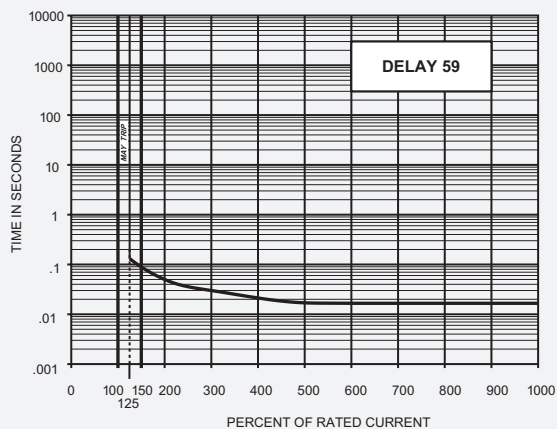
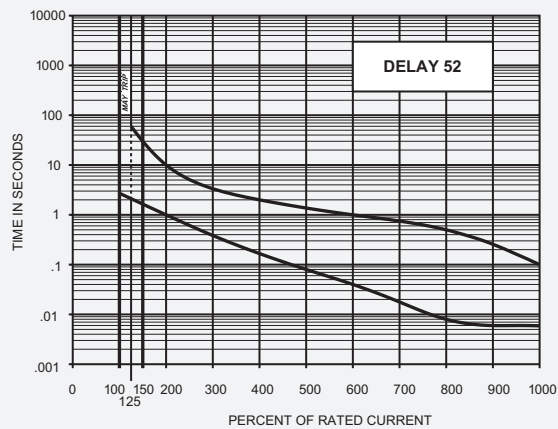
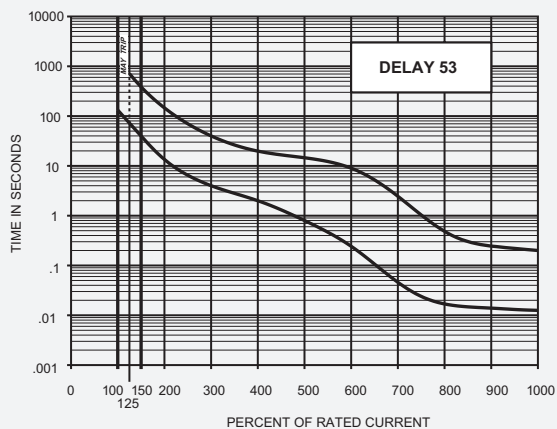
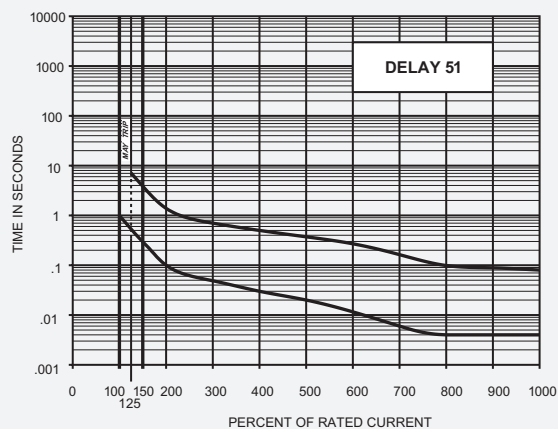

**DC/50/60Hz Delay Curves (typ)
(Multi-Frequency)**

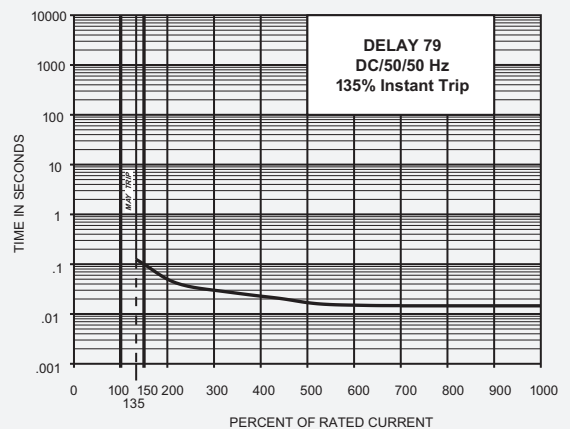
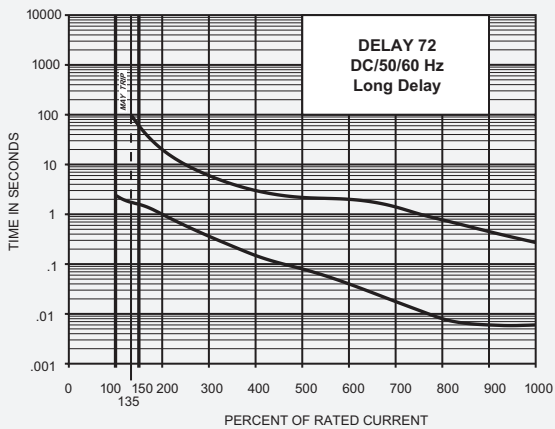
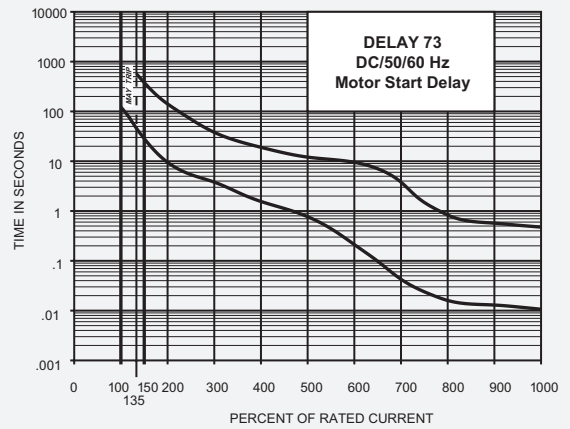
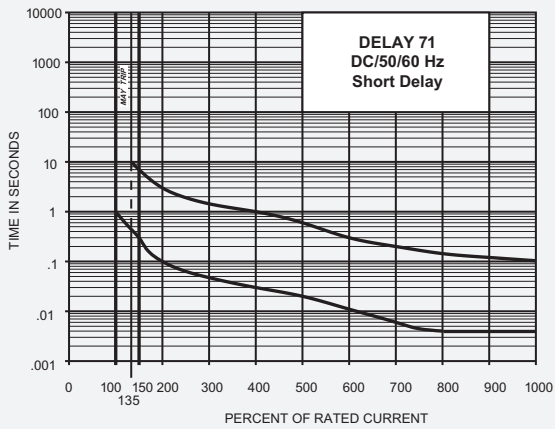

400Hz Delay Curves (typ)

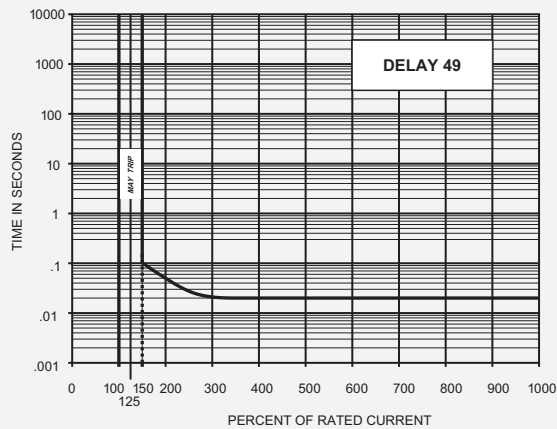
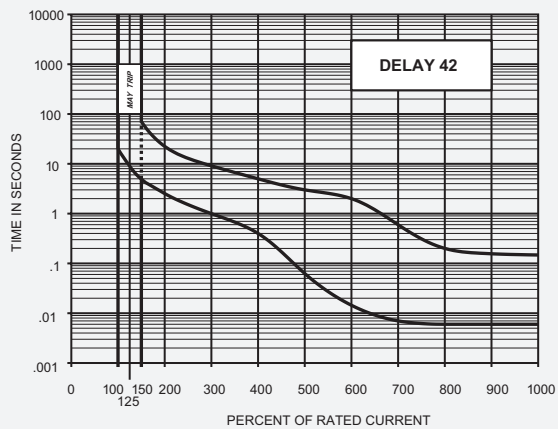
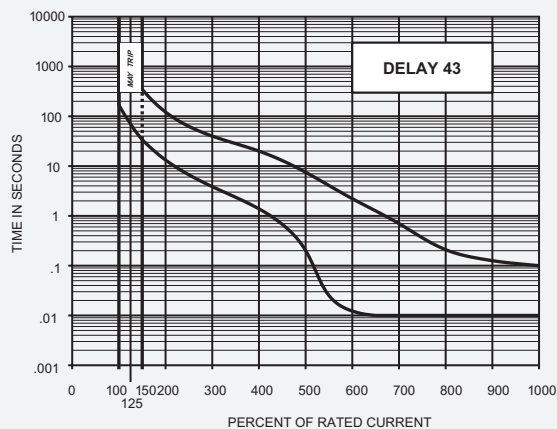
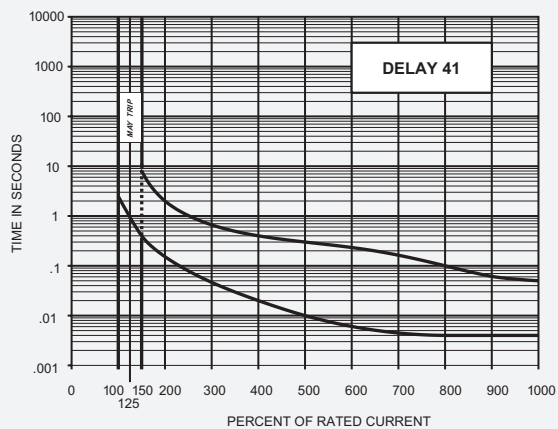

AGENCY APPROVALS

| Voltage (Volts) | | | | Rated Current (Amps) | | Interrupting Capacity, Amps | |
|-----------------|----------------|-------|-----------|----------------------|----------|-----------------------------|------|
| Max Voltage | Frequency (Hz) | Phase | Min Poles | UL/CSA | VDE | UL1077 & CSA | VDE |
| 80 | DC | — | 1 | .05 to 50 | .10 - 50 | u2, 1000 | 4000 |
| 80 | DC | — | 1 | .05 to 100 | — | u2, 5000 | — |
| 250 | 50/60 | 1 & 3 | 1 | .05 to 50 | .10 - 50 | 3500 | 2000 |
| 250 | 50/60 | 1 & 3 | 1 | .05 to 70 | — | 2000 | — |
| 250 | 50/60 | 1 & 3 | 1 | .05 to 50 | — | 5000 (1) | — |
| 250 | 50/60 | 1 & 3 | 1 | .05 to 70 | — | 5000 (1) | — |
| 277 | 50/60 | 1 | 1 | .05 to 50 | — | 2000 | — |
| 277 | 50/60 | 1 | 1 | .05 to 50 | — | 5000 (1) | — |
| 240/415 | 50/60 | 1 & 3 | 2 | .05 to 50 | .10 - 30 | 2000 | 2000 |
| 240/415 | 50/60 | 1 & 3 | 2 | .05 to 50 | — | 5000 (1) | — |
| 277/480 | 50/60 | 3 | 2 | .05 to 30 | — | 2000 | — |
| 250 | 400 | 1 & 3 | 1 | .05 to 50 | — | 1750 | — |

Note: (1) with 125A max series fuse.

IELR DECISION TABLES

How to Order

The ordering code for IELR circuit protectors may be determined by following the steps in the decision tables shown here.

The coding given permits a self-assigning part number, but with limitations. Using the illustrated coding system, it will automatically be assumed that all poles are identical. When all poles of a multi-pole protector are not identical, please contact an Airpax sales representative or the factory for a part number. One great virtue of magnetic circuit protectors is their adaptability to complex circuits. Thus, variations from pole to pole can become the rule rather than the exception. Descriptive drawings are recommended to avoid confusion.

When specifying a protector for AC motor start or high inrush applications, it is helpful to know the peak amplitude and surge duration for proper protector selection.

Notes:

When poles are not identical, each pole is to be described and a special Airpax number will be assigned.

Thomas & Betts (T&B) Narrow Tongue Lug P/N 54108NT is recommended for units rated above 50A. The T&B lug or an equivalent must be used on units rated 70A and above.

1 First Decision

| Type | |
|--------------|--|
| IALHR | One handle per pole (multi-pole only) |
| IULHR | One handle per pole (multi-pole only) UL Recognized, CSA Certified and VDE Approved ratings |
| IELHR | One handle per pole (multi-pole only) UL Recognized, CSA Certified and VDE Approved ratings |
| IALR | One handle per unit |
| IULR | One handle per unit UL Recognized and CSA Certified ratings |
| IELR | One handle per unit UL Recognized, CSA Certified and VDE Approved ratings |
| IMLR | Mid-trip indication, One handle per unit |
| IMLHR | Mid-trip indication, One handle per pole |

2 Second Decision

| Poles | |
|-------------|-------------|
| 1 | Single pole |
| 11 | Two pole |
| 111 | Three pole |
| 1111 | Four pole |

3 Third Decision

| Configuration | |
|---------------|---------------------------------|
| -0 | Switch only (Omit 4th decision) |
| -1 | Series |

V = VDE Approved

The shaded areas denote VDE Approval options. This approval requires the addition of a V at the end of the part number. The V will be added to any part number formed entirely from shaded decisions. If non-shaded areas are selected, the unit will not be VDE approved, but other approvals still apply.

Example:

IELR 1 - 1 - 61 - 20.0 - 01 - V

1 2 3 4 5 7

4 Fourth Decision

| Frequency & Delay | |
|-------------------|-------------------------------|
| SW | Switch Only |
| -41 | 400Hz short delay |
| -42 | 400Hz long delay |
| -43 | 400Hz motor start |
| -49 | 400Hz 150% instant trip |
| -51 | DC short delay |
| -52 | DC long delay |
| -53 | DC motor start |
| -59 | DC 125% instant trip |
| -61 | 50/60Hz short delay |
| -62 | 50/60Hz long delay |
| -63 | 50/60Hz motor start |
| -69 | 50/60Hz 125% instant trip |
| -71 | DC/50/60 Hz short delay |
| -72 | DC/50/60 Hz long delay |
| -73 | DC/50/60 Hz motor start |
| -79 | DC/50/60 Hz 135% instant trip |

For addition of inertial delay, add an "F" to any delay numeral.

5 Fifth Decision

| Rated Current | |
|---|-------------|
| Standard ratings listed. For other ratings, please contact the factory. | |
| .100 | 10.0 |
| .250 | 15.0 |
| .500 | 20.0 |
| .750 | 30.0 |
| 1.0 | 35.0 |
| 2.5 | 40.0 |
| 5.0 | 50.0 |
| 7.5 | 60.0 |
| | 70.0 |

Use three numbers to print required value between .050 amperes minimum and 70.0 amperes maximum.

6 Sixth Decision

| Optional | |
|-----------|--|
| | Standard hardware. No designation necessary. |
| -A | Metric thread mounting inserts |
| -C | 277V (50/60Hz only) |
| -D | 240/415V (50/60Hz only) |

7 Seventh Decision

| Handle Color Selection | |
|-------------------------------------|----------------------------|
| Unmarked | |
| -00 | Black |
| -10 | Yellow |
| -20 | Red |
| -30 | Blue |
| -40 | Green |
| -60 | Orange |
| -90 | White |
| Marked (Combination On - Off / I-O) | |
| -01 | Black with white markings |
| -11 | Yellow with black markings |
| -21 | Red with white markings |
| -31 | Blue with white markings |
| -41 | Green with white markings |
| -61 | Orange with black markings |
| -91 (Std.) | White with black markings |

AIRPAX®

209 Series Magnetic Circuit Protectors



| | | |
|----------------------------------|---|------------|
| <i>Introduction</i> | • | 187 |
| <i>249 Power Selector System</i> | • | 189 |
| <i>Multi-Pole</i> | • | 191 |
| <i>Configurations</i> | • | 193 |
| <i>Operating Characteristics</i> | • | 195 |
| <i>Delay Curves</i> | • | 196 |
| <i>Specifications</i> | • | 199 |
| <i>Decision Tables</i> | • | 201 |

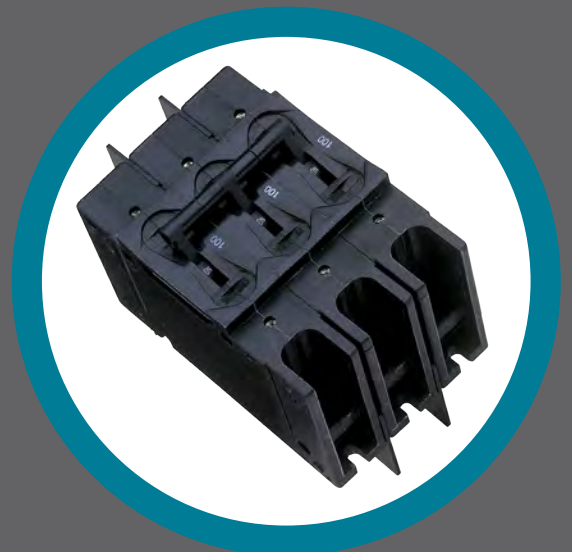

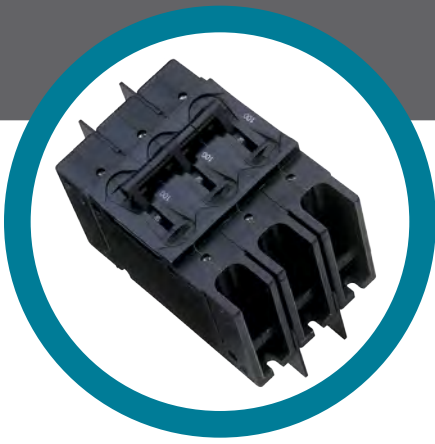

AIRPAX® | 209/219/229/249/279 Series Hydraulic Magnetic Circuit Protectors

INTRODUCTION

The 209, E-Frame circuit breaker combines power switching with accurate, reliable circuit protection in a compact single or multi-pole unit. The unit is ideal for branch circuit applications such as EDP, air conditioners, panel boards and lighting controls.

The 209 is actually a family of circuit breakers available in one through six pole assemblies with a variety of configurations and terminal styles to meet your application needs. First in this family is the 209, a general purpose E-Frame circuit breaker which complies with UL Standard 489. Other members of the family include the 219, for manual controller applications, which complies to UL Standard 508, the 229, for supplementary protectors applications, which complies to UL Standard 1077, and the 299, a Special Construction version.

Utilizing the hydraulic-magnetic principle, the 209 family adapts itself to local applications and environments. Temperature conditions, which affect fuses and other thermal devices, are not a concern. The magnetic /ampere turn principle minimizes nuisance tripping due to temperature variations.

Inrush currents, due to ferroresonant transformers, lamps and capacitive filters, are now becoming more significant. Recognizing the need for this type of protection, Airpax offers the unique inertial delay which is standard for all 50/60Hz time delay units, but may be deleted where inrush is not a problem. No extra cost or special order is required.

The 209 family of circuit breakers withstands high pulses without tripping or affecting normal delay curves. This performance, however, does not derate or sacrifice protection.

209/219/229 MAGNETIC CIRCUIT PROTECTORS

Terminal Style

209 E-Frame circuit breakers may be specified with either screw terminals, stud or solderless connectors.

A choice of front or back connected terminal styles is available. The back connected terminal style is available with stud terminals only. Front terminal style is available with either screw terminals or solderless connectors.

Refer to Sixth Decision Table for front connected terminal information.

Barriers for back connected terminal styles are supplied on multi-pole units only. Line and load connections may be made to either terminal and terminals will be identified as shown.

| DIMENSION "A" | |
|-----------------|-----------------------------|
| Number of Poles | Dimensions "A" |
| 1 | 1.026 ± .010 [26.06 ± 3.30] |
| 2 | 2.072 [52.63] Max |
| 3 | 3.108 [78.94] Max |
| 4 | 4.144 [105.26] Max |
| 5 | 5.180 [131.57] Max |
| 6 | 6.216 [157.89] Max |

Front Connected Solderless Connector (Back Mounted)

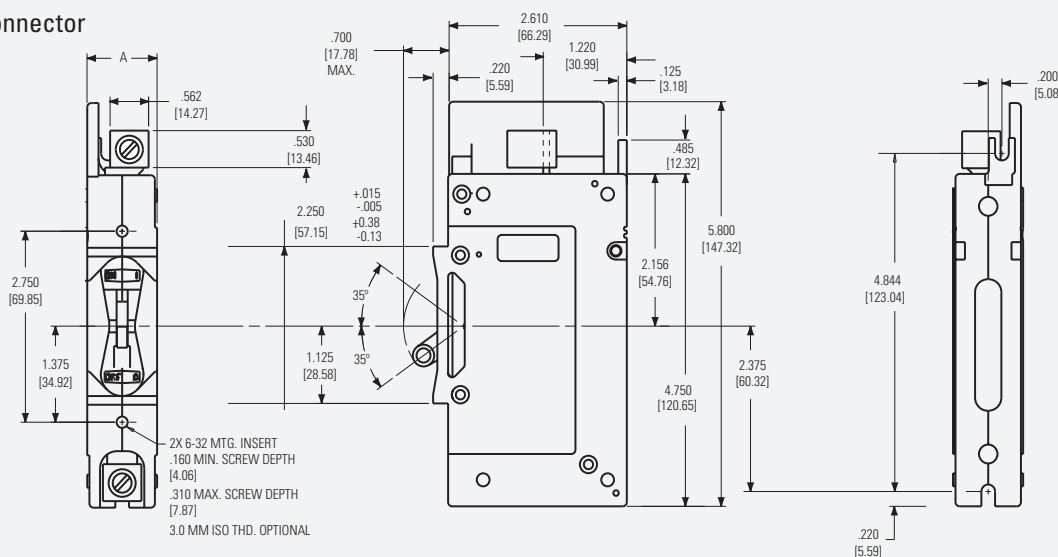

Back Connected Stud Terminal (Front Mounted)

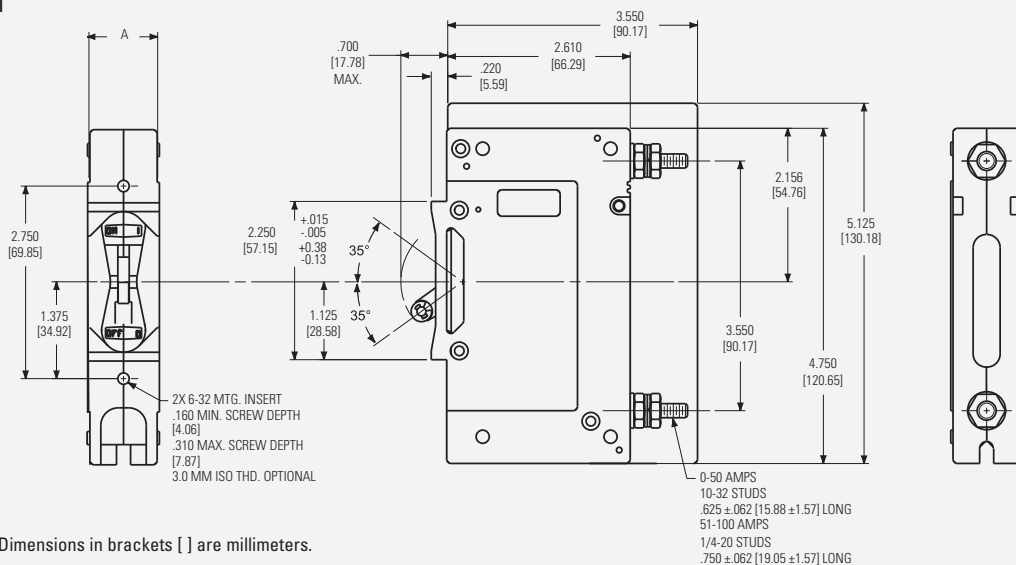

Note: Tolerance ± .015 [.38] unless noted. Dimensions in brackets [] are millimeters.

249 POWER SELECTOR BREAKER SYSTEM

The 249 Power Selector Breaker System combines magnetic-hydraulic branch circuit overload protection and a power system selector switch in one device.

The 249 is designed to allow selection of any one of two, three or four independent power systems. This is accomplished with fool-proof sliding-gate handle covers. The number of sliding covers is one less than the number of power systems. With this arrangement, it is impossible to switch "ON" more than one power system at a time.

Since the 249 Power Selector Breaker System is listed as a Branch Circuit Breaker per UL 489 and power switching is accomplished by UL listed breakers, it is usually not necessary to include additional branch service protection.

Standard options available include terminals for front or back connections, choice of trip time delay, current ratings to 100 amperes and single or multi-pole sections.

Trip Time Delay

Three inverse time delays are available to permit close coordination with various loads. Delays 51 and 61 are short delays for electronic loads. Delays 52 and 62 are medium delays for mixed loads. Delays 53 and 63 are long delays for motor loads.

Current and Voltage Ratings

Single pole and multi-pole breaker ratings are available up to 100 amperes, 240Vac or 125Vdc. The special configuration for Marine use has a 120V/240Vac rating for current rating up to 100 amperes.

Master Drawing

Standard circuit breaker terminal and configurations are shown. For other types, consult factory.

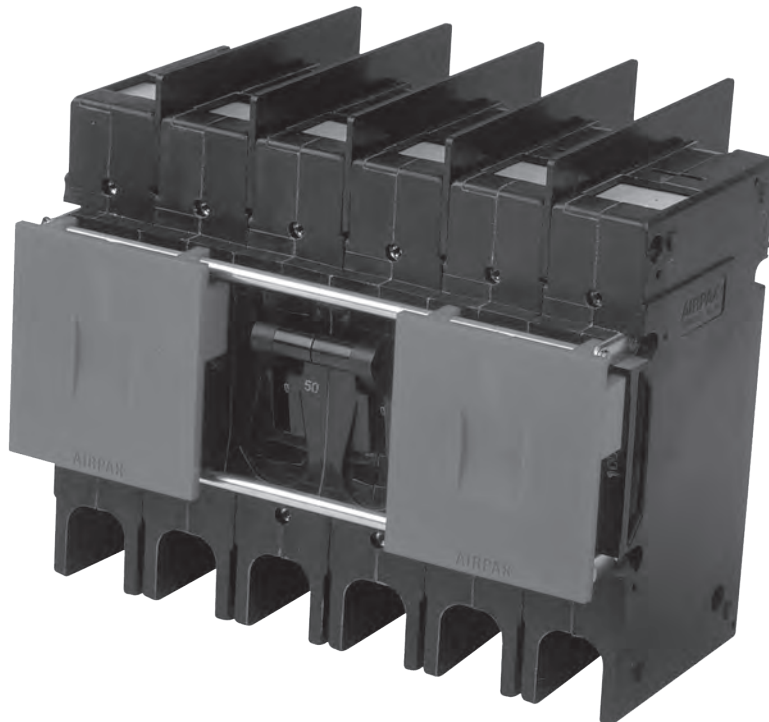

249 Master Drawing

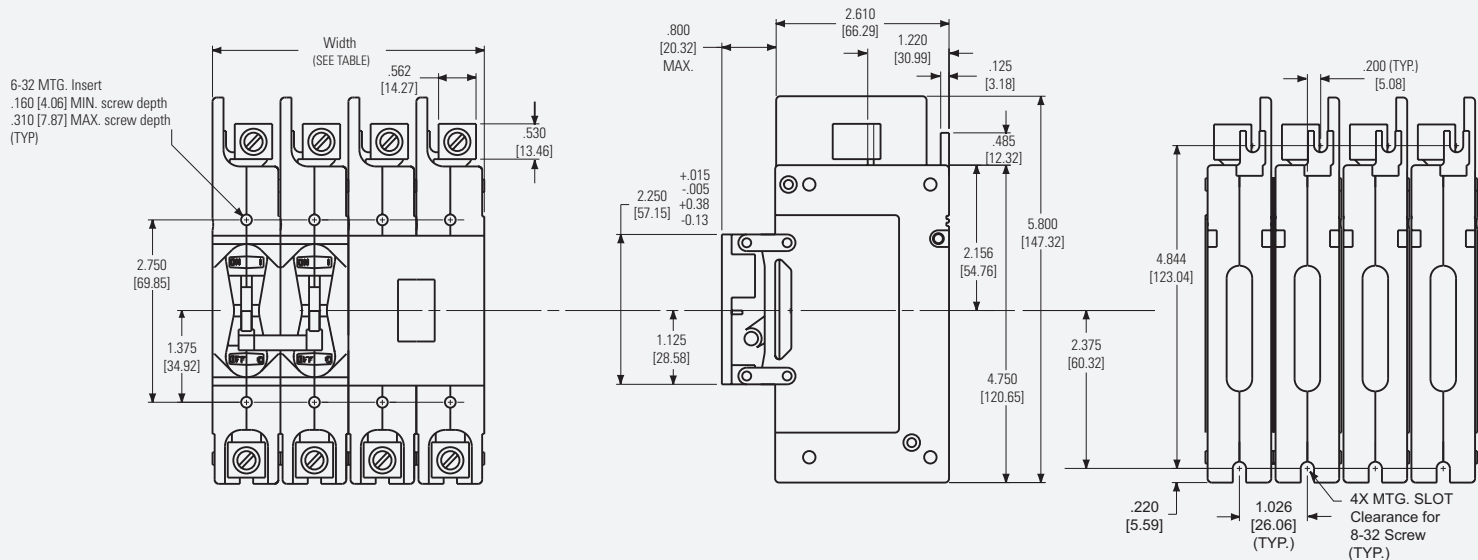

1/4 - 20 Studs

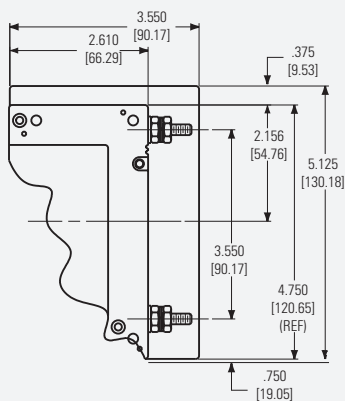

10 - 32 or 1/4 - 20 Screw Terminals

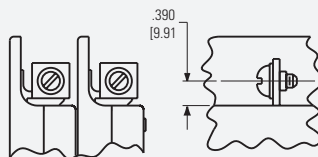

Note: Tolerance $\pm .015$ [.38] unless noted. Dimensions in brackets [] are millimeters.

| DIMENSIONS | |
|-----------------|--------------------|
| Number of Poles | Width |
| 9 | 9.324 [236.83] Max |
| 8 | 8.288 [210.52] Max |
| 6 | 6.216 [157.89] Max |
| 4 | 4.144 [105.26] Max |
| 2 | 2.072 [52.63] Max |

209/219/229 MULTI-POLE CIRCUIT PROTECTORS

Common-Trip Construction

All multi-pole protectors contain an internal trip bar which opens all poles in the event of an overload in any pole. Handles are ganged externally for simultaneous actuation.

Individual poles may differ in ratings, delays and configurations, providing an almost limitless number of combinations.

Multi-pole protectors (up to 6 poles) easily satisfy special modern day circuitry. Series, shunt, relay and auxiliary switch construction add to the versatility of design engineering. Airpax's sales engineering force is ready to assist in proper unit selection, both for equipment protection and economical design.

Three Phase, Four Pole Includes Control Protector

Remote shutdown of equipment is sometimes necessary or desirable in today's sophisticated equipment. The 219 four pole assembly fills this need for three phase operation. Three of the four poles are designed for the circuit's proper operating current and over-current protection. The fourth pole may be designed for instantaneous tripping by logic circuitry, interlocks or from a manual remote site or control. The control power required would be quite low, with voltages from 5 to 125Vdc, or 5 to 240Vac available. The fourth pole construction is optional. It may be either series, shunt or relay, depending on the application required. When specifying, both the minimum trip voltage and Hz are required. Factory consultation is readily available.

Front Connected Solderless Connector (Back Mounted)

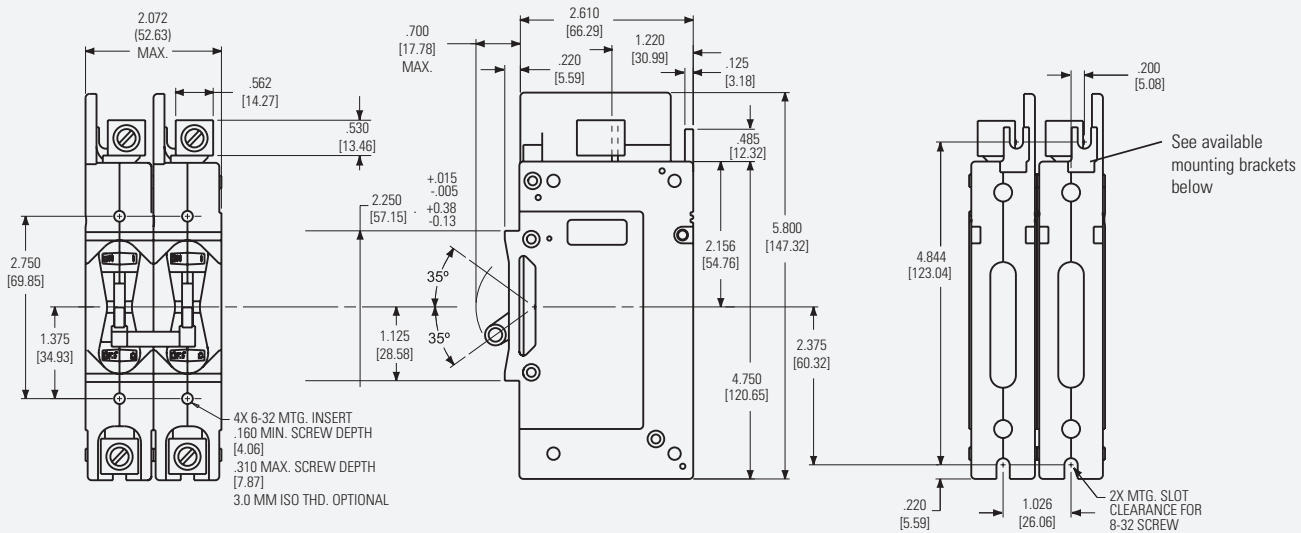

10 - 32 or 1/4 - 20 Screw Terminals

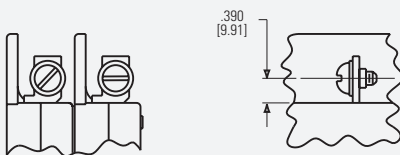

Slotted Mounting Bracket terminal codes -2, -3, -5, -7, -3M, -5M, -7M

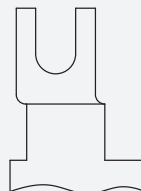

SCALE: 3/1

Short Mounting Bracket terminal codes -2C, -3C, -5C, -7C

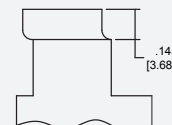

SCALE: 3/1

**Back Connected Stud Terminal
(Front Mounted)**

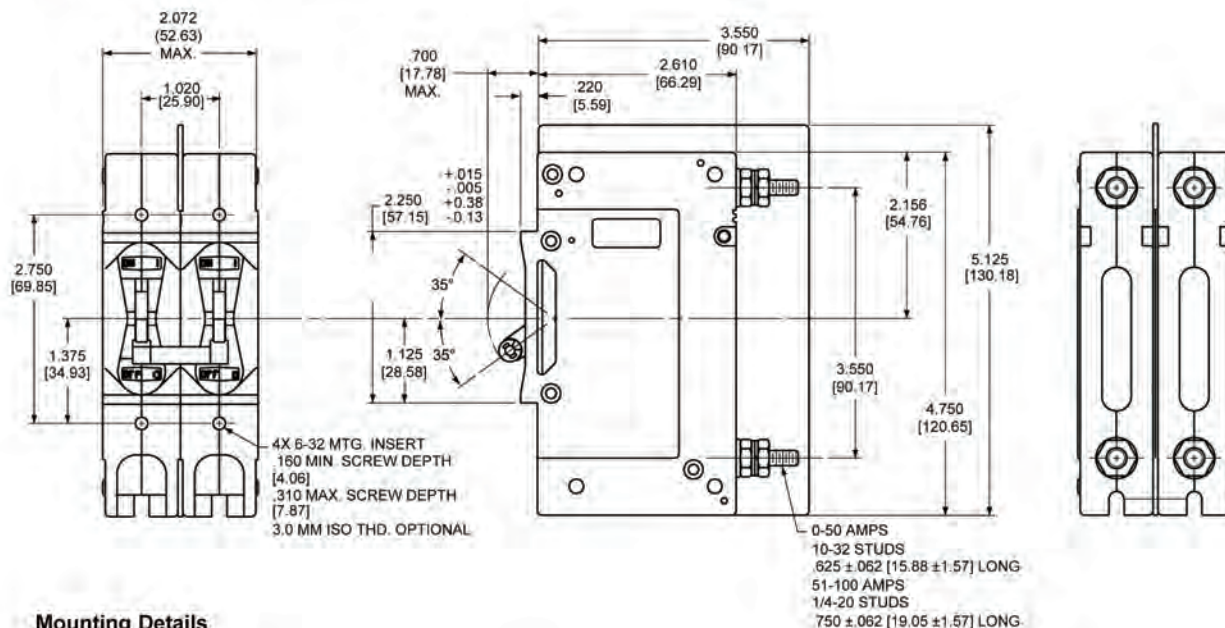

Mounting Details

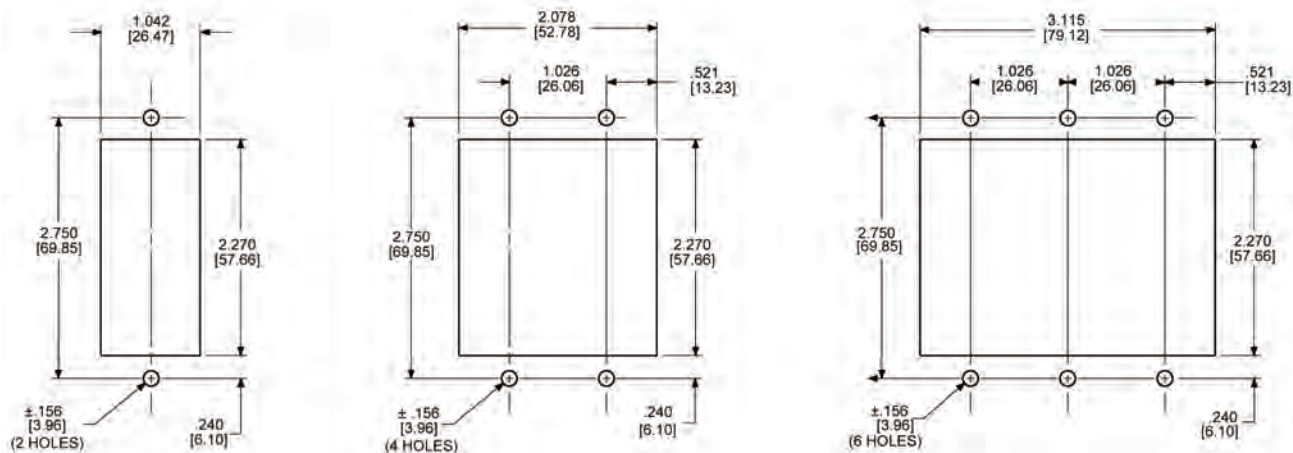

| DIMENSIONS | |
|-----------------|-----------------------------|
| Number of Poles | Width |
| 1 | 1.026 ± .010 [26.06 ± .254] |
| 2 | 2.072 [52.63] Max |
| 3 | 3.108 [78.94] Max |
| 4 | 4.144 [105.26] Max |
| 5 | 5.180 [131.57] Max |
| 6 | 6.216 [157.89] Max |

Note: Tolerance ± .015 [.38] unless noted. Dimensions in brackets [] are millimeters
 Caution: Elongation of mounting holes may be necessary for units with more than 6 poles
 and units up to 12 poles due to tolerance compounding

229D (MARINE) & 279 (COMMUNICATION)

UL-1500 Ignition Protection

The 229D family is certified to UL-1500 which covers Ignition Protected circuit protectors. This specification requires devices to be used in accordance with the requirements of U.S. Coast Guard and Fire Protection Standard for Pleasure and Commercial Motor Craft, ANSI/MFPA No. 302.

The ratings available are 100 amperes or less at 65Vdc or 240Vac. Maximum IC, 1000 amperes. Consult factory for application details.

The 229D series is available with interlocking to prevent on board and shore power being used simultaneously.

Combination of ON-OFF switching the protection function offers a simplified solution for your electrical systems.

UL 489A Communications Equipment Protection

The 279 Series complies with the requirements of UL 489A, Circuit Breakers for use in Communication Equipment, meeting the need for protection at higher DC voltages.

The available ratings are 100 amperes or less at 160Vdc. Maximum short circuit interrupting current is 5000 amperes. The 279 series available only in a series trip configuration.

Please consult Sensata for specific application details.

209/219/229 CONFIGURATIONS

Series Trip

The most popular configuration for magnetic protectors is the series trip, where the sensing coil and contacts are in series with the load being protected. The handle position conveniently indicates circuit status. In addition to providing conventional overcurrent protection, it's simultaneously used as an ON-OFF switch.

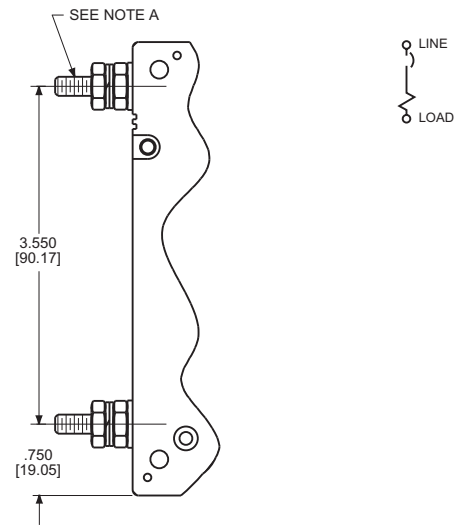

Auxiliary Switch

This is furnished as an integral part of a series pole in single or multi-pole assemblies. Isolated electrically from the protector's circuit, the switch works in unison with the power contacts and provides indication at a remote location of the protector's ON-OFF status.

(Applies to Series Trip Only)

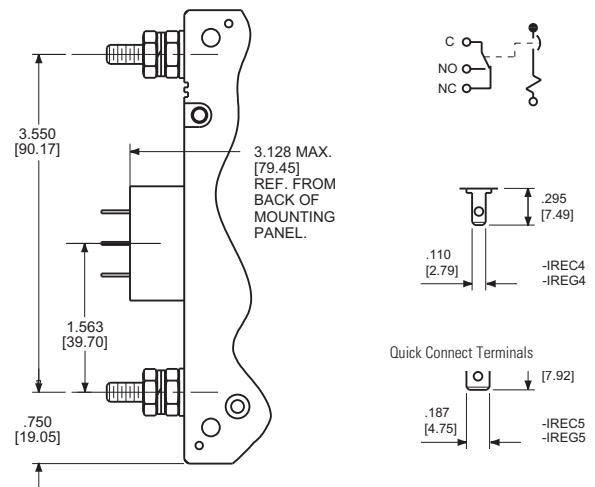

219/229 CONFIGURATIONS

Relay Trip

This permits the overload sensing coil to be placed in a circuit which is electrically isolated from the trip contacts. The coil may be actuated by sensors monitoring pressure, flow, temperature, speed, etc. Other typical applications include crowbar, interlock and emergency/rapid shutdown circuitry. Trip may be accomplished by voltage or current, which must be removed after trip.

Dual Coil

Providing for both a voltage trip and a current trip function in a magnetic circuit protector is common practice. These two coil protectors provide remote or automatic opening of one or more circuits with a low level signal.

The voltage coil will trip the protector instantaneously while the current coil provides normal inverse time delays. The voltage coil is not rated for continuous duty and therefore, the voltage must be removed when the breaker trips.

Since both coils are housed within the same pole, the space savings are substantial.

This option is not available with 64, 65 or 66 delays.

Shunt Trip

The shunt trip is designed for controlling two separate loads with one assembly. The control is established by providing overload protection for the critical load. When the current through this load becomes excessive and reaches the trip point, the protector will open and remove power from both loads simultaneously. The total current rating of both loads must not exceed the maximum contact rating.

Voltage Trip

Sometimes called "dump circuits" or "panic trip circuits," these units make it possible to open main power contacts with lower power inputs from one or more sources. This configuration is becoming increasingly more important for sensitive circuitry and denser packaging in automation systems.

Available in series, shunt or relay configurations.

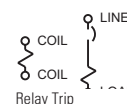
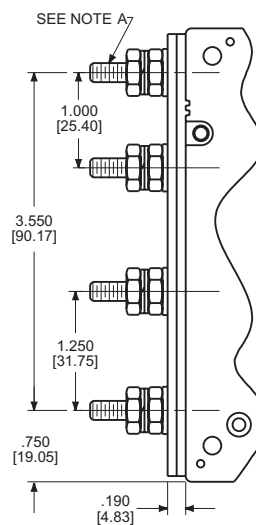

Dual Coil

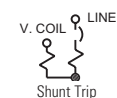
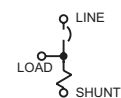
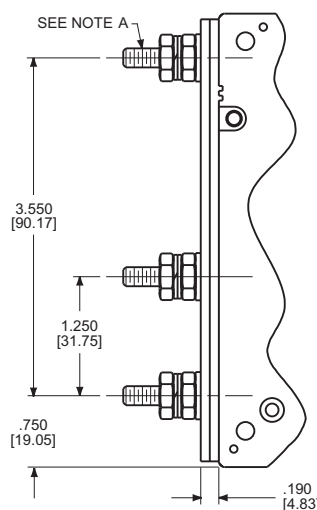

Dual Coil

Note:
Tolerance $\pm .015$ [38] unless noted. Dimensions in brackets [] are millimeters.
A: 0-50 Amps, 10-32 Studs $.625 \pm .062$ [15.88 \pm .157] Long, 51-100 Amps,
1/4 - 20 Studs, $.750 \pm .062$ [19.05 \pm .157] Long.

OPERATING CHARACTERISTICS

Inrush Pulse Tolerance

The table shown above provides a comparison of inrush pulse tolerance with and without the inertial delay feature for each of the 50/60Hz delays. Pulse tolerance is defined as a single pulse of half sine wave peak current amplitude of 8 milliseconds duration that will not trip the circuit breaker.

The table at right provides a reference guide for selecting the inertial delay feature. Consult factory for further assistance.

| INRUSH PULSE TOLERANCE | |
|------------------------|--------------------------------|
| Delay | Pulse Tolerance |
| 61, 62, 63 | 8 times rated current |
| 64 | minimum 20 times rated current |
| 65 | minimum 25 times rated current |
| 66 | minimum 30 times rated current |

Note: These limits do not apply to dual coil and tapped coil units

| PERCENTAGE OF RATED CURRENT VS TRIP TIME IN SECONDS AT +25°C | | | | | | | | |
|--|---------|------------|-----------|-----------|------------|------------|--------------|--------------|
| Delay | 100% | 125% | 150% | 200% | 400% | 600% | 800% | 1000% |
| 41 & 41F | No Trip | May Trip | .6 to 7 | .2 to 2 | .03 to .40 | .01 to .1 | .009 to .060 | .008 to .050 |
| 42 & 42F | No Trip | May Trip | 7 to 70 | 2 to 20 | .1 to 3 | .01 to .2 | .009 to .09 | .008 to .08 |
| 43 & 43F | No Trip | May Trip | 60 to 500 | 20 to 200 | 2 to 30 | .01 to .1 | .009 to .09 | .008 to .08 |
| 51 & 51F | No Trip | .4 to 7 | .2 to 2 | .12 to 1 | .03 to .3 | .012 to .1 | .009 to .07 | .008 to .05 |
| 52 & 52F | No Trip | 8 to 80 | 2.5 to 45 | .7 to 20 | .2 to 3 | .05 to 1 | .01 to .5 | .009 to .08 |
| 53 & 53F | No Trip | 100 to 900 | 50 to 500 | 20 to 200 | 2 to 25 | .015 to 5 | .01 to .15 | .009 to .09 |
| 61 | No Trip | .6 to 5 | .3 to 2 | .1 to .8 | .03 to .3 | .015 to .1 | .01 to .07 | .009 to .06 |
| 62 | No Trip | 12 to 120 | 6 to 55 | 2 to 18 | .3 to 3 | .05 to 1 | .016 to .1 | .01 to .08 |
| 63 | No Trip | 70 to 800 | 45 to 450 | 20 to 200 | 2 to 30 | .3 to 4 | .02 to .25 | .012 to .15 |
| 64 | No Trip | .6 to 5 | .3 to 3 | .1 to 1.5 | .03 to .5 | .02 to .4 | .01 to .3 | .008 to .25 |
| 65 | No Trip | 12 to 100 | 6 to 50 | 2 to 18 | .3 to 3 | .05 to 2 | .016 to 1.6 | .01 to 1 |
| 66 | No Trip | 70 to 800 | 45 to 450 | 20 to 200 | 2 to 30 | .3 to 9 | .02 to 5 | .013 to 3 |

*Notes: *279 is available only with DC delays*

209/219/229 DELAY CURVES

50/60 Hz Delay Curves (typ)

A choice of delays is offered for 50/60Hz applications.

Delay 61 is a short delay for general purpose applications. Delay 62 is long enough to start certain types of motors and most transformer and capacitor loads.

Delay 63 is a long delay for special motor applications.

Delays 64, 65 and 66 are the latest 50/60Hz delays with short, medium and long trip times respectively. The patented breaker design provides both increased tolerance to high inrush induced nuisance tripping and longer trip times at 600 percent. These delays are ideally suited for applications where thermal devices are presently used, such as motor protection or where short duration, high inrush currents are experienced. As shown in a typical motor start-up curve, the delay 66 will provide locked rotor and overload protection. Nuisance tripping is avoided, since acceptable short periods of overload will not trip the breaker.

All trip curves and trip currents are specified with the breaker mounted in the normal vertical position at ambient temperature of +25°C. For test and measurement purposes, the breakers should not carry current prior to application of overload for calibration test. For other than vertical mount position, consult factory.

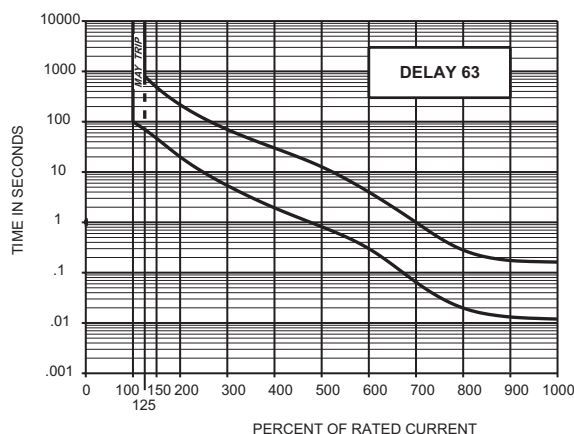
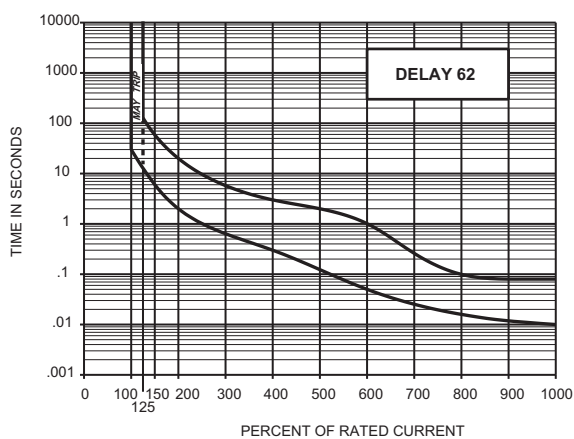
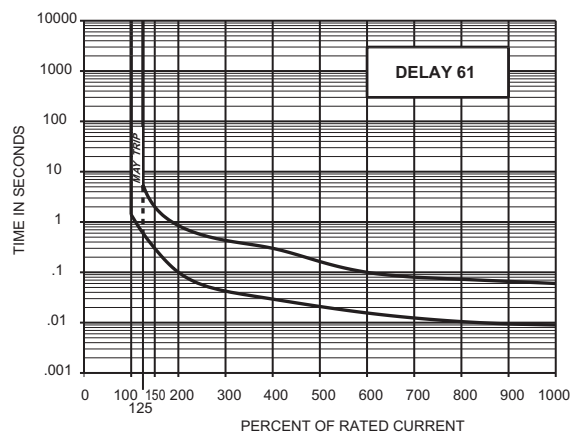

209/219/229/279 DELAY CURVES

60Hz Delay Curves (typ)

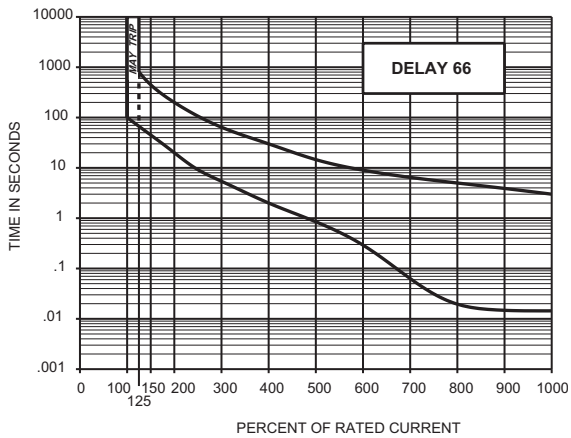
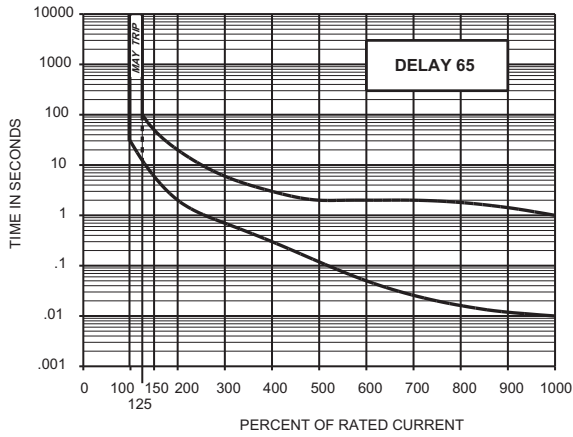
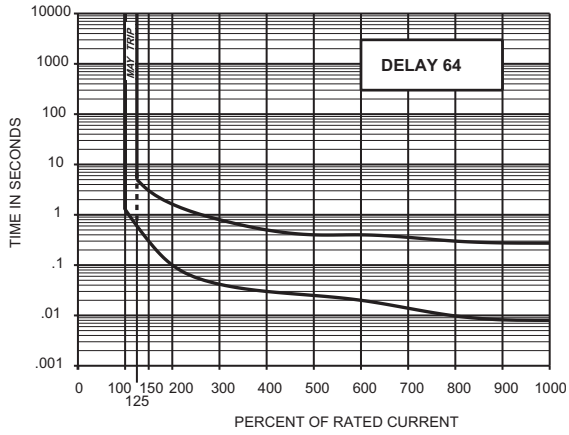

209/219/229 DELAY CURVES

DC Delay Curves (typ)
(279 is available only with DC delays)

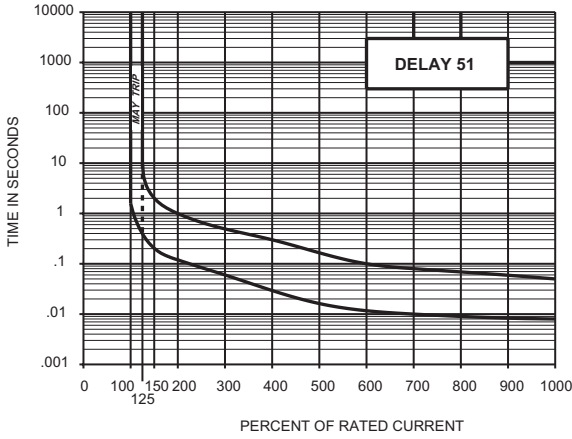

400Hz Delay Curves(typ)

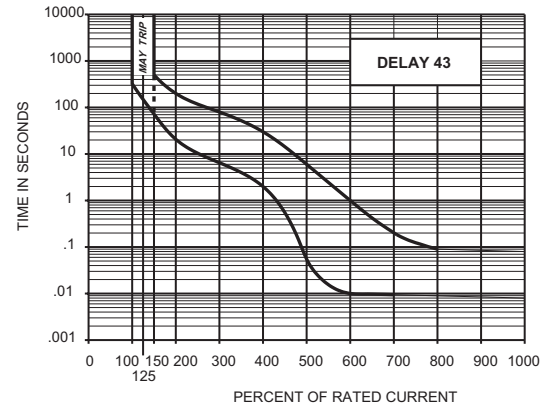
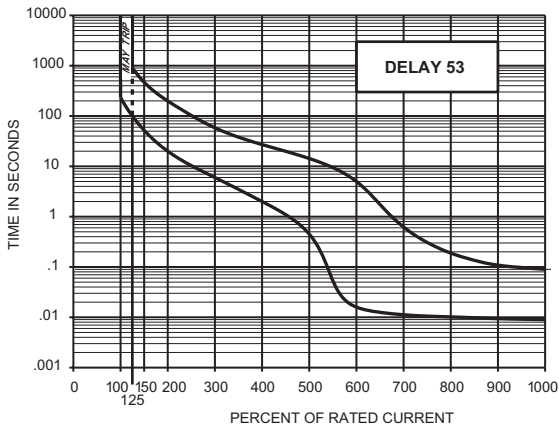
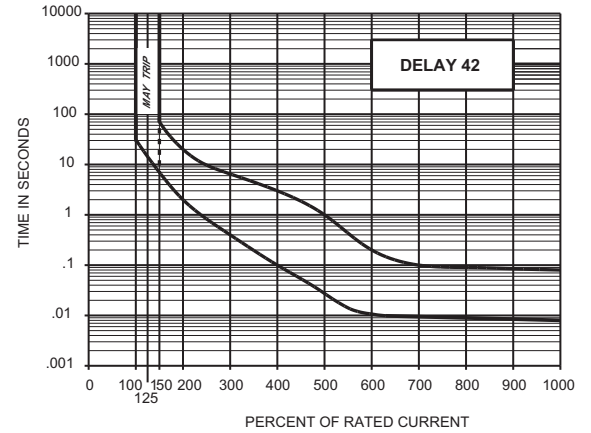
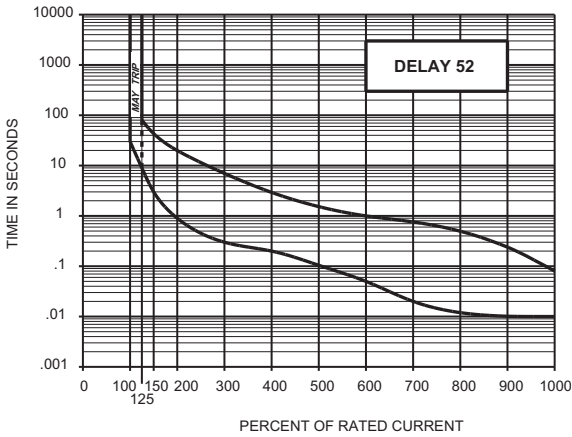
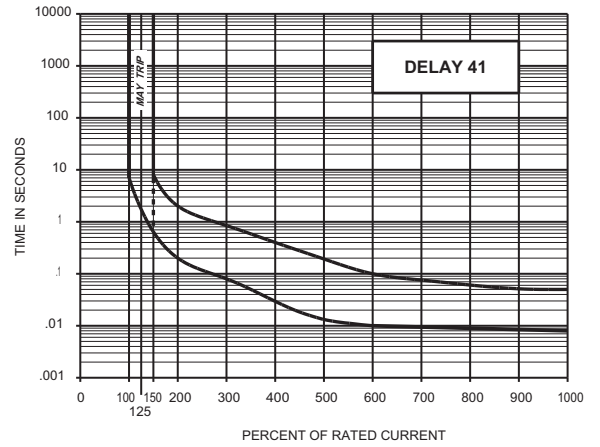

209/219/229 SPECIFICATIONS

| NOMINAL DCR / IMPEDANCE | | |
|---------------------------|-------------------|--------------------|
| Current Ratings (Amps) | Resistance (ohms) | Impedance (Ohms) |
| | DC Delays | AC, 50/60Hz Delays |
| | 51, 52, 53 | 61, 62, 63 |
| 0.10 | 112.0 | 117.0 |
| 1.0 | 0.97 | 1.0 |
| 5.0 | .042 | .044 |
| 10.0 | .011 | .012 |
| 20.0 | .0042 | .0043 |
| 30.0 | .0030 | .0031 |
| 50.0 | .0018 | .0019 |
| 80.0 | .0014 | .0015 |
| 100 | .0008 | .0009 |

*Notes: DCR and impedance based on 100% rated current applied and stabilized a minimum of one hour.
Tolerance: .1 amperes to 1.0 amperes, ± 10%; 1.1 amperes to 5.0 amperes, ± 15%; 5.1 amperes to 15 amperes, ± 25%; 15.1 amperes to 100 amperes, ± 50% or = .001 Ohms, whichever is greater.*

| APPROXIMATE CIRCUIT BREAKER WEIGHT | |
|------------------------------------|-------------|
| # of Poles | Ounces |
| 1 | 9 oz |
| 2 | 1 lb, 3 oz |
| 3 | 2 lb |
| 4 | 2 lb, 7 oz |
| 5 | 3 lb |
| 6 | 3 lb, 12 oz |

| RECOMMENDED TORQUE SPECIFICATIONS | |
|-----------------------------------|-----------------|
| Component | Torque (in-lbs) |
| 6-32 Mounting Inserts | 6 to 8 |
| M3 Mounting Screws | 4 to 5 |
| 1/4-20 Screw Terminals | 35 to 40 |
| 10-32 Stud Terminals | 13 to 14 |
| M5 Stud Terminals | 13 to 14 |
| 1/4 - 20 Stud Terminals | 40 to 45 |

Where applicable, mechanical support must be provide to the terminals when applying torque

Trip Free

Will trip open on overload, even when forcibly held on. This prevents the operator from damaging the circuit by holding the handle in the ON position.

Trip Indication

The operating handle moves positively to the OFF position on overload.

Environmental Specifications

Moisture and fungus resistance is provided by the use of moisture resistant finishes. Special springs and treatment for all ferrous parts eliminate inherent moisture-related problems. The use of fungi inert cases and handles avoids fungus-related problems.

Current Ratings

209/219/229 may be supplied with these ratings: DC, 50/60Hz, 400Hz, 0.1 to 100 amperes. 279 types may be supplied with DC ratings only, 0.1 to 100 amperes.

Voltage Ratings

On 209/219/229, voltages up to and including 240Vac, 50/60Hz or 400Hz, or 125Vdc are available. Multi-pole units can be supplied for 277Vac/480Vac, 50/60Hz. 279 types are available with a voltage of 160Vdc. All units will be marked with the standard maximum voltage. UL Listed breakers will be labeled with the UL listed voltage.

Auxiliary Switch Ratings

When supplied shall be S.P.D.T. configuration with a maximum rating of 10 amperes 250Vac.

Mounting Considerations

A three-inch spacing must be provided between the circuit breaker and vent and any conductive surface. If closer than three inches is necessary, then an insulator must be installed on the conductive surface.

Solderless Connectors

Connectors are rated AL9 CU. and accept either copper or aluminum conductors. Units are suitable for use with both 60° and 75° wire. Optional pressure plate for fine stranded wire is available. Contact factory for details.

209 SERIES AGENCY APPROVALS

| Volts (Volts) | | | Rated Current (Amps) | | | Interrupting Capacity (Amps) | | |
|--|----------------|------------|----------------------|---------|--------------|------------------------------|--|--|
| Voltage (V) | Frequency (Hz) | Min. Poles | UL/CSA | VDE | UL 489 & CSA | VDE | | |
| 65 | DC | 1 | .10-100 | - | 25000 | - | | |
| 125 | DC | 1 | .10-125 | .10-100 | 10000 | 4000 | | |
| 125/250 | DC | 2 | .10-20 | - | 5000 | - | | |
| 120 | 50/60 | 1 only | .10-50 | - | 10000 | - | | |
| 120/240 | 50/60 | 2 | .10-100 | - | 5000 | - | | |
| 120/240 | 50/60 | 2 only | .10-50 | - | 10000 | - | | |
| 240 | 50/60 | 1 | .10-100 | .10-100 | 5000 | 4000 | | |
| 240 | 400 | 1 | .10-100 | - | 2500 | - | | |
| 239 Circuit Breakers (Marine) | | | | | | | | |
| Voltage (V) | Frequency (Hz) | Min. Poles | UL/CSA | VDE | UL489 & CSA | VDE | | |
| 125 | DC | 1 | .10-100 | - | 5000 | - | | |
| 279 Circuit Breakers for use in Communications Equipment | | | | | | | | |
| Voltage (V) | Frequency (Hz) | Min. Poles | UL/CSA | VDE | UL489A | VDE | | |
| 160 | DC | 1 | .10-100 | - | 5000 | - | | |

219 MANUAL MOTOR CONTROLLERS AGENCY APPROVALS

| Volts (Volts) | | | Rated Current (Amps) | | Interrupting Capacity (Amps) | |
|---------------|----------------|------------|----------------------|---------|------------------------------|------|
| Voltage (V) | Frequency (Hz) | Min. Poles | UL | VDE | UL 508 | VDE |
| 125 | DC | 1 | .10-100 | .10-100 | 5000 | 4000 |
| 120/240 | 50/60 | 2 | .10-100 | - | 5000 | - |
| 120/240 | 50/60 | 2 | .10-100 | - | 10000 | - |
| 240 | 50/60 | 1 | .10-100 | .10-100 | 5000 | 4000 |
| 240/415 | 50/60 | 2 | - | .10-100 | - | 4000 |
| 277 | 50/60 | 1 | .10-100 | - | 5000 | - |
| 277/480 | 50/60 | 2 | .10-100 | - | 5000 | - |
| 277/480 | 50/60 | 2 | .10-100 | - | 10000(1) | - |
| 480 | 50/60 | 2 | .10-100 | - | 10000(1) | - |
| 600 | 50/60 | 2 | .10-77 | - | 10000(1) | - |
| 250 | 400 | 1 | .10-100 | - | 5000 | - |

Notes: (1) With 225 A maximum series fuse

229 SUPPLEMENTARY PROTECTORS* AGENCY APPROVALS

| Volts (Volts) | | | | | Rated Current (Amps) | | | | Interrupting Capacity (Amps) | | |
|---|----------------|------|------|-------|----------------------|----|-------------|---------|------------------------------|--------------------------|------|
| Voltage (V) | Frequency (Hz) | UG | FW | Phase | Min. Poles | TC | OL | UL/CSA | VDE | UL 1077 & CSA No. 235 | VDE |
| 125 | DC | A, D | 0 | - | 1 | 1 | 0 | .10-100 | .10-100 | U2, 10000 / U1, 5000 | 4000 |
| 125 | DC | A, D | 0, 3 | - | 1 | 1 | 0 | .10-120 | .10-100 | U2, 5000 / U1, 5000 | 4000 |
| 125/250 | DC | A, D | 0, 3 | - | 2 | 1 | 1 | .10-20 | - | U1, 5000 | - |
| 300 | DC | A, D | 0, 3 | - | 2 | 1 | 0 | .10-100 | - | U1, 5000 | - |
| 125/250 | 50/60 | A, D | 0 | 1 | 2 | 1 | 1 | .10-115 | - | U2, 5000 | - |
| 125/250 | 50/60 | A, D | 0 | 1 | 2 | 1 | 0 | .10-100 | - | U1, 10000 | - |
| 250 | 50/60 | A, D | 0, 3 | 1 | 1 | 1 | 0 | .10-100 | - | U1, 5000 | - |
| 277 | 50/60 | A, D | 0, 3 | 1 | 1 | 1 | 1 | .10-100 | - | U1, 5000 | - |
| 277/480 | 50/60 | A, D | 0 | 1 & 3 | 2 | 1 | 1 | .10-100 | - | C2, 10000(1) / C1, 10000 | - |
| 277/480 | 50/60 | A, D | 0, 3 | 1 & 3 | 2 | 1 | 0 | .10-100 | - | U2, 5000 / U1, 5000 | - |
| 347/600 | 50/60 | A, D | 0 | 1 & 3 | 2 | 1 | 0 | .10-100 | - | C1, 10000(1) | - |
| 347/600 | 50/60 | A, D | 0, 3 | 1 & 3 | 2 | 1 | 0 | .10-100 | - | U1, 5000 | - |
| 480 | 50/60 | A, D | 0 | 3 | 3 | 1 | 0 | .10-100 | - | C2, 10000(1) / C1, 10000 | - |
| 600 | 50/60 | A, D | 0 | 3 | 3 | 1 | 0 | .10-77 | - | C2, 10000(1) / C1, 10000 | - |
| 125/250 | 400 | A, D | 0, 3 | 1 | 2 | 2 | 0 | .10-100 | - | U2, 1500 / U1, 2000 | - |
| 229D Supplementary Protectors (Ignition Protected) | | | | | | | | | | | |
| Voltage (V) | Frequency (Hz) | UG | FW | Phase | Min. Poles | TC | OL | UL/CSA | VDE | UL1500 & CSA | VDE |
| 65 | DC | A, D | 0, 3 | - | 1 | 1 | 1, (0, CSA) | .10-100 | - | U2, 1000/U1,1000 | - |
| 250 | 50/60 | A, D | 0, 3 | 1 | 1 | 1 | 1, (0, CSA) | .10-100 | - | U2, 1000/U1, 1000 | - |
| 229G Supplementary Protectors (Generator Use – UL489 Field wired) | | | | | | | | | | | |
| Voltage (V) | Frequency (Hz) | UG | FW | Phase | Min. Poles | TC | OL | UL/CSA | VDE | UL1077 & CSA | VDE |
| 277/480 | 50/60 | A, D | 0, 3 | 3 | 3 | 1 | 1 | .10-100 | - | U2, 2500 | - |
| 347/600 | 50/60 | A, D | 0, 3 | 3 | 3 | 1 | 1 | .10-77 | - | U2, 2000 | - |
| 239 Supplementary Protectors (Marine) | | | | | | | | | | | |
| Voltage (V) | Frequency (Hz) | UG | FW | Phase | Min. Poles | TC | OL | UL/CSA | VDE | UL1077 & CSA | VDE |
| 250 | 50/60 | A, D | 0, 3 | 1 & 3 | 1 | 1 | 1 | .10-100 | - | U1, 5000 | - |
| 125/250 | 50/60 | A, D | 0, 3 | 1 | 2 | 1 | 1 | .10-100 | - | U1, 5000 | - |
| 240 | 50/60 | - | - | 1 & 3 | 1 | - | - | .10-100 | - | 4000 | - |
| 240/415 | 50/60 | - | - | 3 | 3 | - | - | .10-100 | - | 4000 | - |

Notes: (1) With 225A maximum series fuse

*219 also applicable for CSA approval only.

General notes

All supplementary protectors are of the overcurrent (OC) type
 The family of protectors has been evaluated for end use application for use group (UG) A and D

The terminals (FW) – Terminals are coded as follows:

- 0 – Suitable for factory wiring only
- 1 – Line terminals evaluated for field wiring
- 2 – Load terminals evaluated for field wiring
- 3 – Line and Load terminals evaluated for field wiring

The maximum voltage ratings for which the protectors have been tested are shown in the chart

The current is the amperage range that the protectors have been tested

The tripping current (TC) – Tripping Current is coded as a percentage of the ampere rating:

- 0 – Tripping current is less than 125% of ampere rating
- 1 – Tripping current is in the range of 125% to 135% of ampere rating
- 2 – Tripping current is more than 135% of ampere rating
- 3 – Tripping current is 135% and meets MCCB trip time requirements

The overload rating (OL) - Designates whether the protector or family of protectors has been tested for general use or motor starting applications.

- 0 – tested at 1.5 times amp rating for general use
- 1 – tested at 6 times AC rating or 10 times DC rating for motor starting

The short circuit current rating (SC) – The short circuit rating in amperes following a letter and number designating the test conditions and any calibration following the short circuit test is defined below:

- C – Indicates short circuit test was conducted with series overcurrent protection
- U – Indicates short circuit test was conducted without series overcurrent protection
- 1 – Indicates a recalibration was not conducted as part of the short circuit testing
- 2 – Indicates a recalibration was performed as part of the short circuit testing
- 3 – Indicates recalibration was performed along with the dielectric and voltage withstand for “Suitable for Further Use” rating

209/219/229/279 DECISION TABLES

How to Order

The ordering code for 209, E-Frame Circuit Breakers may be determined by following the steps in the decision tables shown here.

The coding given permits a self-assigning part number for standard configurations. Factory part numbers are assigned to units with mixed ratings, combinations of styles or construction not listed in the Third Decision Table, etc. With these, it is suggested that order entry be by description and/or drawings, and a part number will be established.

Additionally, it is standard policy to establish a factory-assigned part number whenever a descriptive drawing exists to insure cross reference, traceability and manufacturing control.

When specifying a breaker for AC motor start or high inrush applications, the peak amplitude and surge duration should be specified for factory assistance in rating selection. 209 and 239 are UL listed circuit breakers under file no. E53739 per UL 489.

279 is a UL listed under file no. E192808 per UL 489A.

219 is a UL recognized "Manual Motor Controller" under file no. E41607 per UL 508.

229 is a UL recognized supplementary protector under file no. E66410 per UL 1077.

For example, the following is the code for a single pole breaker with series trip, 50/60Hz, medium inertial delay, 120/240Vac maximum voltage ratings, solderless connector with mounting foot added to the line side of the breaker to facilitate back panel mounting and a current rating of 10.0 amperes.

To determine the ordering number of your particular 209 unit, simply follow the steps shown. You may use this number to place an order or as a reference for further questions you may have.

Notes:

- A 6-32 inserts for front mounting are provided on all units. M3 ISO metric mounting inserts are available and are specified by adding -A at the end of the ordering code above.
- B The auxiliary switch is located on the right-hand pole (viewed from terminal end) unless specified otherwise. Auxiliary switches are available on all front or back panel mounts (series construction only). If more than one auxiliary switch is specified use "2R" through "6R" as required.

- C Line terminals are 10-32 screws for bus connection to 100 amperes. Load terminals are 10-32 screws to 50 amperes and solderless connectors from 50 to 100 amperes.
- D An anti-flashover barrier is supplied between poles on all multi-pole versions with 10-32 stud and 1/4-20 stud terminals per UL requirement.
- E The standard current values for 100% of rated current are those listed in the Seventh Decision Table. Non-listed values can be readily supplied, in general without delayed delivery. Please contact an Airpax office or sales representative.

| 1 First Decision | |
|--|--|
| Type | |
| 209* | Magnetic Branch Circuit Breaker, UL 489 Listed |
| 219 | Manual Motor Controller, UL 508 Recognized |
| 229 | Supplementary protector, UL 1077 Recognized |
| 279** | Magnetic Circuit Breakers for use in Communication Equipment, UL 489A Listed |
| 229D | Marine Ignition Protection, UL 1500 Recognized |
| 239* | Magnetic Branch Circuit Breaker, UL 489 Listed (marine) DC only. |
| 299 | Special Construction, not UL Listed or Recognized |
| <small>* UL 489 Listed units are rated to 125Vdc maximum. ** UL 489A Listed units are rated to 160Vdc maximum.</small> | |

| 2 Second Decision | |
|-------------------|------------------|
| Poles | |
| -1 | Single pole unit |
| -2 | Two pole unit |
| -3 | Three pole unit |
| -4 | Four pole unit |
| -5 | Five pole unit |
| -6 | Six pole unit |

3 Third Decision

Configurations

| | |
|--------|--|
| -0 | Switch only |
| -1 | Series |
| -1REC4 | Auxiliary switch* (std.) .110 quick connect |
| -1REG4 | Auxiliary switch* .110 quick connect † |
| -1REC5 | Auxiliary switch* .187 quick connect |
| -3 | Shunt (up to 50 amp only)** |
| -4 | Relay (up to 50 amp only)** |

† Gold contacts
 * Switch is located in the right hand pole (viewed from terminal end) unless otherwise specified.
 ** Not available in 209 type.

Example:

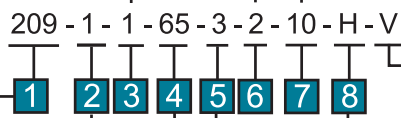

6 Sixth Decision

Terminal Selection

| | Terminal | Terminal Connect | Panel Mount |
|-----|--------------------------------|------------------|-----------------|
| -1 | Solderless connector | front | front (Note A) |
| -2 | Solderless connector | front | back* |
| -2C | Solderless connector | front | back** |
| -3 | 10-32 screw (100 amps max.) | bus connect | back (Note C)* |
| -3C | 10-32 screw (100 amps max.) | bus connect | back (Note C)** |
| -4 | 10-32 screw (50 amps max.) | front | front |
| -5 | 10-32 screw (50 amps max.) | front | back* |
| -5C | 10-32 screw (50 amps max.) | front | back** |
| -6 | 1/4 - 20 screw (100 amps max.) | front | front |
| -7 | 1/4 - 20 screw (100 amps max.) | front | back* |
| -7C | 1/4 - 20 screw (100 amps max.) | front | back** |
| -8 | 10 - 32 stud (50 amps max.) | back | front (Note D) |
| -9 | 1/4 - 20 stud (100 amps max.) | back | front (Note D) |
| -3M | M5 x 0.8 screw (100 amps max.) | bus connect | back (Note C)* |
| -4M | M5 x 0.8 screw (50 amps max.) | front | front |
| -5M | M5 x 0.8 screw (50 amps max.) | front | back* |
| -6M | M6 x 1.0 screw (100 amps max.) | front | front |
| -7M | M6 x 1.0 screw (100 amps max.) | front | back* |
| -8M | M5 x 0.8 stud (50 amps max.) | back | front (Note D) |
| -9M | M6 x 1.0 stud (100 amps max.) | front | front (Note D) |

* Back panel mount style supplied with slotted mounting bracket. Solderless connector will accept #14 through 0 copper or #12 through 0 aluminum wire.
 ** Back panel mount style supplied with short mounting bracket.

4 Fourth Decision

Hz and Delay

| Standard | | Option |
|----------|----------------------------------|--------|
| 41 | 400Hz short delay | 41F |
| 42 | 400Hz medium delay | 42F |
| 43 | 400Hz long delay | 43F |
| 50 | DC instant trip | |
| 51 | DC short delay | 51F |
| 52 | DC medium delay | 52F |
| 53 | DC long delay | 53F |
| 60 | 50/60Hz instant trip | |
| 61 | 50/60Hz short delay | |
| 62 | 50/60Hz medium delay | |
| 63 | 50/60Hz long delay | |
| 64 | 50/60Hz short delay (high pulse) | |
| 65 | 50/60Hz long delay (high pulse) | |
| 66 | 50/60Hz motor delay (high pulse) | |
| SW | Switch only (no delay) | |

An "F" after any delay denotes high pulse tolerance construction.

5 Fifth Decision

Voltage and Current

| | Maximum Voltage | Maximum Current (Amperes) |
|------|-----------------|---------------------------|
| -1 | 65Vdc†† | 100 |
| -2 | 125Vdc | 100 |
| -3 | 120/240Vac | 100 |
| -4 | 240Vac | 100 |
| -5* | 277/480Vac† | 100 |
| -6 | 277Vac | 100 |
| -7* | 600Vac | 77 |
| -8* | 480Vac ††† | 100 |
| -9** | 160 Vdc | 100 |

* Multi-pole only
 ** For 279 ratings only
 † 240/415Vac iWyei only for VDE
 †† For 229D ratings only
 ††† Two poles breaking minimum

V = VDE Approved

The shaded areas denote VDE Approval options. This approval requires the addition of a V at the end of the part number. The V will be added to any part number formed entirely from shaded decisions. If non-shaded areas are selected, the unit will not be VDE Approved, but other approvals still apply.

7 Seventh Decision

Current Ratings

| Amps | Amps |
|------|------|
| .1 | 10 |
| .25 | 15 |
| .5 | 20 |
| 1 | 25 |
| 2 | 30 |
| 2.5 | 50* |
| 3 | 60 |
| 5 | 70 |
| 7.5 | 100* |

Non-Standard currents are available. (Note E).
 *Switch only ratings.

8 Eighth Decision

Optional

| | |
|---|-------------------------------------|
| A | Metric mounting inserts M3 (Note A) |
| H | International handle markings |

Multi-pole units with mixed construction poles numbered left to right when viewed from terminal end.

249 POWER SELECTOR BREAKER SYSTEM DECISION TABLES

How to Order

To evolve a convenient ordering system for most applications, the following code has been developed. If a system is required which is not covered below, please consult factory or describe in detail. The number shown as an example describes a 120 volt, three section system, such as may be used on a boat with a port and starboard shore power receptacle and an AC generator. The breaker rating for the shore power is 30 amperes and for the generator 20 amperes in this example. 1/4 - 20 screw type terminals and a medium time delay are specified.

| 1 First Decision | |
|-----------------------|---|
| Total Number of Poles | |
| -2 | 2 |
| -4 | 4 |
| -6 | 6 |
| -8 | 8 |
| -9 | 9 |

| 2 Second Decision | | |
|-----------------------|----------------------|---------------------------|
| Total Number of Poles | | |
| Code | Number of Selections | Breaker Poles Per Section |
| -A | 2 | 1 |
| -B | 2 | 2 |
| -C | 3 | 2 |
| -D | 4 | 2 |
| -E | 2 | 3 |
| -F | 3 | 3 |

| 3 Third Decision | |
|---|--|
| Current Rating (Each Section) | |
| Indicate the actual rating from the list below for each section (left to right when viewed from front.) | |
| -10, -15, -20, -25, -30, -50, -60, -70, -100 | |

| 4 Fourth Decision | |
|--|-------------------------------------|
| Terminals | |
| -1* | Box type solderless wire connect |
| -2 | 1/4 - 20 screw |
| -3 | 1/4 - 20 stud (for back connection) |
| * -1 box type connector not supplied on 239 marine applications. | |

Example:

249 - 6 - C - 20 - 30 - 30 - 2 - 62 - 1

1
2
3
3
3
4
5
6

| 5 Fifth Decision | |
|------------------|------------------------|
| Trip Time Delay | |
| -51 or 51F | Short DC |
| -52 or 52F | Medium DC |
| -53 or 53F | Long DC |
| -61 | Short AC |
| -62 | Medium AC |
| -63 | Long AC |
| -64 | Short AC (high pulse) |
| -65 | Medium AC (high pulse) |
| -66 | Long AC (high pulse) |

| 6 Sixth Decision | |
|------------------|--------------------------|
| Application | |
| -1 | Marine (239 Breaker) |
| -2 | Industrial (209 Breaker) |

AIRPAX[®]

JAE Series Magnetic Circuit Protectors

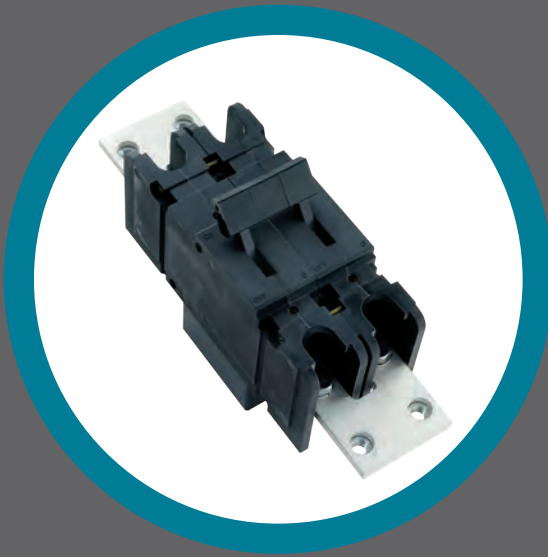

| | | |
|----------------------------------|---|------------|
| <i>Introduction</i> | • | 205 |
| <i>Poles</i> | • | 207 |
| <i>Configurations</i> | • | 211 |
| <i>Operating Characteristics</i> | • | 213 |
| <i>Delay Curves</i> | • | 216 |
| <i>Decision Tables</i> | • | 217 |



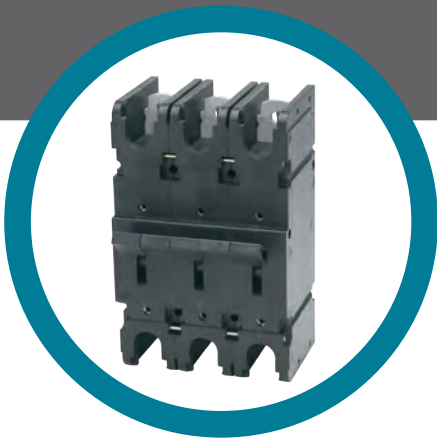

AIRPAX® | JAE/JRE/JLE Series Hydraulic Magnetic Circuit Protectors

INTRODUCTION

In today's applications, ambient operating temperatures present circuit protection challenges for many design engineers. High current thermal protective devices may not provide the desired degree of protection. The JAE/JRE/JLE series magnetic-hydraulic circuit protector addresses this issue by providing circuit protection for high current applications with a consistent trip point over temperatures ranging from -40°C to $+85^{\circ}\text{C}$.

The JAE/JRE/JLE series is actually a family of circuit protectors available in one to six pole assemblies with a variety of configurations and terminal styles. The principle member of

this family is the JLE, an F-frame "listed circuit breaker" which complies with conditions of UL-489. Other members of the family include the JTE, for telecommunication applications and complies to UL-489A, and the JAE, a special construction version. In addition, the JAE is now in compliance with the standards used in Australia and New Zealand, AS 60947.2-2005 (equivalent to IEC 60947-2:2006+A1).

The JAE/JRE/JLE series magnetic-hydraulic circuit protector provides circuit protection for high current applications. It provides a consistent trip point over temperatures ranging from -40°C to $+85^{\circ}\text{C}$.

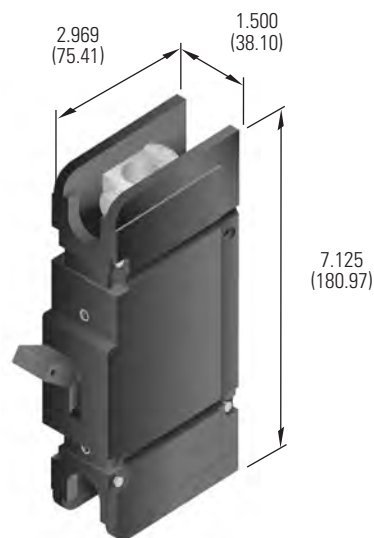

General Description

- mid-trip handle available for visual identification of fault-tripped circuit breakers
- optional internal low voltage shunt to meter current (single and multi-pole units are dimensionally equivalent in depth)
- terminal options for design flexibility in various applications
- multiple trip time delays for application flexibility
- electrical and mechanical actuated auxiliary switch options for external monitoring of circuits
- reduced voltage drop through the circuit breaker vs. other circuit protective devices

Number of Poles

- 1, 2, 3, 4, 5, 6

Current and Voltage Ratings

- 100 to 250 amps, 160Vdc
- 100 to 250 amps, 125/250Vdc
- 100 to 250 amps, 65Vdc
- 275 to 800 amps, 160Vdc (paralleled poles)
- 275 to 1200 amps, 65Vdc (paralleled poles)

Interrupting Capacity

- 10,000 amps, 160Vdc
- 10,000 amps, 125/250Vdc
- 100,000 amps, 65Vdc (1 amps to 800 amps)
- 10,000 amps, 160Vdc (ratings \leq 1000 amps)
- 65,000 amps, 65Vdc (801 amps to 1200 amps)

Approvals

- UL 489 Listed
- UL 489A Listed
- CSA Certified
- CUL/CUR Certified
- VDE Certified
- CCC Certified
- AS 60947.2-2005 (equivalent to IEC 60947-2:2006+A1)

Single-pole ratings: UL489, 250 amps max at 160 Vdc, 10,000 amp interrupting capacity and 250 amps max at 65 Vdc, 65,000 amp interrupting capacity. Multi-pole ratings: UL 489A, 800 amps max at 160 Vdc, 10,000 amp interrupting capacity and 1,200 amps max at 65 Vdc, 65,000 amp interrupting capacity.

ISO-9001 Certified

**Optional
Metering Shunt**

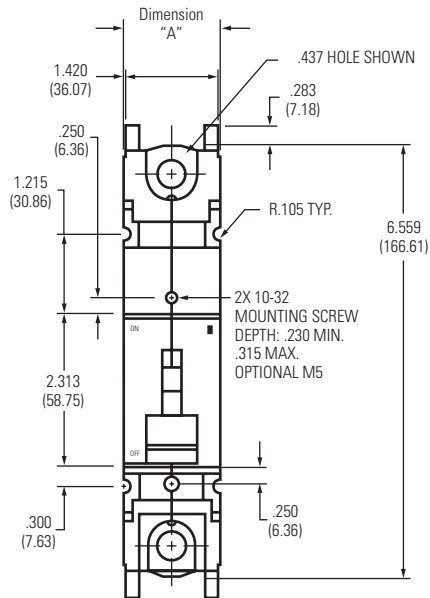
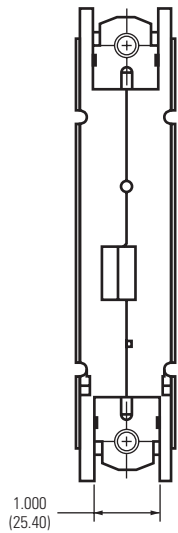
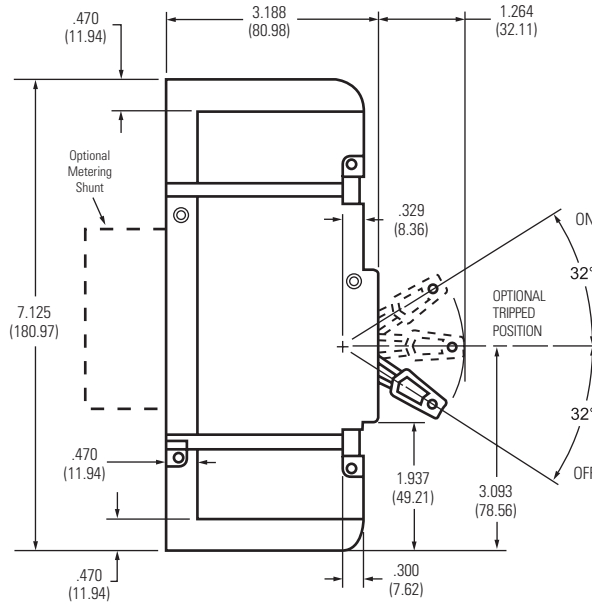
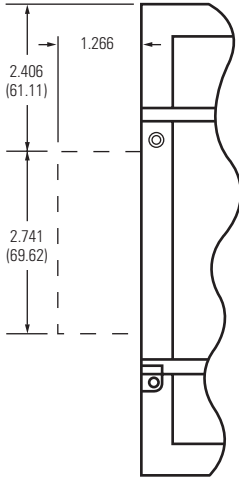

Terminal Configuration

Captive Nut (-F1)

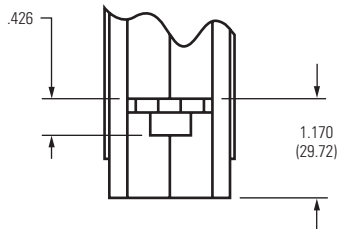

Stud (-B3)

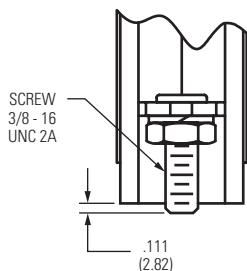

Long Stud (-B4)

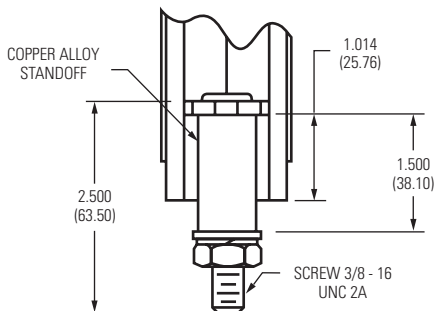

Solderless Connector (-F0)

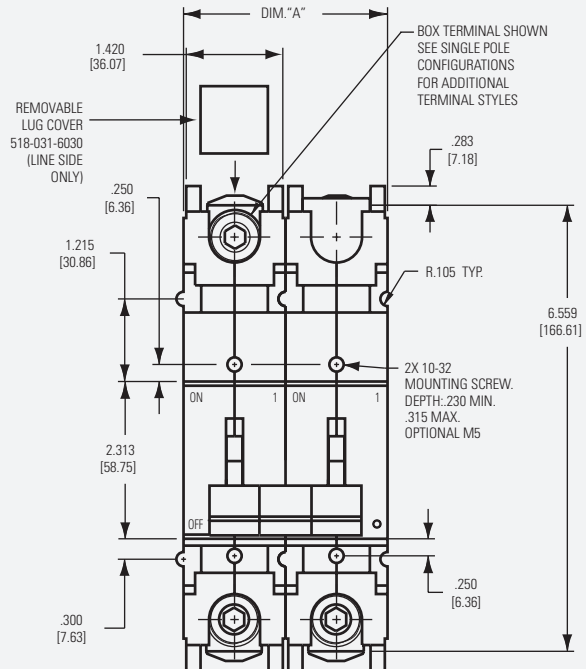
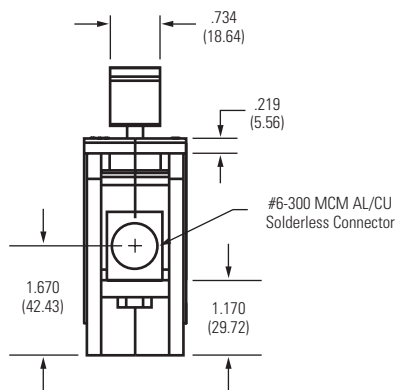

| MULTI-POLE DIMENSIONS | |
|-----------------------|--------------------|
| Number of Poles | Dimension "A" |
| 1 | 1.500 [38.10] Max |
| 2 | 3.000 [76.20] Max |
| 3 | 4.500 [114.30] Max |
| 4 | 6.000 [152.40] Max |
| 5 | 7.500 [190.50] Max |
| 6 | 9.000 [228.60] Max |

| PARALLEL MULTI-POLE ASSEMBLIES | | | |
|--------------------------------|-----------------|--------------------|--------------------|
| Amp Range | Number of Poles | Dimension "A" | Dimension "B" |
| 275 to 400 | 2 | 2.375 [60.33] Max | 3.000 [76.20] Max |
| 450 to 600 | 3 | 3.875 [98.43] Max | 4.500 [114.30] Max |
| 650 to 800 | 4 | 5.375 [136.53] Max | 6.000 [152.40] Max |
| 850 to 1000 | 5 | 6.875 [174.63] Max | 7.500 [190.50] Max |
| 1050 to 1200 | 6 | 8.375 [212.73] Max | 9.000 [228.60] Max |

Note: Tolerance of ± 0.030 [0.762]

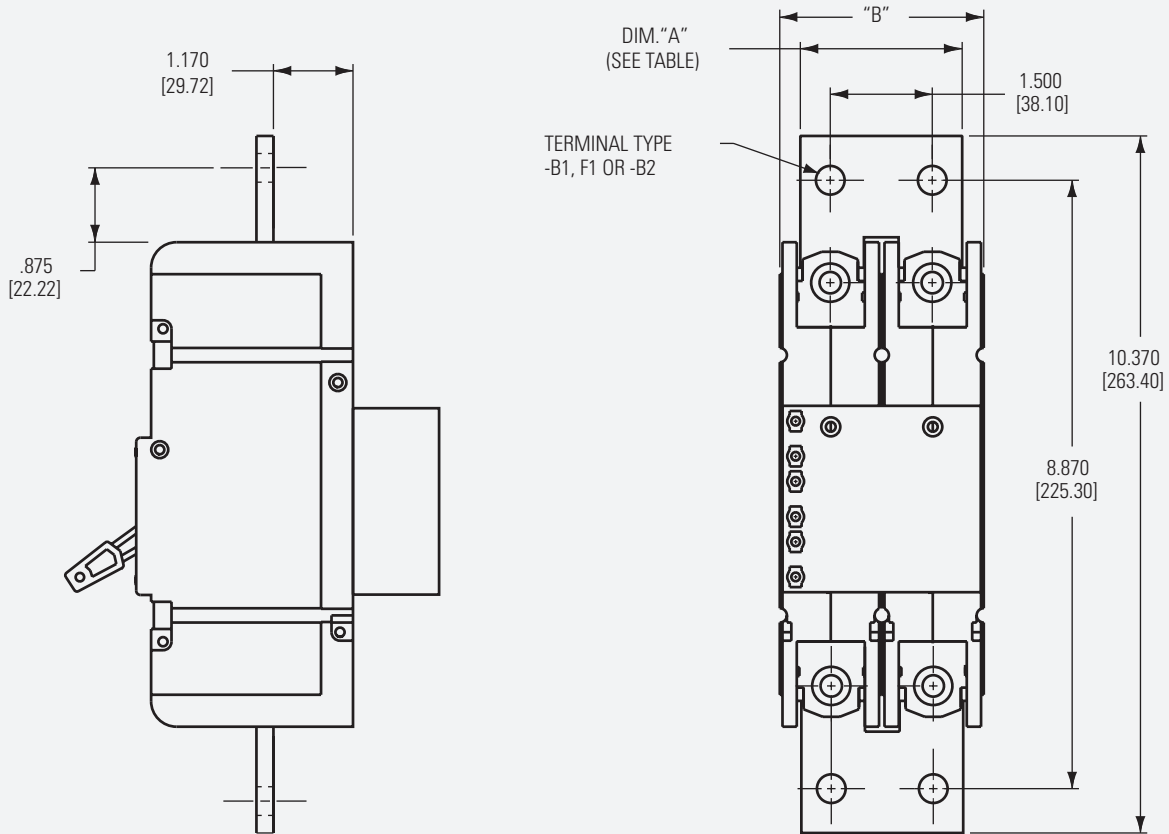

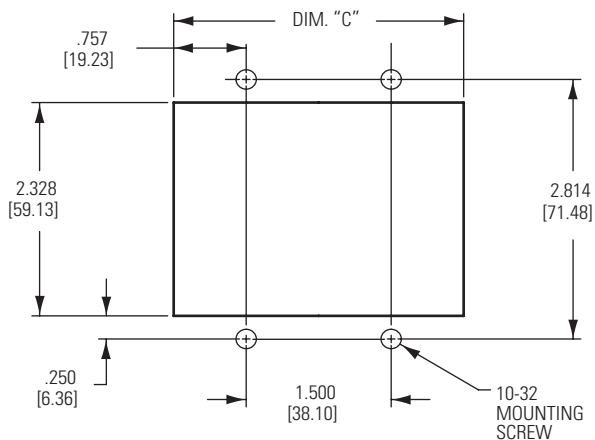

| PANEL MOUNTING DETAILS | |
|------------------------|--------------------|
| Number of Poles | Dimension "C" |
| 1 | 1.515 [38.48] Max |
| 2 | 3.015 [76.58] Max |
| 3 | 4.515 [114.68] Max |
| 4 | 6.015 [152.78] Max |
| 5 | 7.515 [190.88] Max |
| 6 | 9.015 [228.98] Max |

Notes:

1. All mounting inserts shall be utilized when panel mounting circuit breakers. Panel mounting screws shall have recommended torque applied.
2. Panel mounting screws shall not extend beyond back of mounting panel more than specified mounting insert depth.

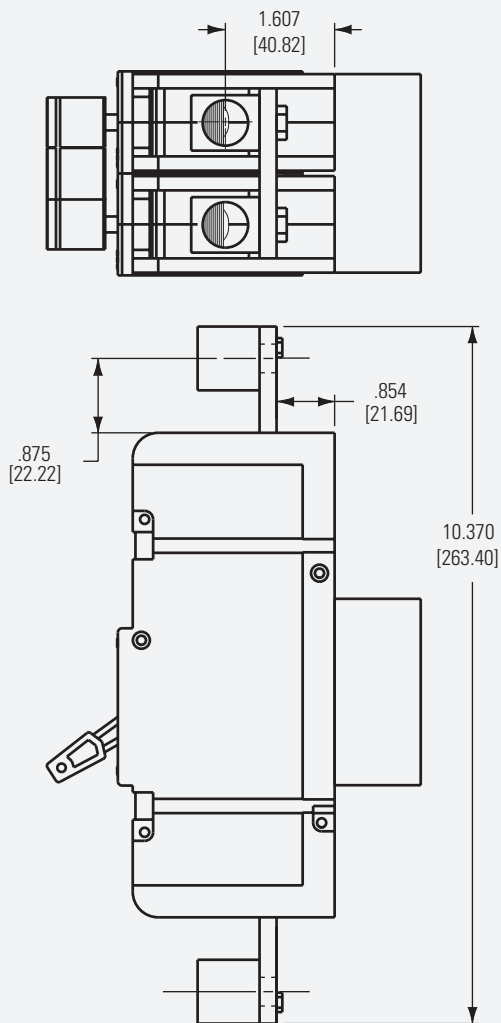
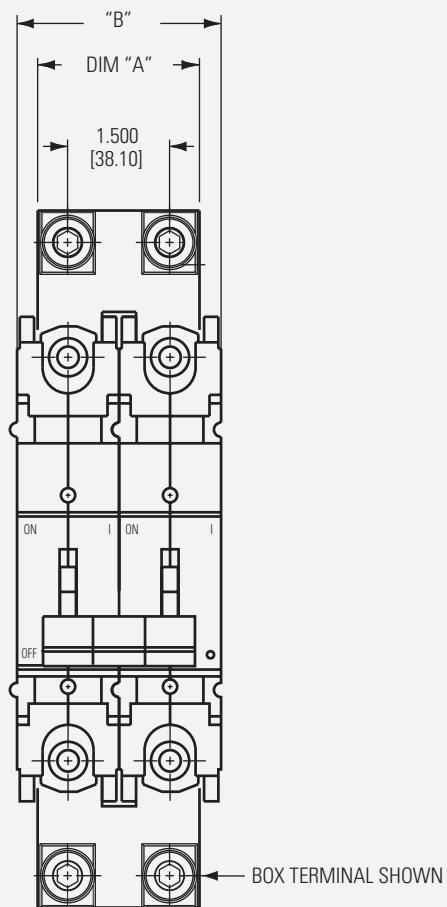

CONFIGURATIONS

Series Trip

The most popular configuration for magnetic protectors is the series trip, where the sensing coil and contacts are in series with the load being protected. The handle position conveniently indicates circuit status. In addition to providing conventional overcurrent protection, it's simultaneously used as an on-off switch.

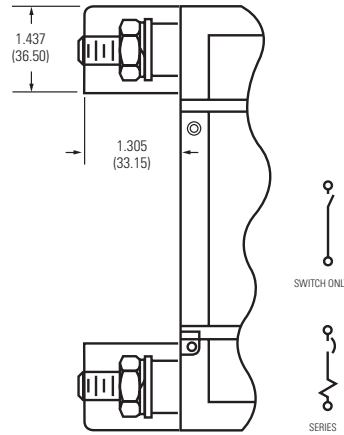

Auxiliary Switch

This is furnished as an integral part of a series pole in single or multi-pole assemblies. Isolated electrically from the protector's circuit, the switch works in unison with the power contacts and provides indication at a remote location of the protector's on-off status.

Alarm Switch

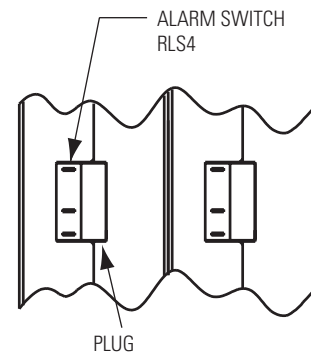

Auxiliary Switch

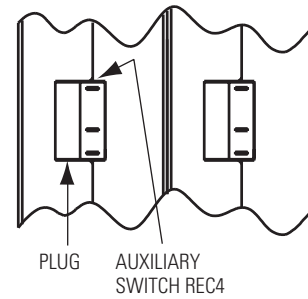

Alarm & Auxiliary Switch Combination

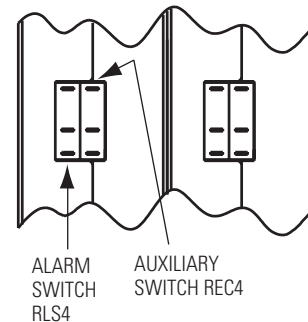

Series with Auxiliary Switch Configurations

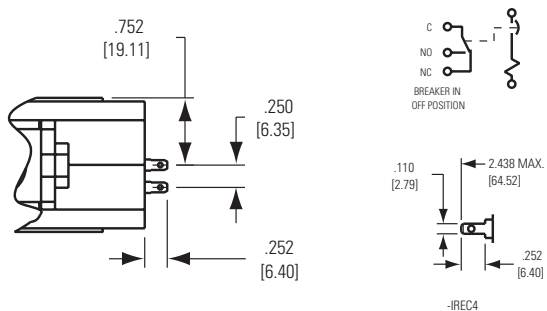
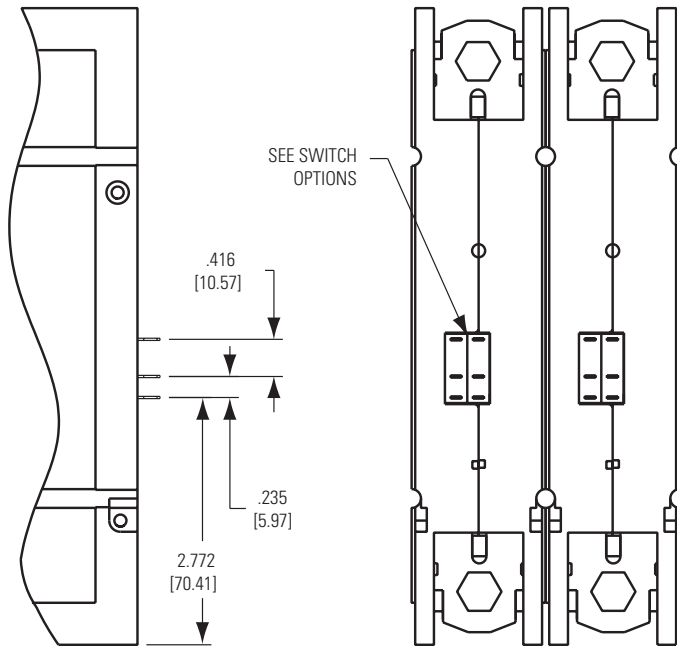

Relay Trip

This permits the overload sensing coil to be placed in a circuit which is electrically isolated from the trip contacts. The coil may be actuated by sensors monitoring pressure, flow, temperature, speed, etc. Other typical applications include crowbar, interlock and emergency rapid shut down circuitry. Trip may be accomplished by voltage or current, which must be removed after trip.

Shunt Trip

The shunt trip is designed for controlling two separate loads with one assembly. The control is established by providing overload protection for the critical load. When the current through this load becomes excessive and reaches the trip point, the protector will open and remove power from both loads simultaneously. The total current rating of both loads must not exceed the maximum contact rating.

Shunt Trip

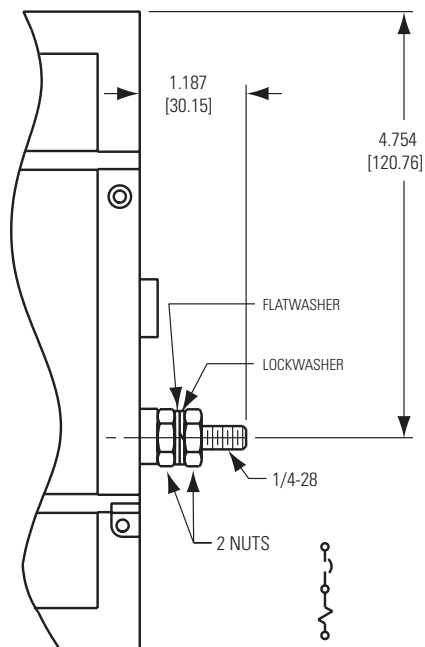

Relay Trip

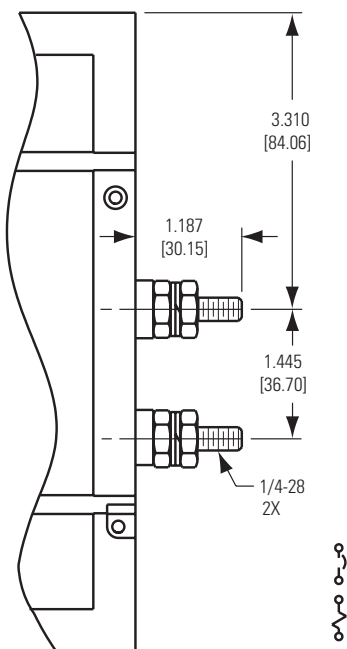

Metering Shunt

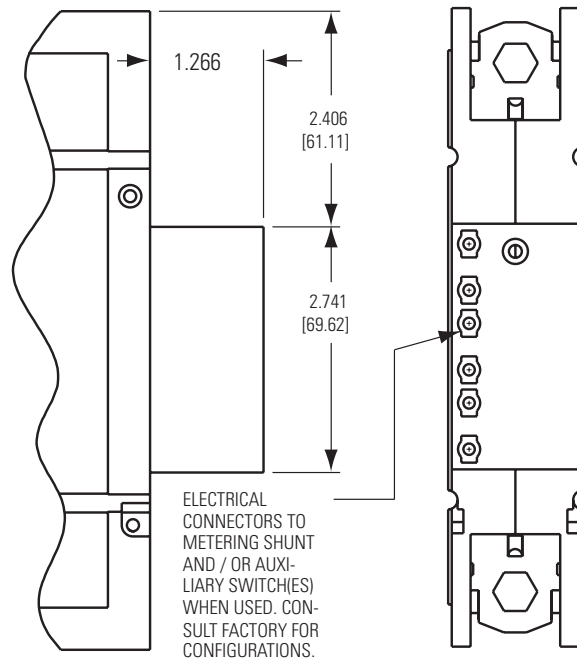

METERING SHUNT/AUXILIARY SWITCH CONNECTORS

| Description | MOLEX | AMP |
|-----------------|------------|----------|
| Pin (Male) | 02-09-2103 | 770147-1 |
| Socket (Female) | 02-09-1104 | 770146-1 |

OPERATING CHARACTERISTICS

Trip Free

Will trip open on overload, even when forcibly held on. This prevents the operator from damaging the circuit by holding the handle in the ON position.

Insulation Resistance

Will not be less than 100 megohms at 500 volts D.C.

Endurance

Test to be performed at rated current and rated voltage at 3mSec time constant DC. Rate of operation to be 5 operations per minute for breakers rated at 250 amps and less and 4 per minute for breakers rated above 250 amps. Breakers rated above 250 amps but 600 amps or less shall be rated for 1000 loaded operations and 5000 mechanical operations.

Auxiliary Switch

When supplied will be S.P.D.T. configuration with a maximum rating of 10 amperes 250 VAC 1 amp 80 Vdc. When optional metering shunt or parallel pole configuration is specified, maximum rating is 1 amp 80 Vdc.

High-Low Temperature

Circuit breakers will operate in the range from -40°C to +85°C. All agency testing is conducted with wire sized per 75°C chart of the National Electrical Code. In all cases the breaker connections should be sized to limit the maximum terminal temperature to 100°C absolute when the breaker is operating in the maximum ambient temperature at the maximum load current.

General notes for Agency Approvals

All supplementary protectors are of the overcurrent (OC) type

The family of protectors has been evaluated for end use application for use group (UG) A

The terminals (FW) – Terminals are coded as follows:

- 0 – Suitable for factory wiring only
- 1 – Line terminals evaluated for field wiring
- 2 – Load terminals evaluated for field wiring
- 3 – Line and load terminals evaluated for field wiring

The maximum voltage ratings for which the protectors have been tested are shown in the chart

The current is the amperage range that the protectors have been tested

The tripping current (TC) – Tripping current is coded as a percentage of the ampere rating

- 0 – Tripping current is less than 125% of ampere rating
- 1 – Tripping current is in the range of 125% to 135% of ampere rating
- 2 – Tripping current is more than 135% of ampere rating
- 3 – Tripping current is 135% and meets MCCB trip time requirements

The overload rating (OL) - designates whether the protector has been tested for general use or motor starting applications.

- 0 – tested at 1.5 times amp rating for general use
- 1 – tested at 6 times AC rating or 10 times DC rating for motor starting

The short circuit current rating (SC) – The short circuit rating in amperes following a letter and number designating the test conditions and any calibration following the short circuit test is defined below:

- C – Indicates short circuit test was conducted with series overcurrent protection
- U – Indicates short circuit test was conducted without series overcurrent protection
- 1 – Indicates a recalibration was not conducted as part of the short circuit testing
- 2 – Indicates a recalibration was performed as part of the short circuit testing
- 3 – Indicates recalibration was performed along with the dielectric and voltage withstand for “Suitable for Further Use” rating

Overload

DC rated circuit breakers will withstand 50 operations at 600% of rated current. The current shall have no less than a 3mSec time constant at rated voltage. Units to be operated in groups of five at the rate of operations per minute with fifteen minutes between groups to allow for cool down.

Dielectric Strength

Circuit Breaker will withstand 1000 volts plus twice rated voltage 60 Hz AC for 60 seconds from terminal to terminal.

Voltage Ratings

On all types, voltages up to and including 160 volts DC. Multi-pole units can be supplied for 125/250 volts Vdc. All units will be marked with the standard maximum voltage. UL listed breakers will be labeled with the UL listed voltage.

DC Applications (typ)

A choice of delays is offered for DC applications. Delay 51 is a short delay for general purpose applications. Delay 52 is long enough to start certain types of motors and most transformer and capacitor loads. Delay 53 is a long delay for special motor applications.

All trip curves and trip currents are specified with the breaker mounted in the normal vertical position at ambient temperature of +25°C. For test and measurement purposes, the breakers should not carry current prior to application of overload for calibration test. For other than vertical mount position, consult factory.

| JRE/JRM/JREP/JRMP SUPPLEMENTARY PROTECTORS - AGENCY APPROVALS | | | | | | | | | | | |
|--|----------------|----|------|-------|------------|----|----|-----------------------------|--------|-------------------------------------|-------------|
| Volts (Volts) | | | | | | | | Rated Current (Amps) | | Interrupting Capacity (Amps) | |
| Voltage (V) | Frequency (Hz) | UG | FW | Phase | Min. Poles | TC | OL | UL/CSA | VDE | UL 508 & CSA | VDE |
| 65 | DC | A | 0, 3 | — | 1 | 1 | 1 | 100-250 | — | U2, 100000 | — |
| 65 | DC | A | 0, 3 | — | 2 | 1 | 1 | 275-400 | — | U2, 100000 | — |
| 65 | DC | A | 0, 3 | — | 2 | 1 | 1 | 450 | — | U2, 100000 | — |
| 65 | DC | A | 0, 3 | — | 3 | 1 | 1 | 450-600 | — | U2, 100000 | — |
| 65 | DC | A | 0, 3 | — | 3 | 1 | 1 | 700 | — | U2, 65000 | — |
| 65 | DC | A | 0, 3 | — | 3 | 1 | 1 | 700 | — | U2, 100000 | — |
| 80 | DC | — | — | — | 1 | — | — | — | 15-250 | — | 10000/25000 |
| 160 | DC | A | 0, 3 | — | 1 | 1 | 1 | 100-250 | 15-250 | U2, 10000 | 5000/10000 |
| 160 | DC | A | 0, 3 | — | 2 | 1 | 1 | 251-400 | — | U2, 10000 | — |
| 160 | DC | A | 0, 3 | — | 3 | 1 | 1 | 401-600 | — | U2, 10000 | — |
| 160 | DC | A | 0, 3 | — | 3 | 1 | 1 | 700 | — | U2, 10000 | — |
| 277/480 | 50/60 | A | 0, 3 | 3 | 3 | 1 | 1 | 150 | — | U2, 5000 | — |

| JTE/JTM/JTEP/JTMP COMMUNICATIONS EQUIPMENT CIRCUIT BREAKERS - AGENCY APPROVALS | | | | | | | | |
|---|----------------|-------|------------|-----------------------------|-----------|---------|-------------------------------------|--|
| Volts (Volts) | | | | Rated Current (Amps) | | | Interrupting Capacity (Amps) | |
| Voltage (V) | Frequency (Hz) | Phase | Min. Poles | UL/CSA | VDE | UL 489A | VDE | |
| 65 | DC | — | 1 | 100 to 250 | — | 100000 | — | |
| 65 | DC | — | 2 | 275 to 400 | — | 100000 | — | |
| 65 | DC | — | 2 | 401 to 450 | — | 100000 | — | |
| 65 | DC | — | 3 | 450 to 600 | — | 100000 | — | |
| 65 | DC | — | 4 | 700 to 800 | — | 100000 | — | |
| 65 | DC | — | 5 | 900 to 1000 | — | 65000 | — | |
| 65 | DC | — | 6 | 1100 to 1200 | — | 65000 | — | |
| 80 | DC | — | 1 | — | 15 to 250 | — | 25000 | |
| 160 | DC | — | 1 | 100 to 250 | 15 to 250 | 10000 | 10000 | |
| 160 | DC | — | 2 | 251 to 400 | — | 10000 | — | |
| 160 | DC | — | 3 | 401 to 600 | — | 10000 | — | |
| 160 | DC | — | 4 | 700 to 800 | — | 10000 | — | |

| JLE/JLM - AGENCY APPROVALS | | | | | | | | |
|-----------------------------------|----------------|-------|------------|-----------------------------|----------|-------------|-------------------------------------|--|
| Volts (Volts) | | | | Rated Current (Amps) | | | Interrupting Capacity (Amps) | |
| Voltage (V) | Frequency (Hz) | Phase | Min. Poles | UL/CSA | VDE | UL489 & CSA | VDE | |
| 65 | DC | — | 1 | .10 - 250 | — | 100000 | — | |
| 80 | DC | — | 1 | — | 15 - 250 | — | 25000 | |
| 160 | DC | — | 1 | .10 - 250 | 15 - 250 | 10000 | 10000 | |
| 125/250 | DC | — | 2 | 100 - 250 | — | 10000 | — | |
| 240 | 50/60 | 1 | 1 | .10 - 250 | — | 10000 | — | |
| 240 | 50/60 | 1 & 3 | 2 | .10 - 250 | — | 18000 | — | |

OPERATING CHARACTERISTICS

| PERCENTAGE OF RATED CURRENT VS TRIP TIME IN SECONDS AT +25°C | | | | | | | | |
|--|---------|---------------|-----------|-----------|-----------|-------------|------------|--------------|
| Delay | 100% | 125% (Note A) | 150% | 200% | 400% | 600% | 800% | 1000% |
| 51 & 51F | No Trip | .5 to 10 | .25 to 3 | .15 to 9 | .05 to .3 | .015 to .15 | .01 to .09 | .01 to .04 |
| 52 & 52F | No Trip | 9 to 90 | 5 to 40 | 2 to 15 | .5 to 3 | .03 to 1 | .01 to .28 | .01 to .08 |
| 53 & 53F | No Trip | 100 to 1000 | 50 to 400 | 22 to 150 | 4 to 25 | .5 to 5 | .010 to 2 | .01 to .1 |
| 61 & 61F | No Trip | .4 to 10 | .25 to 3 | .13 to .9 | .03 to .2 | .015 to .15 | .01 to .09 | .008 to .045 |
| 62 & 62F | No Trip | 9 to 95 | 5 to 40 | 2 to 15 | .05 to 3 | .03 to 1 | .01 to .28 | .008 to .08 |
| 63 & 63F | No Trip | 100 to 1100 | 48 to 400 | 20 to 150 | 4 to 25 | .5 to 6 | .01 to 2 | .008 to .1 |

| NOMINAL DCR / IMPEDANCE | |
|-------------------------|-------------------|
| Current Ratings (Amps) | Resistance (ohms) |
| | DC Delays |
| | 51, 52, 53 |
| 100 | .000375 |
| 110 | .000375 |
| 125 | .000340 |
| 150 | .000325 |
| 175 | .000315 |
| 200 | .000225 |
| 225 | .000225 |
| 250 | .000225 |
| 400 | .000125 |
| 600 | .000083 |
| 800 | .000063 |
| 1,000 | .000050 |
| 1,200 | .000042 |

Notes:
Resistance is plus or minus 50%.

If a metering shunt option is provided it will add the shunts resistance to these values (i.e. A 400 Amp metering shunt would add (R=V/I). 0000625 Ohms of resistance to the non-metering shunt value of .000125 Ohms or .0001875 Ohms for a 400 Amp unit with a metering shunt).

DC resistance values are based on measurements by the voltmeter ammeter method. Rated current applied for one hour and at a voltage not less than 20 volts.

| RECOMMENDED TORQUE SPECIFICATIONS | |
|-----------------------------------|-----------------|
| Component | Torque (in-lbs) |
| 10-32 Mounting Inserts | 10 to 12 |
| M5 Mounting Inserts | 8 to 10 |
| 3/8-16 and M10 x 1.5 Captive Nuts | 220 to 230 |
| 3/8-16 and M10 x 1.5 Studs | 220 to 230 |
| Solderless Connectors | 180 |

| APPROXIMATE WEIGHT PER POLE | |
|-----------------------------|-------|
| Pounds | Grams |
| 2.25 | 1020 |

| INRUSH PULSE TOLERANCE | |
|------------------------|---------------------------------|
| Delay | Pulse Tolerance |
| 61, 62, 63 | 8 times rated current (approx) |
| 61F, 62F, 63F | 12 times rated current (approx) |

Inrush Pulse Tolerance

The table shown provides a comparison of inrush pulse tolerance with and without the inertial delay feature for each of the 50/60Hz delays. Pulse tolerance is defined as a single pulse of half sine wave peak current amplitude of 8 milliseconds duration that will not trip the circuit breaker.

DELAY CURVES

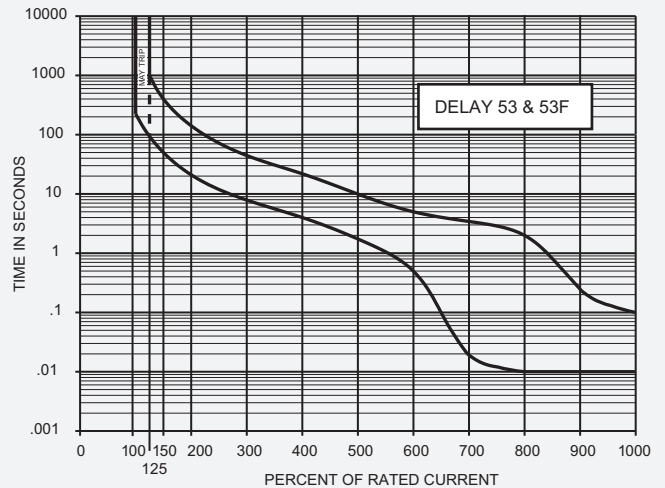
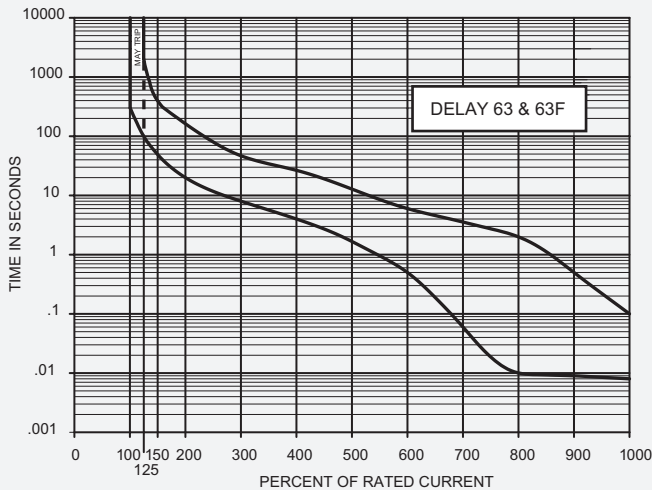
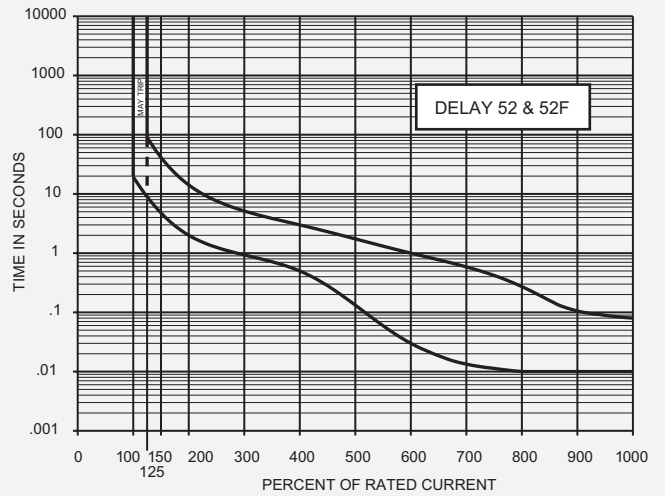
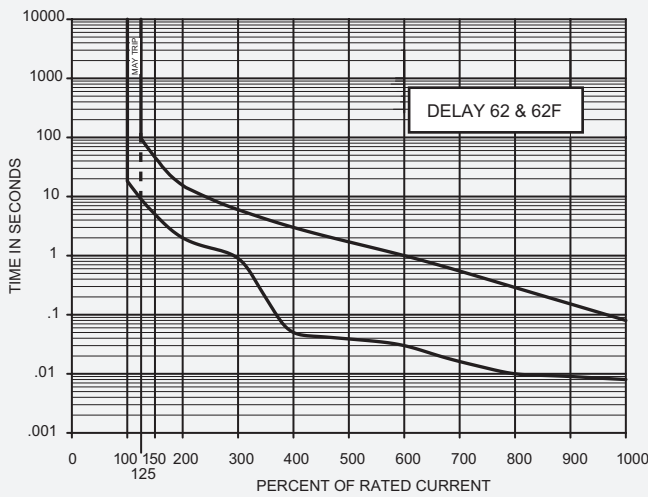
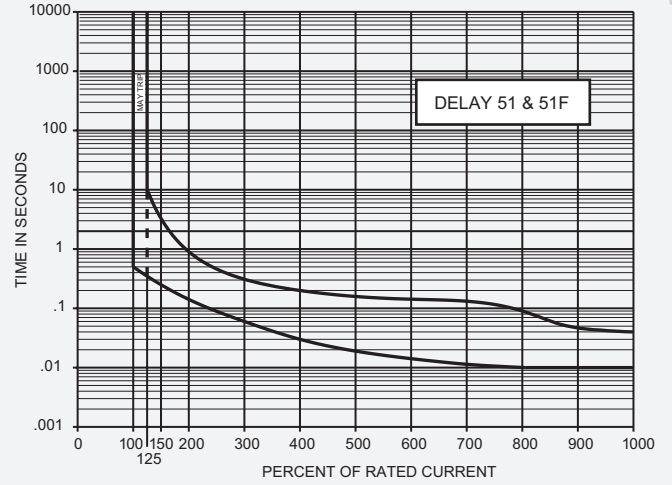
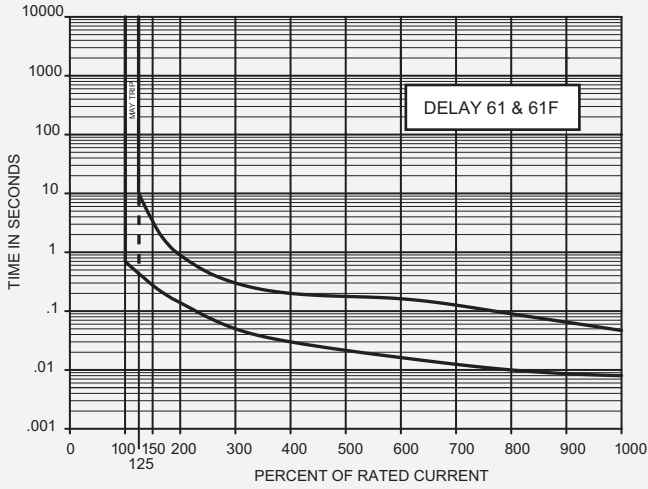

How to Order

The ordering code for JAE/JRE/JLE F-Frame Circuit Protectors may be determined by following the steps in the decision tables shown here.

The coding given permits a self-assigning part number for standard configurations. Factory part numbers are assigned to units with mixed ratings, combinations of styles or construction not listed in the Third Decision Table, etc. With these, it is suggested that order entry be by description and/or drawings, and a part number will be established.

Additionally, it is standard policy to establish a factory-assigned part number whenever a descriptive drawing exists to ensure cross reference, traceability and manufacturing control.

For example, the following is the code for a single pole breaker series trip, with mid-trip handle indication, auxiliary switch, short delay, 65 volts DC maximum voltage rating with 3/8-16 captive nuts in a current rating of 250 amperes and metric inserts.

To determine the ordering number of your particular JAE/JRE/JLE unit, simply follow the steps shown. You may use this number to place an order or as a reference for further questions you may have.

| 1 First Decision | |
|------------------|--|
| Type | |
| JLE | UL Listed |
| JLM | UL Listed MidTrip Construction |
| JRE | UL Recognized |
| JREP | UL Recognized above 250 amps |
| JRM | UL Recognized Mid Trip Construction |
| JRMP | UL Recognized Mid Trip Construction above 250 amps |
| JTE | UL Listed Telecom Specification |
| JTEP | UL Listed Telecom Specification above 250 amps |
| JTM | UL Listed Telecom Specification Mid Trip Construction |
| JTMP | UL Listed Telecom Specification Mid Trip Construction above 250 amps |
| JAE | Non Agency |
| JAEP | Non Agency above 250 amps |
| JAM | Non Agency Mid Trip Construction |
| JAMP | Non Agency Mid Trip Construction above 250 amps |

Notes:

- A 10-32 inserts are provided for front mounting on all units. M5 ISO metric mounting inserts are available and are specified by the eight decision in the part number.
- B The auxiliary switch is located on the left hand pole (viewed from terminal end) unless specified otherwise. Note this is the only location available for breakers rated over 250 amps. The switch is available as an alarm switch (changes state when breaker electrically trips) or as an auxiliary switch (changes state when the breaker contacts change state either from tripping or operation of the breaker handle). See outline drawing for location of alarm and auxiliary switches. Note alarm switches are available only with mid trip option. When both an alarm and auxiliary switch are specified with a metering shunt, only the C and NO or C and NC terminals from each switch are available for field termination.
- C 3/8-16 captive nuts are available for bus bar terminations or crimp lugs (specify front or back termination). 3/8-16 long and short studs are also available (specify front or back mount). A number 6 through 300 MCM AL/CU solderless connector is available (specify front or back mount).
- D Only series construction and DC ratings are available in current carrying poles above 250 amps. Consult factory for special requirements.

- E The coding given permits a self-assigning part number but with certain limitations, (due to the adaptability of magnetic protectors to complex circuits) which require a need for a factory assigned part number. Typical examples are units with mixed ratings, combinations of styles, or construction not listed in the third decision table, etc. With these, it is suggested that order entry be by description and/or drawings, and a part number will be established. Additionally, it is standard policy to establish a factory assigned part number wherever a descriptive drawing exists to provide cross-reference, traceability, and manufacturing control.
- F When specifying a protector for AC motor start or high inrush applications, the peak amplitude and surge duration should be specified for factory assistance in rating selection.
- G Since magnetic protectors with time delay are somewhat attitude and temperature sensitive, all trip curves and trip currents are specified with the protector mounted in the normal vertical position at ambient temperature of 25°C. Protectors do not carry current prior to application of overload for calibration test. For other than vertical mount position, consult factory.
- H A 25mV at rated current non-isolated metering shunt is available as an option (see outline drawing). The shunt accuracy is 1% full scale 25°C ambient.
- I Dual coil construction is available. Consult the factory.
- J Decisions referencing this note may be replaced by a factory assigned nondescript number.

2 Second Decision

Poles

| | |
|-----|-------------|
| -1* | Single pole |
| -2 | Two poles |
| -3 | Three poles |
| -4 | Four poles |
| -5 | Five poles |
| -6 | Six poles |

*Single pole unit above 250 Amps are supplied as parallel multi-pole assemblies. The second decision must indicate the physical number of poles.

4 Fourth Decision

Frequency and Delay

| Standard | | Option |
|----------|----------------------|--------|
| 50 | DC instant trip | |
| 51 | DC short delay | 51F |
| 52 | DC med. delay | 52F |
| 53 | DC long delay | 53F |
| 60 | 50/60Hz instant trip | |
| 61 | 50/60Hz short delay | 61F |
| 62 | 50/60Hz med. delay | 62F |
| 63 | 50/60Hz long delay | 63F |
| SW | Switch only | |

An F after any delay denotes high pulse tolerance construction.

6 Sixth Decision

Terminal Selection

| | Terminal | Terminal Connect |
|-----|--|------------------|
| -B0 | Solderless connector* | Back |
| -F0 | Solderless connector | Front |
| -B1 | 3/8 - 16 captive nuts | Back |
| -F1 | 3/8 - 16 captive nuts | Front |
| -B2 | .437 hole | - |
| -B3 | 3/8 - 16 stud terminals** | Back |
| -F3 | 3/8 - 16 stud terminals | Front |
| -B4 | 3/8 - 16 stud terminals long with spacers* | Back |

* Automatically get anti-flashover for multi-pole construction. Refer to outline drawings.
 ** Automatically get anti-flashover barrier for multi-pole construction with voltage ratings above 250 volts.

Example: **JLM -1 - IREC4 - 51- 1 - F1 - 250 - A - V**

1
2
3
4
5
6
7
8

3 Third Decision

Internal Configuration

| | |
|-------|---|
| -0 | Switch only |
| -1 | Series |
| -3 | Shunt construction*** |
| -4 | Relay construction*** |
| -REC4 | Auxiliary switch* (STD) .110 quick connect |
| -REG4 | Auxiliary switch* .110 quick connect** |
| -REC5 | Auxiliary switch* (STD) .187 quick connect |
| -RLS4 | Alarm switch* (STD) .110 quick connect |
| -RLS5 | Alarm switch* .187 quick connect |
| -DAA4 | Dual auxiliary & alarm switch* (STD) .110 quick connect |
| -DAA5 | Dual auxiliary & alarm switch* .187 quick connect |

* Auxiliary switch located in the left hand pole when viewed from the terminal end. All meter shunt and parallel pole builds that require an auxiliary switch will automatically get a XXX4 type switch. To connect to the switch terminals which are brought through the cover use a Molex 02-09-1104 or an Amp 770146-1 crimp terminal.
 ** Gold Contacts
 *** Shunt and Relay construction not available above 250 Amps and not available in UL Listed Breakers

5 Fifth Decision

Voltage and Current

| | Maximum Voltage | Maximum Current (Amps) |
|----|-----------------|------------------------|
| -1 | 65Vdc | 1200A |
| -2 | 125Vdc | 800A |
| -3 | 160Vdc | 800A |
| -4 | 125/250Vdc* | 250A |
| -5 | 240Vac | 250A |
| -6 | 277Vac | 250A |
| -7 | 277/480Vac | 150A Only |

*Two poles breaking

V = VDE and CCC Approved

Approval requires the addition of a V at the end of the part number, which denotes VDE and CCC approval. Consult the factory for availability.

C = CCC Approved

This approval requires the addition of a C at the end of the part number. The unit will not be VDE Approved.

7 Seventh Decision

Current Ratings (see note J)

| Amperes | Amperes |
|---------|---------|
| 100 | 450 |
| 125 | 500 |
| 150 | 550 |
| 175 | 600 |
| 200 | 700 |
| 225 | 800 |
| 250 | 900 |
| 275 | 1000 |
| 300 | 1100 |
| 350 | 1200 |
| 400 | |

8 Eighth Decision

Optional

| | |
|---|----------------------------|
| A | Optional metric inserts M5 |
| S | Optional metering shunt |

AIRPAX®

MDS2 Series Modular Distribution Systems

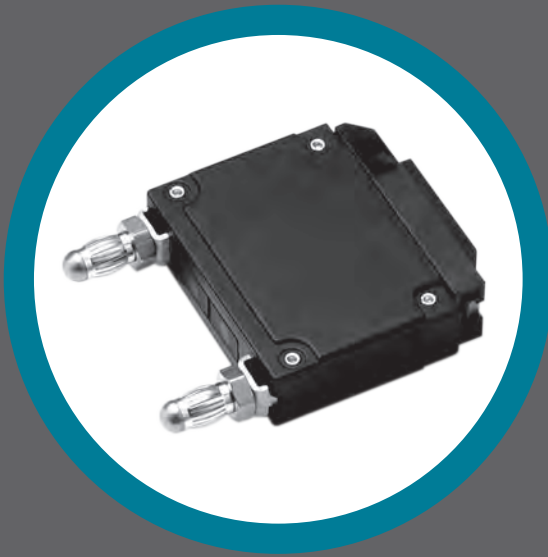

- Introduction* • 221
- 8-Position Configuration* • 222
- Decision Tables* • 223



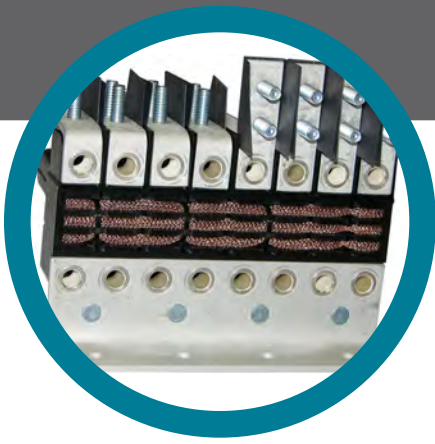

AIRPAX® | MDS2 Series

Modular Distribution Systems

INTRODUCTION

Sensata Technologies provides circuit-on-demand from a pre-wired power bus. The Airpax™ modular distribution system utilizes “plug ‘n play” capabilities to simplify the design of your power bus system.

The module design simplifies line/load interface, saving both money and valuable time by eliminating the need for shutdown when expanding the equipment. Additionally, this flexible

interface allows for adjacent circuits to be fused or protected, while parallel alarm conductors simplify signal wiring. By specifying the number of protected circuits, the MDS2 can be designed to meet your application requirements.

Sensata, known for our high quality products and outstanding customer service, once again sets the standard in innovative and precision technology with our new MDS2.

FEATURES & HIGHLIGHTS

- Lightweight, space-saving modular distribution system specifically designed for flexibility in DC power distribution
- Building-block concept allows users the flexibility to specify units in blocks of 2 positions up to 24 positions
- Modules allow for equipment expansion without power shutdown
- Mounts horizontally or vertically directly to the bus bar or mounting rail
- Unique alarm conductors simplify signal wiring
- Modular load terminals available with front or rear access

SPECIFICATIONS

| | |
|--|--|
| Application | For use with Airpax™ IEL, IML, LEL and LML type circuit protectors and breakers using 5/16 inch diameter bullet terminals |
| Electrical Ratings | 100 amperes max. load bus rating per position max. common bus of the 8 position system is 600 amperes. Voltage rating is 125 vdc |
| Flammability | All modular distribution system parts have UL 94 V0 flammability rating |
| Insulation Resistance | Min. 100 megohms @ 500 vdc |
| High-Low Temperature Operation | -40°C to +85°C |
| Dielectric Strength | 2000 VDC |
| Recommended Torque Specifications | Load bus 1/4-20 UNC: 40 to 45 inch pounds Load bus m6 x 1.0: 4 to 5 Nm Mechanical support must be provided to terminals while applying torque. |
| Auxiliary Switch Wire | 18 awg (ul 1213) |
| Ampacity | Line bus 600 amperes: 800 amps/sq. inch Load bus 100 amperes: 1250 amps/sq. inch |

EIGHT-POSITION REAR CONNECT

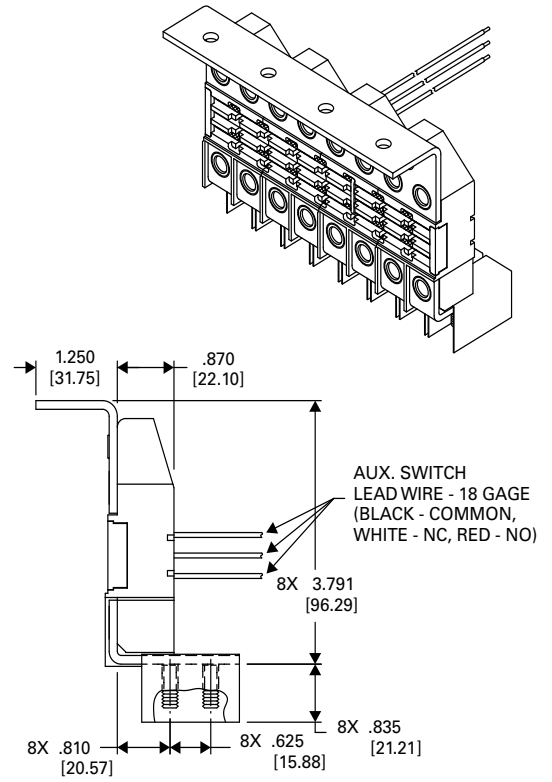
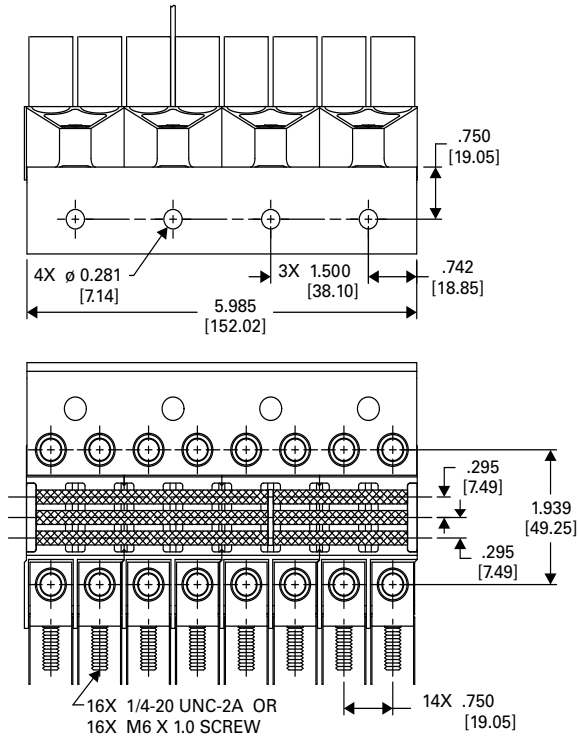

EIGHT-POSITION FRONT CONNECT

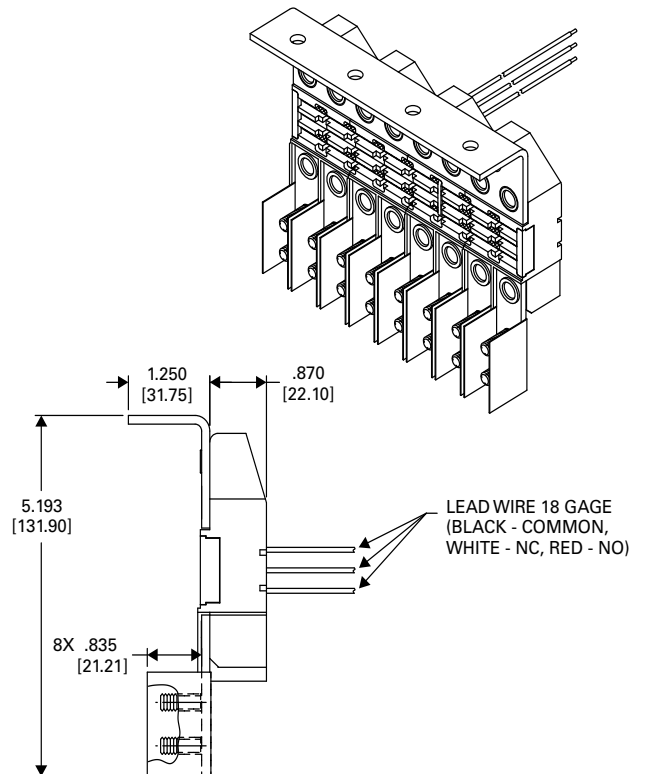
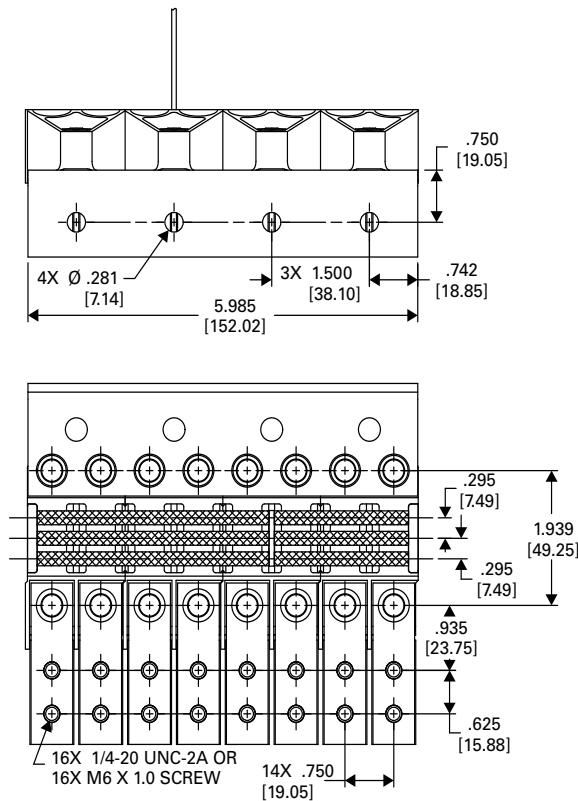

DECISION TABLES

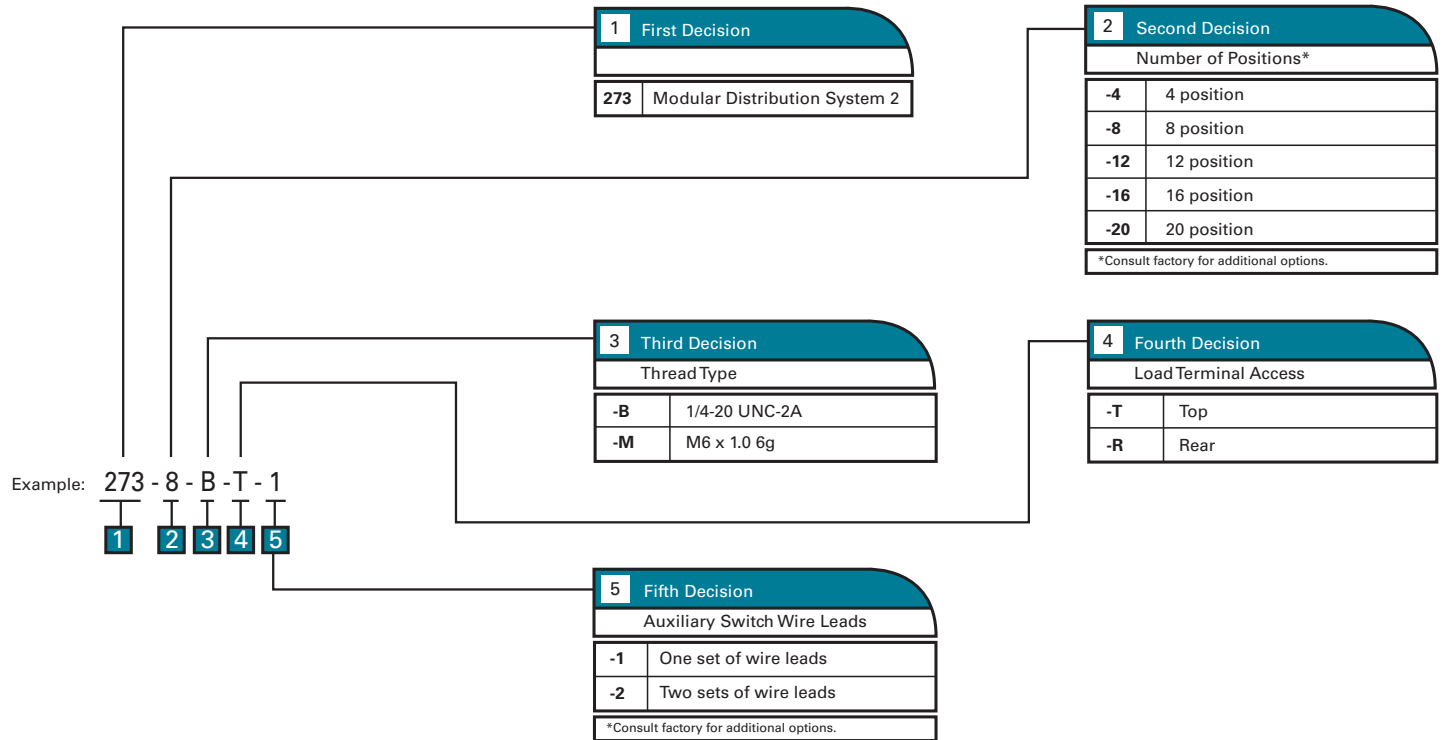

Notes:

- This specification covers Airpax four and eight position Modular Distribution Systems for LEL, LML, IEL, IML type circuit protectors using 5/16 inch diameter bullet terminals.
- High-Low Temperature Operation: The Modular Distribution System shall operate in a range from -40°C to +85°C.
- Dielectric Strength: The Modular Distribution System shall withstand DC voltage for 60 seconds between all electrically isolated parts as follows:
Between line and load bus bars: Minimum 2000 VDC
Between line and load bus bars and aux. switch contact strips: Minimum 2000 VDC
Between line and load bus bars and clamp up rods: Minimum 2000 VDC
- Insulation Resistance: Shall not be less than 100 megohms at 500 volts DC.
- Flammability: All Modular Distribution System parts have an U.L. 94 V-0 flammability rating.
- Electrical Ratings:
Current Ratings:
Maximum load bus rating per position is 100 amps.
Maximum common bus rating of the eight position Modular Distribution system is 600 amps.
Maximum common bus rating of the four position Modular Distribution System is 300 amps.
Voltage Rating: 125 VDC max.
- Recommended Torque Specifications:
Load bus 1/4 - 20 UNC 72 inch pounds
Line bus 3/8 - 16 UNC 192 inch pounds
Mounting channel #10 x 0.750 long 20 inch pounds
- Auxiliary Switch Wire Rating:
200° C; 600 volts; UL recognized (UL 1199)
- Ampacity:
Line bus @ 600 amps: 850 amps/sq inch
Line bus @ 300 amps: 850 amps/sq inch
Load bus @ 100 amps: 1140 amps/sq inch
- Plating: Common and load bus bars are available with either silver or tin plating.
Silver Plating: The plating of the louvertec bands of the Airpax circuit breakers used in the Modular distribution System are silver plated. Silver plated bus bars on the Airpax Modular Distribution System product significantly reduce the possibility of galvanic corrosion.
Tin Plating: The use of tin plated bus bars with the silver plated louvertec bands on the circuit breaker increases the possibility of galvanic corrosion at the joint interface.
The use of a conductive polymer such as Stabilant 22 or CAIG 100 is recommended with both silver plated and tin plated bus bars in order to negate galvanic corrosion and to improve the conductivity of the joint interface.
- Beryllium Copper Contact Strip: Beryllium copper strips are used to conduct current to and from the terminals of the circuit breaker auxiliary switch. The beryllium copper strips have a minimum compression set and will return to their original size with as much as a 30% deflection. Repeated insertion and removal of the circuit breaker in this application will have an insignificant effect on the contact force between the auxiliary switch terminals and the beryllium copper strips.



Ground Fault Sensing & Protection

GFCI/ELCI/Circuit Breakers



PGFM Series

- GFCI Sensing Module* • 225
- ELCI Sensing Module* • 227

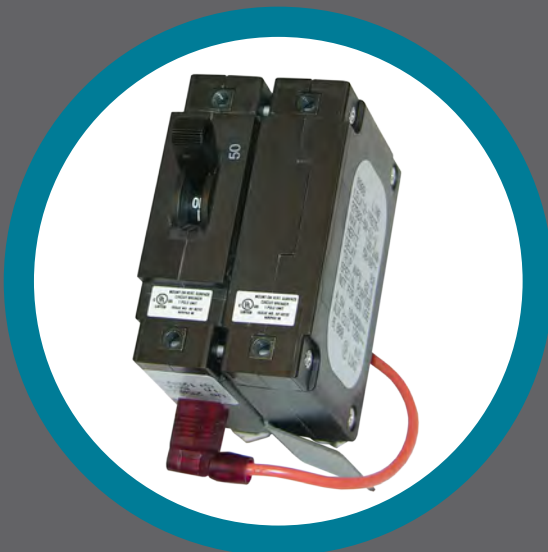



LineGard | PGFM Series

GFCI Ground Fault Protection Sensing Module

INTRODUCTION

The LineGard™ PGFM GFCI Sensing Module is a ground fault or equipment leakage sensing device designed and manufactured by North Shore Safety, a leader in innovative safety products. The PGFM operates in tandem with an approved Airpax LEL Series, UL 489 listed circuit breaker, with shunt trip and auxiliary switch.

The **combined assembly** is recognized as a Class A UL 943 rated device. The sensing module is available in models to operate at supply voltages of 120 VAC or 240VAC and can monitor single and split phase circuits.

These devices meet the requirements of OSHA 29 CFR 1926.404 (b)(1)(ii) and OSHA 29 CFR 1926.405 (a) (2)(ii)(G).



Airpax™ LEL series

FEATURES

- Power and fault status indicators
- Provides identification of a ground fault vs. short circuit trip
- Chemical and UV resistant enclosure
- Trip level of sensing device 5mA ± 1mA Class A UL 943
- Sensing module operates at 120VAC or 240VAC, single phase
- Unit operating temperature is -35°C to +66°C
- Accommodates up to 2 wires, 10 AWG, twisting of the wires is required

SPECIFICATIONS

| | |
|---------------------------------------|---|
| Type | E-11 GFP - UL 943 Category FTTJ2 when used in tandem with Airpax LEL series UL 489 listed circuit breaker with shunt trip |
| Operating Voltage | 120 VAC or 120/240 VAC |
| Interrupting Voltage | Rating of UL 489 listed circuit breaker |
| Sensing Coil Voltage Limit | 600 VAC maximum |
| Phase Interrupt | Single (120 VAC 3 wire) and Split (120/240 VAC 4 wire) |
| Interrupting Current | Rating of UL 489 listed circuit breaker |
| Trip Time of Combined Assembly | 100mS or less (60mS nominal) |
| Trip Level | 5mA +/- 1mA |
| Frequency | 50/60 Hz |
| Operating Temperature | -35°C to +66°C |
| Reset Type | Automatic on power up |

Note: 1. Manual configuration should be specified if automatic start-up after power restoration of circuit power creates an unsafe condition.
 2. As per UL 943 requirements, portable devices may require breaking of neutral during ground fault detection. Please contact the factory.
 3. Please contact Airpax for optional ELCI, UL 1053 compliant devices.

DIMENSIONS

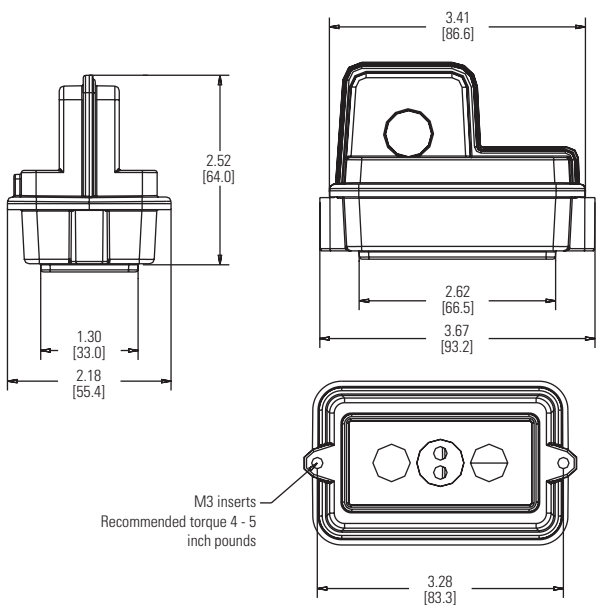

CIRCUIT SCHEMATIC (EXAMPLES)

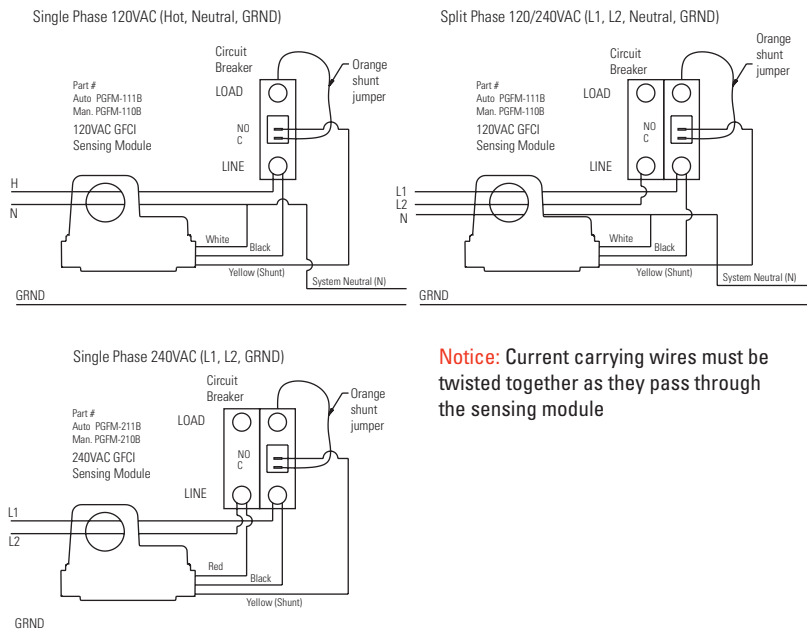

Notice: Current carrying wires must be twisted together as they pass through the sensing module

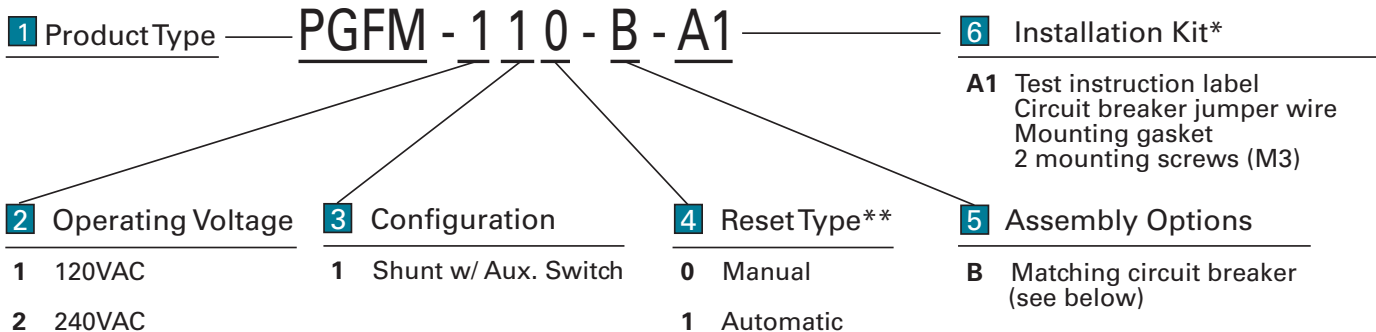

To determine a matching circuit breaker for use in tandem with the LineGard™ Sensing Module, please contact us directly or your local Sensata Representative for assistance with the appropriate identifying part number.





LineGard | PGFM Series (ELCI, Marine)

ELCI Marine Ground Fault Protection Sensing Module

INTRODUCTION

The LineGard™ PGFM product family provides ELCI (equipment leakage) ground fault sensing and is designed and manufactured by North Shore Safety, a leader in innovative safety products. The PGFM series operates in tandem with an Airpax™ LEL series, UL 489 listed circuit breaker, with shunt trip and auxiliary switch manufactured by Sensata Technologies. The PGFM can be paired with an Airpax™ IDLNK breaker for applications requiring ignition protection.

The **combined assembly** of the PGFM and an Airpax™ breaker meets the requirements of ABYC E-11 for ground fault protection and main shore power circuit protection. The PGFM constantly monitors the current balance of the conductors (wires / cables) supplying power to the load. When a ground fault of 27mA nominal (30 mA max) occurs, the PGFM uses the LEL's shunt trip coil to signal the breaker to trip.



Airpax™ LEL series

FEATURES

- Power and fault status indicators
- Provides identification of a ground fault vs. short circuit trip
- Chemical and UV resistant enclosure
- Trip level of sensing device < 30mA (27mA nominal) at trip time of < 100mS (60mS nominal) per E-11
- Protection range and operating voltage: 0 - 50 Amps, 120 VAC, 120/240 VAC
- Unit operating temperature is -35°C to +66°C
- Accommodates up to 3 wires, 6 AWG, with no twisting of the wires required

SPECIFICATIONS

| | |
|---------------------------------------|---|
| Type | E-11 GFP - UL 943 Category FTTJ2 when used in tandem with Airpax LEL series (UL 489 listed circuit breaker with shunt trip) |
| Operating Voltage | 120 VAC or 120/240 VAC, 50/60 Hz |
| Interrupting Voltage | Rating of UL 489 listed circuit breaker |
| Sensing Coil Voltage Limit | 600 VAC maximum |
| Phase Interrupt | Single (120 VAC 3 wire), Split (120/240 VAC 4 wire) , 240VAC 3-wire (L1, L2, N) |
| Interrupting Current | 120VAC, 50A, 5kAIC 120/240VAC, 50A, 5kAIC |
| Trip Time of Combined Assembly | 100mS or less (60mS nominal) |
| Trip Level | 27mA +/- 2mA |
| Operating Temperature | -35°C to +66°C |
| Reset Type | Automatic on power up |
| ABYC E-11 Acceptability | The LineGard™ PGFM ELCI module used in tandem with the Airpax™ circuit breaker meets the requirements of the ABYC (American Boat and Yacht Council) E-11 standard covering AC and DC systems on boats |

AIRPAX™ LEL & IDLNK SERIES CIRCUIT BREAKER RATINGS (PER UL489)

| Voltage | Current | Frequency | Short Circuit | Poles |
|----------------|-----------------|------------------|----------------------|--------------|
| 125VAC | 0.05 to 50 amps | 50/60 Hz | 5,000 amps | 1 to 3 |
| 120/240VAC | .05 to 50 amps | 50/60 Hz | 5,000 amps | 2 to 3 |

AIRPAX™ LEL & IDLNK SERIES CIRCUIT BREAKER SPECIFICATIONS

| | |
|-------------------------------|---|
| Moisture Resistance | MIL-STD-202, Method 106 |
| Salt Spray (Corrosion) | MIL-STD-202, Method 101 |
| Shock | MIL-STD-202, Method 213, Test Condition I with 100% rated current applied |
| Vibration | MIL-STD-202, Method 204, Test Condition A with 100% rated current applied |
| LEL Agency Approvals | UL489 Listed, CSA Certified, VDE Approved, CCC Approved, CE Compliant |
| IDLNK Agency Approvals | UL 1077 Recognized, C22.2 No. 235 complaint to UL 1500 or SAE J1171 ignition protection |

LINEGARD™ PGFM SERIES ELCI SPECIFICATIONS

| | |
|-----------------------------|--|
| Salt Fog (Corrosion) | ASTM B117 |
| Shock | 33CFR183.534 - modified to supply 5,000 shocks @ 25G, instead of test standard of 1,000 shocks |
| Vibration | MIL-STD-810 (random vibrate 4G RMS), IEC 6945 (sine sweep 5 to 100 Hz for low frequency) |
| Ignition Protection | SAE J1171 (UL1500) |

WIRING DIAGRAM (120VAC APPLICATION)

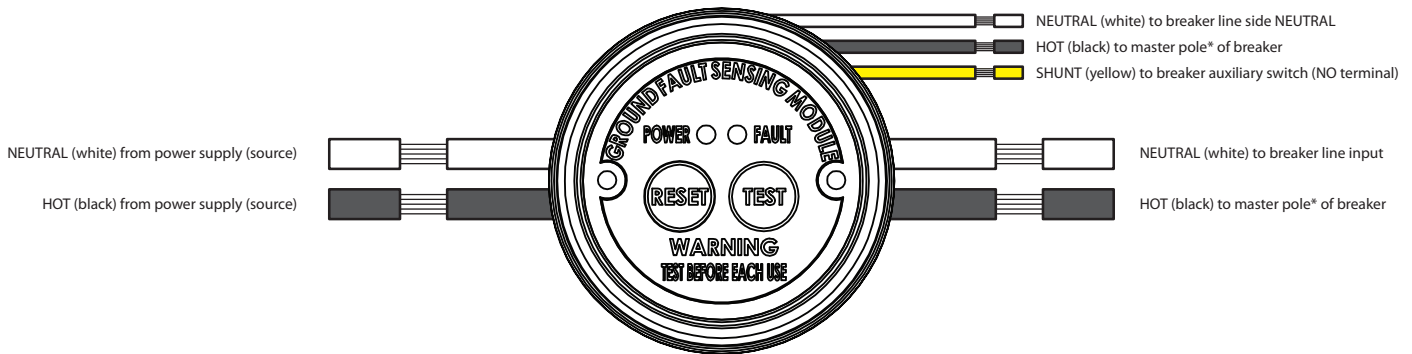

WIRING DIAGRAM (240 VAC APPLICATION)

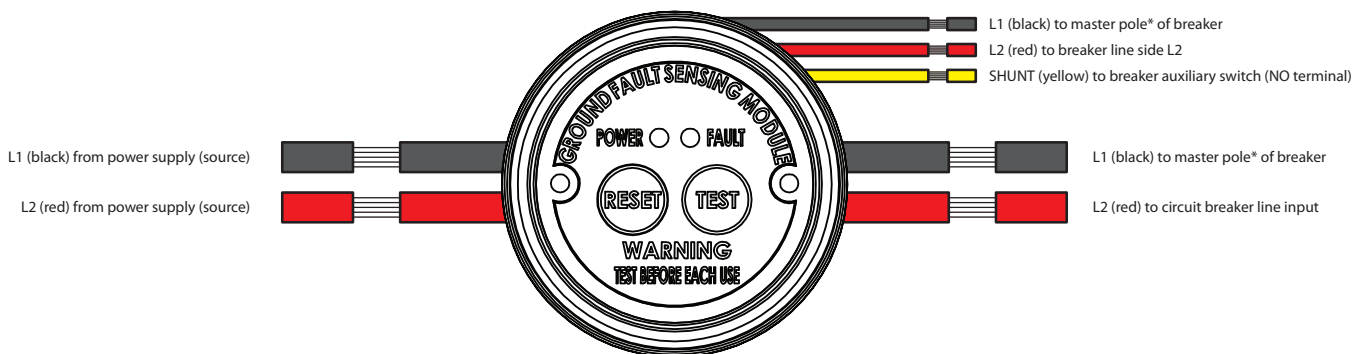

WIRING DIAGRAM (120/240 VAC APPLICATION)

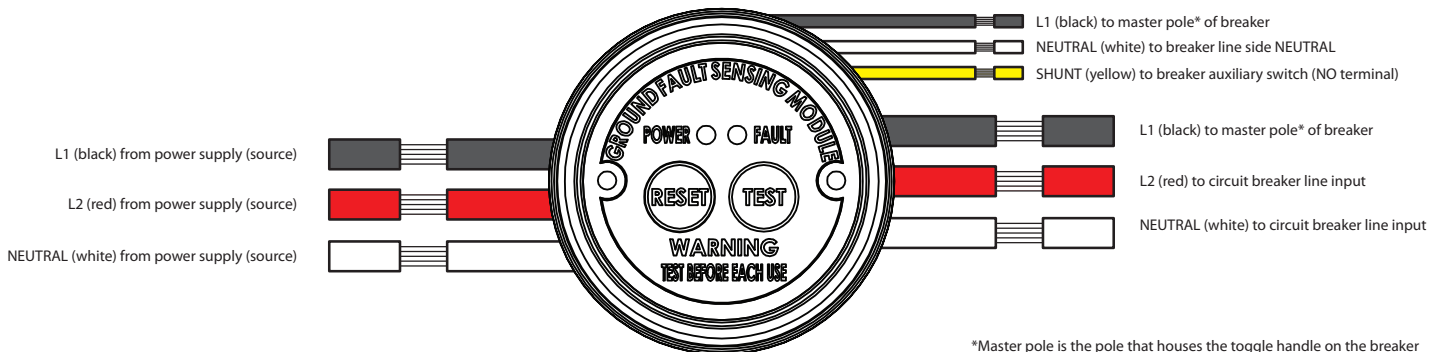

*Master pole is the pole that houses the toggle handle on the breaker

WIRING DIAGRAM (ORANGE JUMPER WIRE FOR CIRCUIT BREAKER)

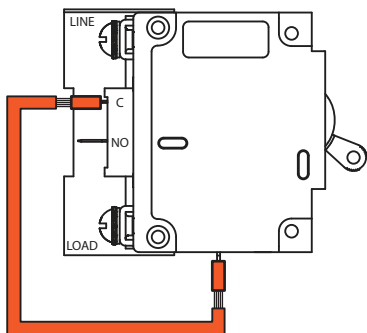

DANGER!

Hazard of electrical shock, burn or explosion. Disconnect power at main power feed before you start installation. Failure to do so may cause severe shock, personal injury, or death.

INSTALLATION INSTRUCTIONS

1. Read and follow all instructions
2. Identify all the features and wires (see drawings)
3. Identify line wires and load wires
4. Verify that the ratings on the device, including the circuit breaker, match your field line ratings
5. Strip wires to 5/8", or as recommended for your connections (module may include field terminations)
6. Choose the right wiring application (120VAC or 120/240VAC split phase) and connect wires according to diagrams
7. Place supplied test instruction label in close proximity to the ground fault sensing module mounting location.

NOTE: The ground wire should be connected externally. The Ground wire does not enter or exit the ground fault sensing module. Although the PGFM does not monitor ground leads or require ground to operate, ground connection is recommended and should be made at junction box.

TESTING AND TROUBLESHOOTING

In the normal operating state, the PGFM green LED is "ON" and circuit breaker is in the "ON" position.

1. Press "TEST" button: Green LED should go "OFF" and red LED should come "ON" and circuit breaker should trigger to "OFF" position
2. If sensing device red LED does not illuminate or breaker does not trip or change state, DO NOT USE and consult an electrician for assistance
3. Press "RESET" button: Red LED should turn "OFF" and green LED should turn "ON"
4. Manually reset (switch) the circuit breaker to the "ON" position to restore circuit power

WARNING: If the test fails, do not use this ELCI. Consult a qualified electrician for repair or replacement.

DIMENSIONAL DRAWINGS (PGFM MARINE)

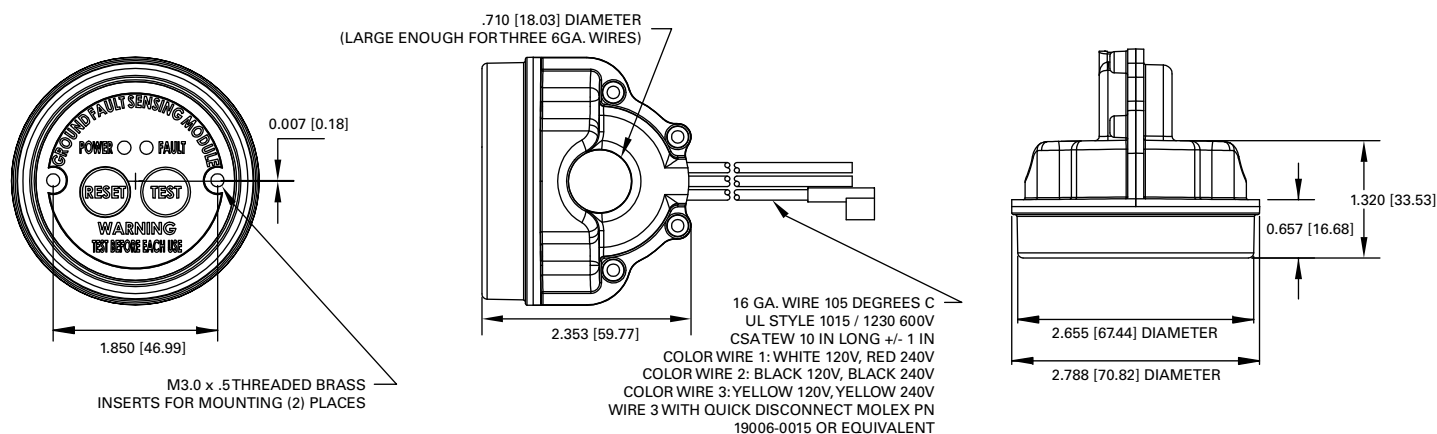

DIMENSIONAL DRAWINGS (EXAMPLE OF LEL, TYPICAL 2-POLE CONFIGURATION)

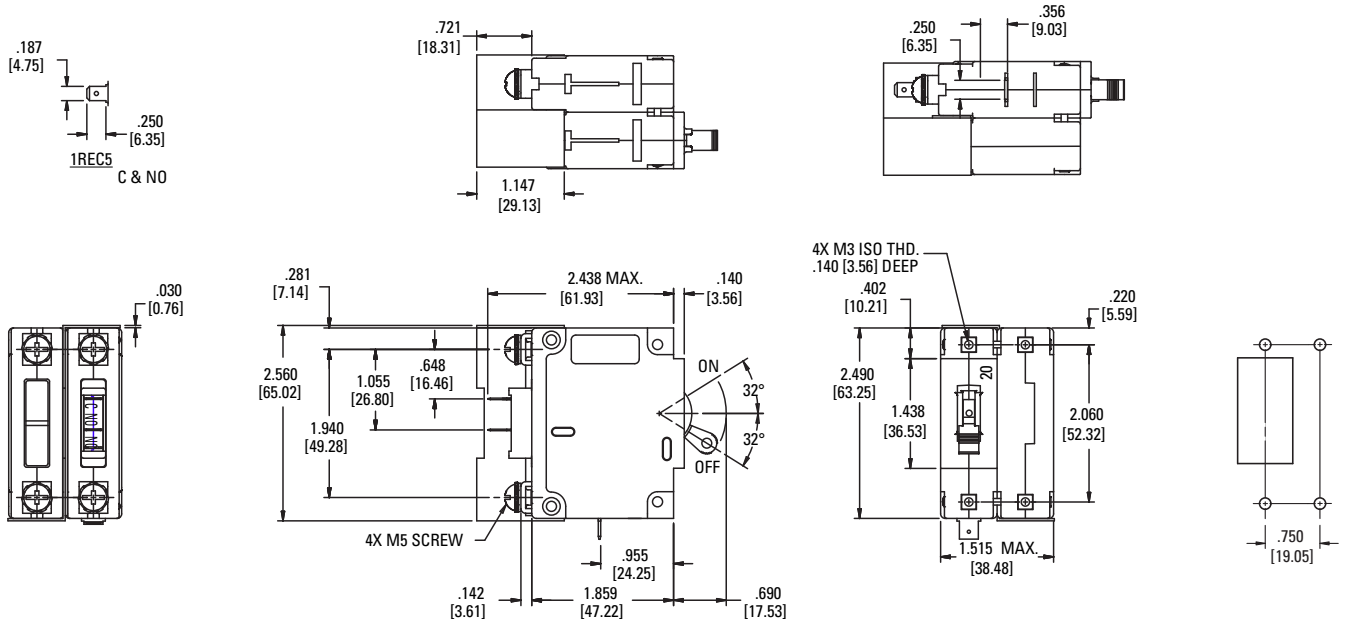

Panel Mounting Detail
Tolerance $\pm .005$ [.13] unless noted.

COMPATIBLE AIRPAX™ CIRCUIT BREAKERS - UL 489 LISTED; VDE PER EN 60934 (NON-IGNITION PROTECTED)

| Amps | Poles | Part Number | Voltage | Trip Coil | Short Circuit | Delay Curve |
|------|-------|-----------------------------|----------|-----------|---------------|-------------|
| 30 | 2 | LEL12-1REC5-37583-30-G1-V | 120V | 120V | 5000A | |
| 30 | 2 | LEL12-1REC5-37583-30-G2-V | 240V | 240V | 5000A | |
| 30 | 3 | LEL121-1REC5-37275-30-G1-V | 120/240V | 120V | 5000A | |
| 50 | 2 | LELK12-1REC5-37583-50-G1-V | 120V | 120V | 5000A | |
| 50 | 2 | LELK12-1REC5-37583-50-G2-V | 240V | 240V | 5000A | |
| 50 | 3 | LELK121-1REC5-37275-50-G1-V | 120/240V | 120V | 5000A | |

DIMENSIONAL DRAWINGS (EXAMPLE OF IDLNK, TYPICAL 2-POLE CONFIGURATION)

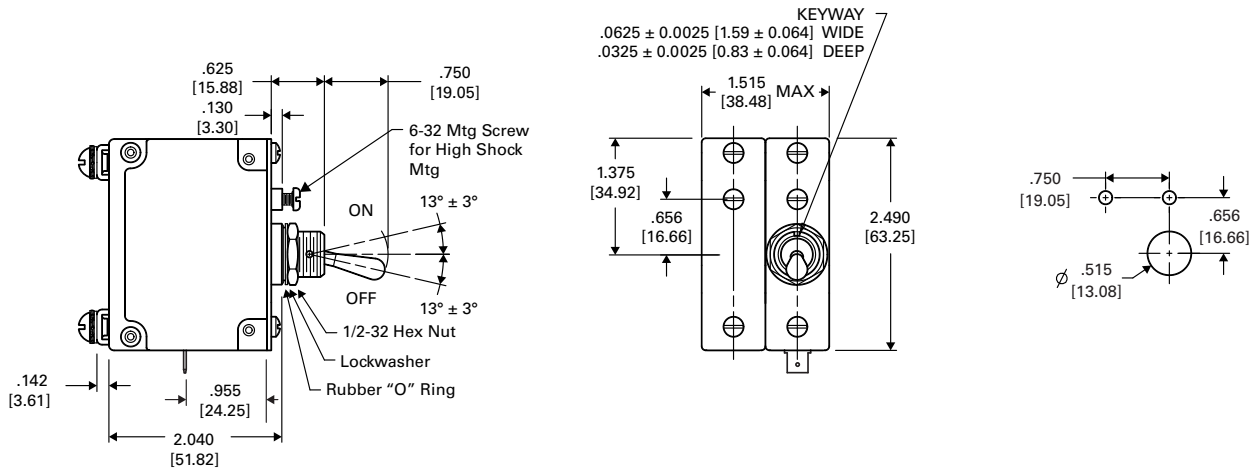

Panel Mounting Detail
Tolerance $\pm .005$ [.13] unless noted.

| COMPATIBLE AIRPAX™ CIRCUIT BREAKERS - UL 1077 RECOGNIZED; IGNITION PROTECTED PER SAE J1171 (UL 1500) | | | | | | Delay Curve |
|--|-------|----------------------------|----------|-----------|---------------|-------------|
| Amps | Poles | Part Number | Voltage | Trip Coil | Short Circuit | |
| 30 | 2 | IDLNK21-1REC5-38140-30-G1 | 120V | 120V | 5000A | |
| 30 | 2 | IDLNK21-1REC5-38140-30-G2 | 240V | 240V | 5000A | |
| 30 | 3 | IDLNK121-1REC5-39945-30-G1 | 120/240V | 120V | 5000A | |
| 50 | 2 | IDLNK21-1REC5-38140-50-G1 | 120V | 120V | 5000A | |
| 50 | 2 | IDLNK21-1REC5-38140-50-G2 | 240V | 240V | 5000A | |
| 50 | 3 | IDLNK121-1REC5-39945-50-G1 | 120/240V | 120V | 5000A | |

DECISION TABLES (PGFM Series)

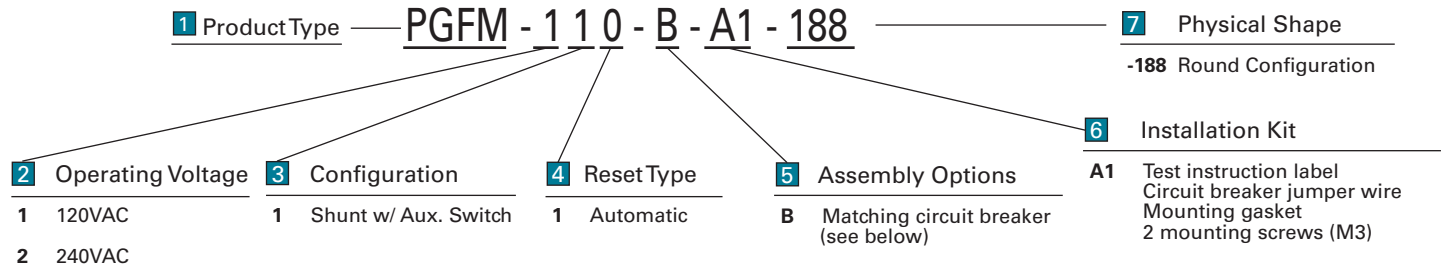

AIRPAX®

Glossary Terms & Definitions

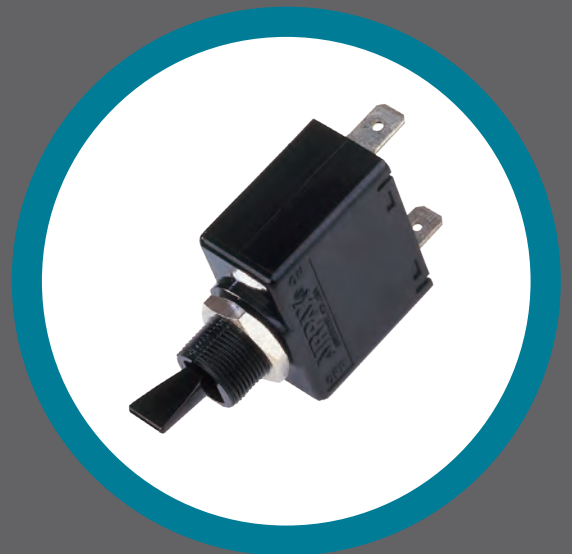

Ambient Temperature: Temperature of medium, such as air, water or earth, into which heat of device is dissipated.

Ampacity: Current-carrying capacity of electrical conductor or device.

Arcing Time: (As used for fuses) is measured from point when element melt time ends to point when current is interrupted and permanently becomes zero. If mechanical indicator is used which incorporates secondary element parallel to fusible equipment, arcing time will commence from point at which indicator melt time ends. Circuit breaker arcing time is measured from the moment of contact separation to the point when the current permanently drops to zero.

Automatic: Self-acting, operating by own mechanism when actuated by some impersonal influence, such as change in current strength, pressure, temperature or mechanical configuration.

Branch Circuit: Portion of wiring system extending beyond final over-current device protecting circuit.

Busbars: Current-carrying conductors in power distribution equipment, such as unit substations, busways, etc. Usually solid copper and rectangular shaped rather than round.

Cascade Circuit: Circuit in which more than one protector is connected in series between power source and load. (See Coordination.)

Circuit Breaker: Device used to open and close circuit by non-automatic means, as well as to open circuit automatically on predetermined overload current without injury to itself (when properly applied within its rating.)

Circuit Breaker, Non-Trip-Free: Breaker designed so that circuit can be held closed by restraining handle when carrying overload current that would normally trip breaker to open position (Not normally recommended.)

Circuit Breaker Trip-Free: Breaker whose pole(s) cannot be maintained closed when carrying over-load currents that would automatically trip breaker to open position. None of the circuit breaker poles would reclose while operating mechanism is maintained in closed position.

Common Trip: Multi-pole circuit breaker in which overload on any pole will cause all poles to open simultaneously.

Conductor: Material that has attached to its atoms many "free" electrons which may be detached easily by electrical pressure or voltage. Silver, copper and aluminum are good conductors. Thus any material or wire that is used to carry electric current.

Coordination: Ability of protector with lowest rating (in cascade arrangement) to open before protectors with higher rating when fault occurs downstream from lowest rated protector. (See Cascade Circuit.)

Current Limitation: Ability of protective device to reduce short-circuit peak current to value less than that which would be available if no protective device was in circuit.

Current Rating (Continuous): Maximum direct current or alternating current in amperes at rated frequency which protective device will carry continuously under defined conditions without exceeding specified performance limits.

Current-responsive Element (Fusible Elements): Part of fuse or limiter which carries current and melts when current exceeds predetermine value.

Disconnect: Device through which conductors of circuit can be disconnected from their source.

Duty Continuous: Requirement of service that demands operation at substantially constant load for an indefinitely long time.

Duty Intermittent: Requirement of service that demands operation for alternate intervals of (1) load and no load; or (2) load and rest; or (3) load, no load and rest.

Effective Voltage (or Current): Effective value of sinusoidal voltage or current is 0.707 times peak value. Also designated RMS value (Root Mean Square). When AC voltage is referred to effective value is understood unless otherwise noted. Symbols E and I without subscripts indicate effective values.

Element Melt Time: Time elapsed from moment fusing current begins to flow until moment current sharply drops in value and arcing commences.

Fault: Abnormal flow of current through defect in normal circuit configuration. Commonly referred to as short circuit.

Feeder: Circuit conductors between service entrance equipment and branch circuit overcurrent device.

Fuse: Device which protects circuit by melting of its current responsive element when overcurrent passes through it.

Fuse Dual Element: Time-delay fuse combines thermally controlled element which functions in case of overload and fusible element which operates under short circuit.

Fuse Normal Opening (Fast-acting): Opens circuit without deliberate time-delay.

Fuse Time-delay: Fuse that has its total clearing time deliberately delayed in overload current range.

Fuse Very Fast-acting: Fuse that opens circuit without deliberate time delay and whose short-circuit opening time is faster than normal opening fuse.

Instantaneous Trip (Opening): "Instantaneous" indicates delay is not introduced purposely into action of device.

Insulator (or Dielectric): Material that is very poor conductor of electricity. Mica, glass, porcelain, rubber, paper, plastic, oils and varnishes are considered good insulators.

Interrupting Capacity: Maximum short-circuit current at rated voltage which protective device is required to interrupt under operating duty specified and with normal frequency recovery voltage not less than rated voltage. (See Rupture Capacity.)

Kilowatthour (KWH): Electrical energy expended if 1 kilowatt is used for 1 hour.

Let-through Current: Current that actually passes through protective device after initiation of fault.

Minimum Fusing Current: Smallest value of current that will melt current responsive element at specified ambient temperature.

Overcurrent: Any current exceeding rated current of protective device (exceeding maximum ultimate trip current for circuit breakers.) This includes both overload and short-circuit currents.

Overload Current: Overcurrent in excess of current rating. Overload range is considered to be greater than rated current up to approximately ten times rated current.

Panelboard: Single group of assembled panels which include fuses. Assembled with or without switches and/or automatic overcurrent protective devices for control of light, heat or power circuits of small individual and aggregate capacity. Usually placed in or against wall or partition and accessible only from front.

Phase-to-phase: Voltage measured between any two "corners" of delta connection or between any two "legs" of wye connection.

Protective Device: Devices which respond to harmful abnormal conditions in electric distribution system and function to open parts of circuit which will isolate cause of disturbances and so permit remainder of system to function normally.

Recovery Voltage: Voltage impressed across protective device after circuit has been interrupted and after high frequency transients have subsided.

Rupture Capacity: Applied to reusable protective devices. (See Interrupting Capacity.)

Selective System: System in which protective device closest to faulted circuit opens and isolates that circuit without disturbing remainder of system. (See Coordination.)

Short-circuit Current (Fault Current): Maximum current that system can produce at point of application of protective device.

Time-delay: Qualifying term indicating that there is introduced purposely delayed action.

Time-inverse: Time-current relationship where protective device opening time decreases as current increases.

Total Clearing Time: Time measured from beginning of specified overcurrent condition until permanent interruption of circuit. Total clearing time for fuse or limiter is equal to sum of melting time and arcing time.

Ultimate Trip Current: Minimum current which will provide a reliable trip on the breaker (typically 115 percent of rated current.)

Voltage Drop: Fall of voltage along conductor due to its resistance.

Voltage Drop (Distribution System): Difference at any instant between voltages at source and utilization ends of feeder, branch circuit or transformer.

Voltage Rating: Maximum alternating current and/or direct current voltage at which protective device is designed to operate.

Voltage Regulation: Measure of change in voltage between no load and full load in terms of full load voltage.

Voltage Peak: Voltage or current of AC sinusoidal wave when it reaches its peak or maximum level twice in cycle. These peaks are only a point of each 1/2 cycle. Direct current voltage is really peak voltage at all times.

Watt (W or P): Unit of electrical power which represents amount of power of circuit when current in that circuit is 1 ampere and voltage is 1 volt.

OTHER SENSATA CATALOGS THAT MAY INTEREST YOU:



Klixon™ Thermal Circuit Breakers
Literature PN 2455009001

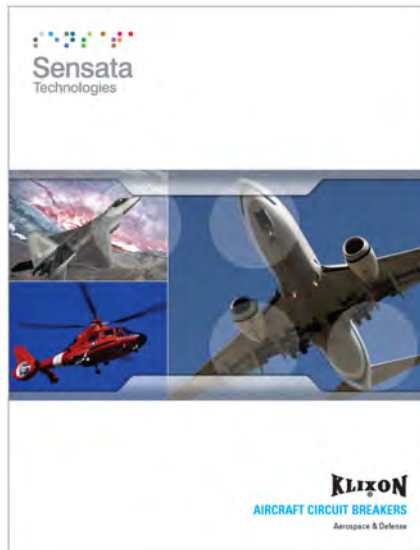

Klixon™ Aircraft Circuit Breakers
Literature PN 2455009002

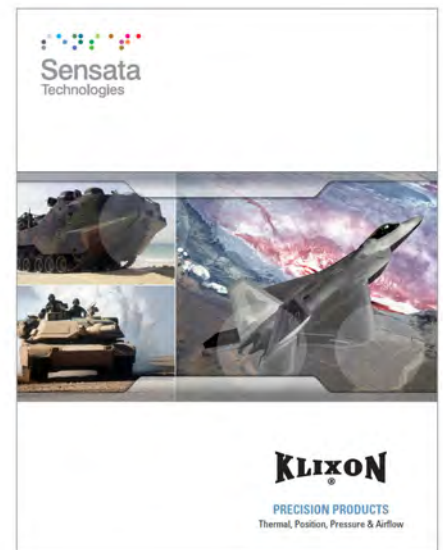

Klixon™ Precision Products
Literature PN 2455009004

©2014 Sensata Technologies, Inc. All rights reserved worldwide. **Literature # 2455005000**, printed in the USA, **September 2014**.

Important Notice: Sensata Technologies reserves the right to make changes to, or to discontinue, any product or service identified in this publication without notice. Before placing orders, users should obtain the latest version of the relevant information to verify that the information being relied upon is current.

Sensata Technologies assumes no responsibility for customers' product designs or applications. Users must determine the suitability of the Sensata device described in this publication for their application, including the level of reliability required. Many factors beyond Sensata's control can affect the use and performance of a Sensata product in a particular application, including the conditions under which the product is used and the time and environmental conditions in which the product is expected to perform. As these factors are uniquely within the user's knowledge and control, it is essential that the user evaluate the Sensata product to determine whether it is fit for a particular purpose and suitable for the user's application.

Sensata Technologies products are sold subject to Sensata's Terms and Conditions of Sale which can be found at: www.sensata.com/terms.htm



Sensata Technologies Inc.
529 Pleasant Street
Attleboro, MA 02703, USA
Phone: +1 508-236-3287