

NMOP-10123

SUPER BRIGHT ROUND TYPE LED LAMPS

Package Dimensions:

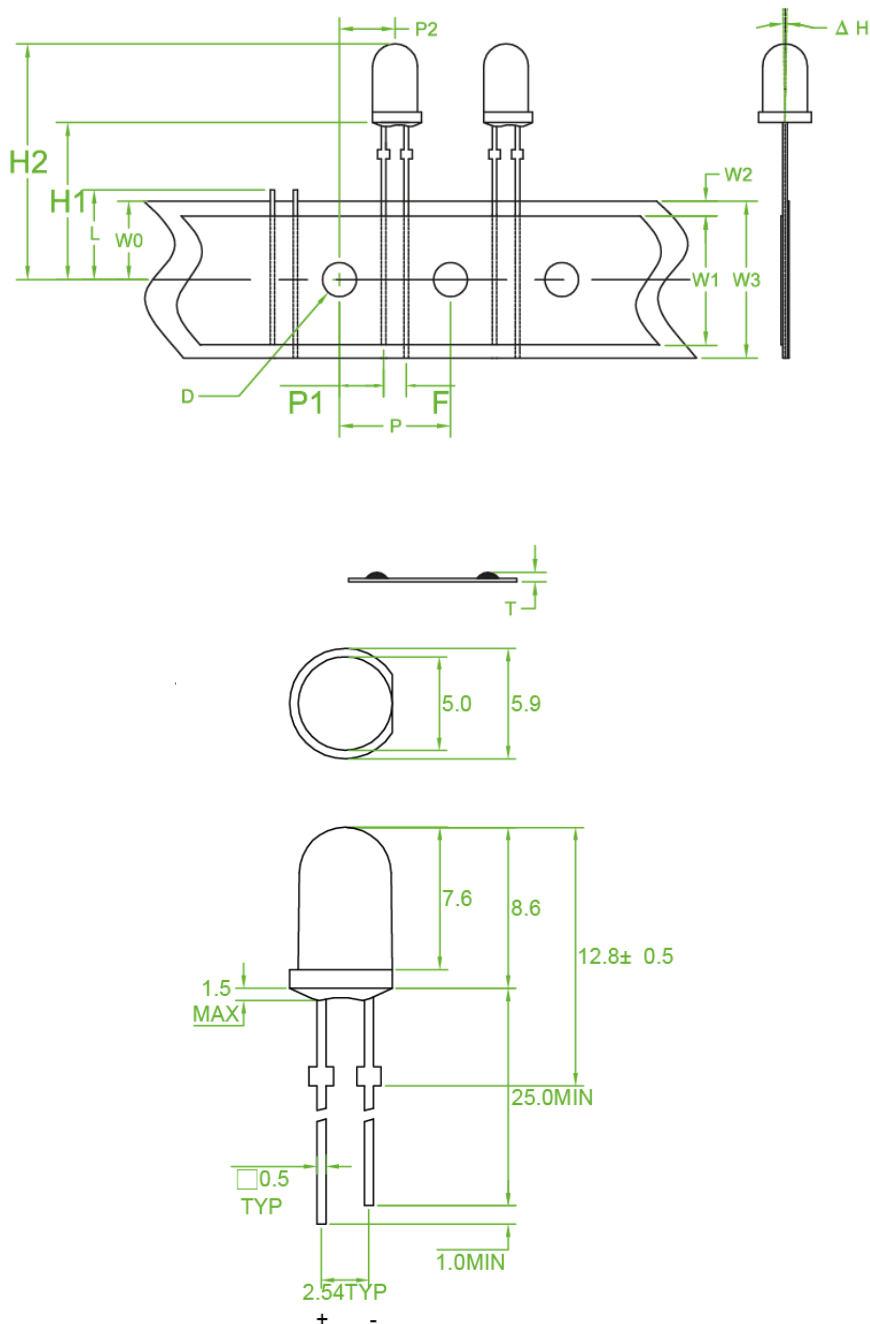

Note : 1.All dimension are in millimeter tolerance is ± 0.25 mm unless otherwise noted.
2.Specifications are subject to change without notice.

Absolute Maximum Ratings at Ta=25° C

Parameter	Symbol	Ratings	UNIT
		HRFS	
Forward Current	I_F	30	mA
Peak forward current Duty 1/10@10KHz	I_{FP}	60	mA
Power Dissipation	PD	72	mW
Reverse Current @5V	I_r	10	μ A
Electrostatic Discharge (*)	ESD	2000	V
Operating Temperature	T_{opr}	-40 ~ +85	°C
Storage Temperature	T_{stg}	-40 ~ +100	°C

* Static Electricity or power surge will damage the LED. Use of a conductive wrist band or anti-electrostatic glove is recommended when handling these LED. All devices, equipment and machinery must be properly grounded.

Typical Electrical & Optical Characteristics (Ta=25° C)

Part No	Material	Color		Dominant wavelength λ_{Dnm}	Spectral halfwidth $\Delta\lambda$ nm	Forward voltage @20mA(V)		Luminous intensity @20mA(mcd)		Viewing angle 2 θ 1/2 (deg)
		Emitted	Lens			Min.	Max.	Min.	Max.	

Note:

1. The forward voltage data did not including $\pm 0.1V$ testing tolerance
2. The luminous intensity data did not including $\pm 15\%$ testing tolerance.

Brightness Code for Standard LED Lamps

Bin CHIP

Group	Luminous Intensity (mcd) at 20mA	
	Min.	Max.
A29	5.000	6.200
A30	6.200	7.700
A31	7.700	9.500
A32	9.500	11.500
A33	11.500	14.000
A34	14.000	17.000

Color Code

HRF(S) CHIP

Group	Wavelength (nm) at 20mA	
	Min.	Max.
25	612	615
26	615	620
27	620	625
28	625	630
29	630	636

HRF(S) CHIP

Group	Forwardvoltage(V) at 20mA	
	Min.	Max.
V1	1.7	1.8
V2	1.8	2.0
V3	2.0	2.2
V4	2.2	2.4
V5	2.4	2.6

Dimensions Symbol Information

SYMBOL ITEMS	OPTION CODE	SYMBOL	SPECIFICATIONS			
			Minimum		Maximum	
			mm	inch	mm	inch
Tape Feed Hole Diameter		D	3.8	0.15	4.2	0.17
Component Lead Pitch		F	2.3	0.09	3.0	0.12
Front-To-Rear Deflection		Li H			2.0	0.08
Feed Hole To Bottom Of Component	TRS-1	H1	17.5	0.69	18.5	0.73
	TRS-2		21.5	0.85	22.5	0.89
	TRS-3		25.5	1.0	26.5	1.04
	TRS-4		27.5	1.08	28.5	1.12
	TRS-5		22.5	0.89	23.5	0.93
	TRS-6		19.9	0.78	20.9	0.82
	TRS-7		24.0	0.94	25.0	0.98
	TRS-8		24.5	0.96	25.5	1.0
	TRS-9		19.0	0.75	20.0	0.79
	TRS-10		18.4	0.72	19.4	0.76
Feed Hole To Overall Component Height		H2			36	1.42
Lead Length After Component Height		L	wo		11.0	0.43
Feed Hole Pitch		P	12.4	0.49	13.0	0.51
Lead Location		P1	4.4	0.17	5.8	0.23
Center Of Component Location		P2	5.1	0.2	7.7	0.3
Overall Taped Package Thickness		T			1.42	0.06
Feed Hole Location		W0	8.5	0.33	9.75	0.38
Adhesive Tape Width		W1	14.5	0.57	15.5	0.61
Adhesive Tape Position		W2	0	0	4.0	0.16
Tape Width		W3	17.5	0.69	19.0	0.75

Remark: TRS = Tape and Reel Straight Leads

Dimensions Symbol Information

Description	Symbol	Specification			
		minimum		maximum	
		mm	inch	mm	inch
Overall Length	I	330	13.0	340	13.4
Overall Width	W	265	10.4	275	10.8
Overall Thickness	H	50	1.97	60	2.4
Part No.	Quantity/Box				
NMOP-10123	2000PCS				

Package Dimensions

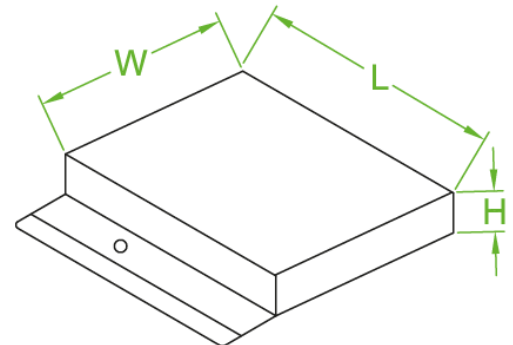

Typical Electro-Optical Characteristics Curve

HRFS CHIP

Fig.1 Forward current vs. Forward Voltage

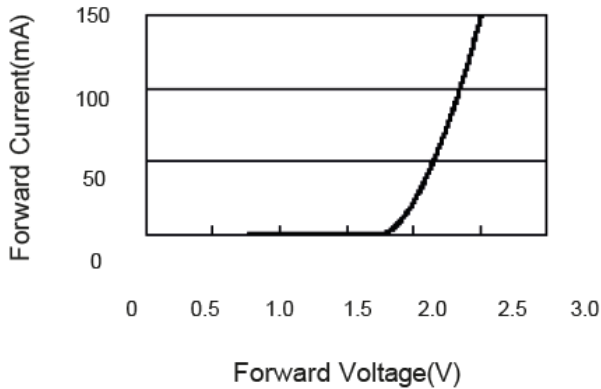

Fig.2 Luminous Intensity vs. Forward Current

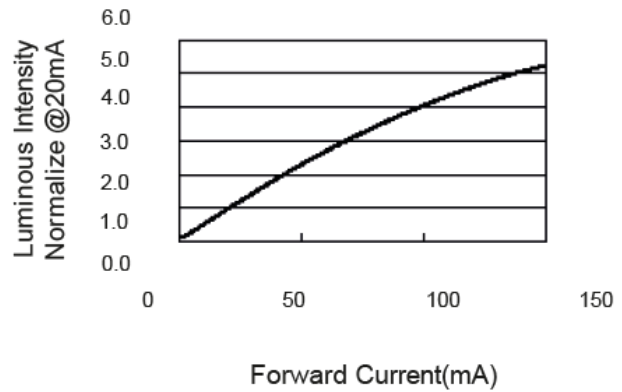

Fig.3 Forward Voltage vs. Temperature

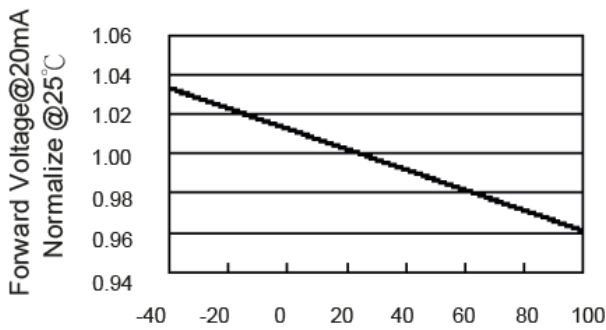

Fig.4 Luminous Intensity vs. Temperature

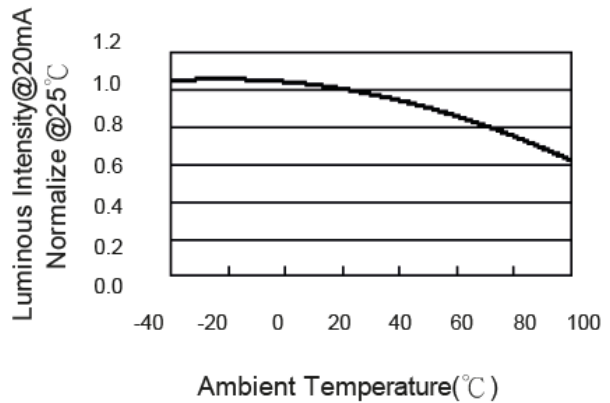
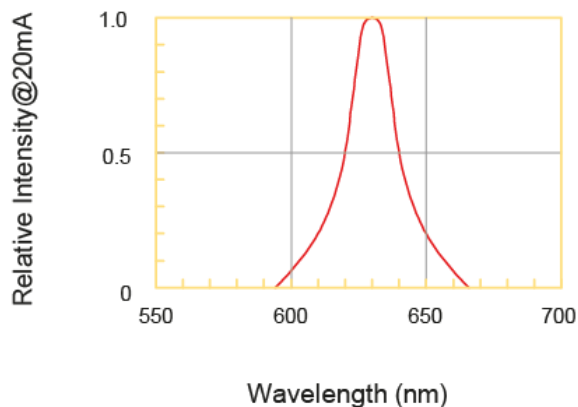

Fig.5 Relative Intensity vs. Wavelength



Soldering Condition(Pb-Free)

1. Iron:

Soldering Iron: 30W Max.
Temperature: 350°C Max
Soldering Time: 3 Seconds Max (One Time only)
Distance: 2mm Min (from solder joint to body)

2. Wave Soldering Profile

Dip Soldering
Preheat: 120°C Max.
Preheat time: 60 seconds Max.
Ramp-up: 2°C/sec (max)
Ramp-Down: -5°C/sec. (max)
Solder Bath: 260°C Max
Dipping Time: 3 seconds Max.
Distance: 2mm Min (From solder joint to body)

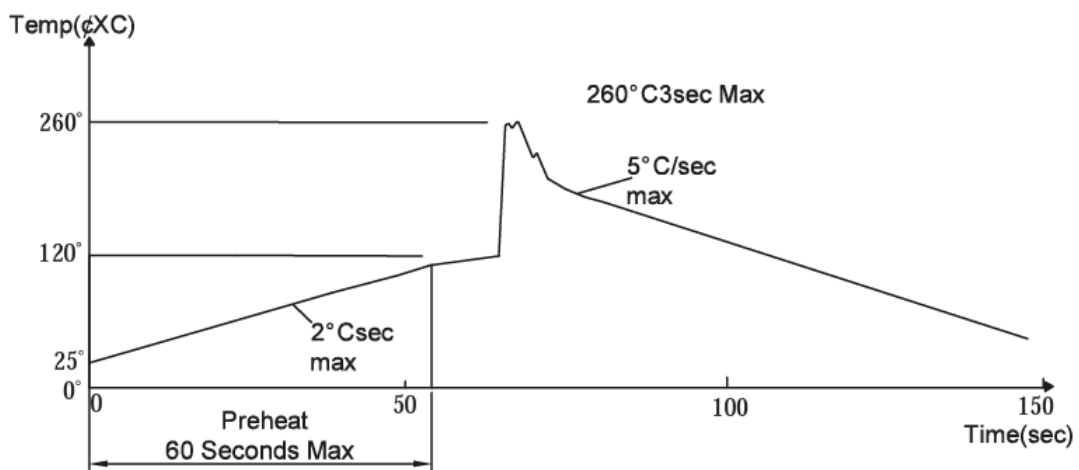

Note: 1. Wave solder should not be made more than one time.
2. You can just only one of the soldering conditions as above.

Reliability Test:

Test Item	Test Condition	Description	Reference Standard
Operating Life Test	1. Under Room Temperature 2. If=20mA 3. t=1000 hrs (-24hrs,+72hrs)	This test is conducted for the purpose of determining the resistance of a part in electrical and thermal stressed.	MIL-STD-750: 1026 MIL-STD-883: 1005 JIS C 7021: B-1
High Temperature Storage Test	1. Ta=105°C±5°C 2. t=1000 hrs (-24hrs,+72hrs)	The purpose of this is the resistance of the device which is laid under condition of high temperature for hours.	MIL-STD-883: 1008 JIS C 7021: B-10
Low Temperature Storage Test	1. Ta=-40°C±5°C 2. t=1000 hrs (-24hrs,+72hrs)	The purpose of this is the resistance of the device which is laid under condition of low temperature for hours.	JIS C 7021: B-12
High Temperature High Humidity Storage Test	1. Ta=65°C±5°C 2. RH=90%~95% 3. t=24hrs ±2hrs	The purpose of this test is the resistance of the device under tropical for hours.	MIL-STD-202: 103B JIS C 7021: B-11
Thermal Shock Test	1. Ta=105°C±5°C & -40°C±5°C (10min) (10min) 2. total 10 cycles	The purpose of this is the resistance of the device to sudden extreme changes in high and low temperature.	MIL-STD-202: 107D MIL-STD-750: 1051 MIL-STD-883: 1011
Solder Resistance Test	1. T.Sol=260°C±5°C 2. Dwell time = 10±1sec.	This test is intended to determine the thermal characteristic resistance of the device to sudden exposures at extreme changes in temperature when soldering the lead wire.	MIL-STD-202: 210a MIL-STD-750: 2031 JIS C 7021: A-1
Solderability Test	1. T.Sol=245°C±5°C 2. Dwell time = 5±1sec.	This test is intended to see if soldering is well performed or not.	MIL-STD-202: 208D MIL-STD-750: 2026 MIL-STD-883: 2003 JIS C 7021: A-2